

FT-736R

TECHNICAL SUPPLEMENT

YAESU MUSEN CO., LTD.
C.P.O. BOX 1500
TOKYO, JAPAN

FT-736R TECHNICAL SUPPLEMENT



This manual is intended to serve as a supplement to the FT-736R Operating Manual. Detailed information regarding functions, installation, interconnections and operation has been provided in the Operating Manual, and is not reprinted herein. Therefore, this supplement is not intended to serve as an independent reference, but to be used in conjunction with the information provided in the Operating Manual.

Because there are nearly five hundred semiconductor devices in the FT-736R, circuit description information is provided in the form of numerous block diagrams. We hope that this manner of providing functional information proves to be more convenient for the owner and technician than would a lengthy verbal description. Those readers unfamiliar with the basic types of analog and digital circuits that serve as the building blocks of the FT-736R are encouraged to study instructional material, such as that provided in handbooks on amateur radio and digital circuit design, before attempting to understand the design of the FT-736R. Each block in the block diagrams represents one such basic circuit, while the Component Applications List provides additional details for each semiconductor. General information on integrated circuits and their applications is available in the data provided by the IC manufacturers. Specific circuit details are provided in the schematic diagrams in this manual.

While we believe the technical information in this manual is correct, Yaesu assumes no liability for damage that may occur as a result of typographical or other errors that may be present. Your cooperation in pointing out any inconsistencies in the technical information would be appreciated.

Yaesu Musen reserves the right to make changes in the circuitry of this transceiver, in the interest of technological improvement, without obligation to notify owners or to modify any sets produced prior to the modification.

CONTENTS

CIRCUIT BOARD ACCESS	1
RX UNIT PARTS LAYOUT.....	3
RX UNIT CIRCUIT DIAGRAM	5
TX UNIT PARTS LAYOUT	6
TX UNIT CIRCUIT DIAGRAM	8
AF UNIT PARTS LAYOUT/CIRCUIT DIAGRAM.....	9
144MHz MAIN UNIT PARTS LAYOUT	10
144MHz MAIN UNIT CIRCUIT DIAGRAM	12
430MHz RF UNIT PARTS LAYOUT	13
430MHz RF UNIT CIRCUIT DIAGRAM	15
430MHz PLL UNIT PARTS LAYOUT	16
430MHz PLL UNIT CIRCUIT DIAGRAM	17
CNTL UNIT PARTS LAYOUT	18
CNTL UNIT CIRCUIT DIAGRAM	20
DISPLAY, REG and PROTECTOR UNIT PARTS LAYOUT	21
DISPLAY CIRCUIT DIAGRAM	23
SW, ENCODER and VR UNIT PARTS LAYOUT	24
CONNECTION DIAGRAM	25
BLOCK DIAGRAM	26
SIGNAL TRACING (SSB MODE)	27
SIGNAL TRACING (CW MODE)	28
SIGNAL TRACING (FM MODE)	29
SEMICONDUCTOR CROSS-REFERENCE	30
EXPLODED VIEW	31
50MHz BAND MODULE (FEX-736-50) OPTION	33
220MHz BAND MODULE (FEX-736-220) OPTION	39
1200MHz BAND MODULE (FEX-736-1.2) OPTION	45
LEVEL DIAGRAM (144MHz RX)	51
LEVEL DIAGRAM (430MHz RX)	52
LEVEL DIAGRAM (144MHz TX)	53
LEVEL DIAGRAM (430MHz TX)	54
ALIGNMENT.....	55
ALIGNMENT (PLL)	57
ALIGNMENT (Transmitter)	60
ALIGNMENT (Receiver)	64
ALIGNMENT (FEX-736-50)	69
ALIGNMENT (FEX-736-220)	72
ALIGNMENT (FEX-736-1.2)	76
PARTS LIST	81

CIRCUIT BOARD ACCESS

TOP COVER

The following units (pcb's) are accessed by removing the top cover:

- TX Unit
- 144 MHz Main Unit
- 144 & 430 MHz PA Units
- 430 MHz PLL Unit
- 430 MHz RF Unit
- 430 MHz Front End Unit
- AF Unit
- Protector Unit
- 1/2 of RX Unit

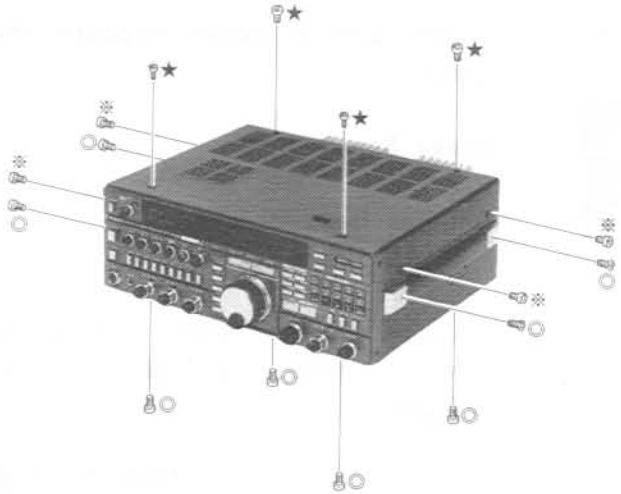

Figure 1

To remove the top cover, remove the eight screws (4 each marked "★" or "※") in Figure 1). Then lift the cover off slowly so as not to stress the loudspeaker wires. Unplug these wires from J3016 on the RX Unit before pulling the cover away.

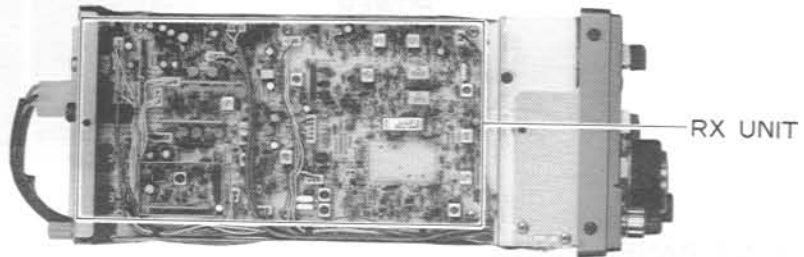

Figure 2

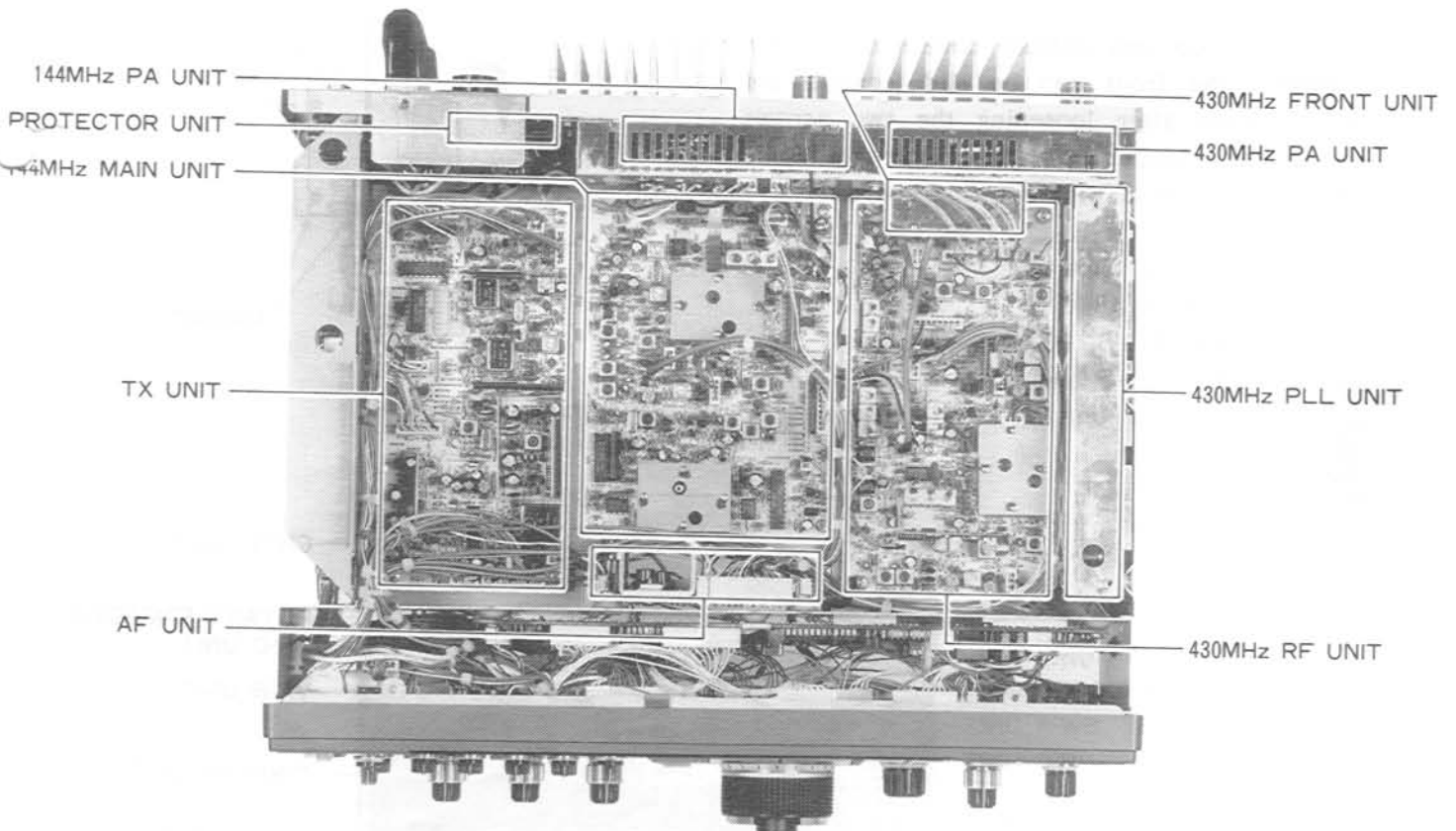

Figure 3

CIRCUIT BOARD ACCESS

BOTTOM COVER

Removing the bottom cover exposes the following units:

- Power Supply Unit
- Reg Unit
- Optional Band Modules
- ½ of RX Unit

To remove the bottom cover, remove the twelve screws (4 marked "※" and 8 marked "◎") in Figure 1).

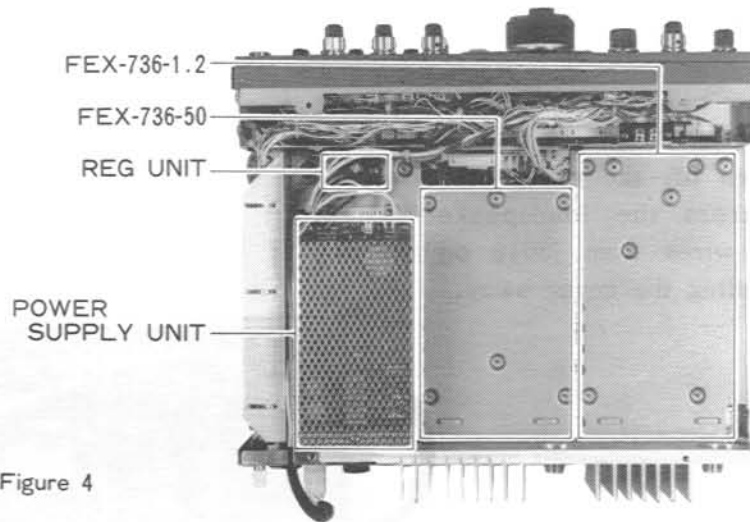

Figure 4

FRONT PANEL HINGE

When the top and bottom covers have been removed, the front can be slid forward and folded down after loosening the two screws on either side, shown in Figure 5. This provides access to the following boards:

- Control Unit
- Display Unit
- VR-A, -B, -C and -D Units
- SW-A, -B and -C Unit
- Encoder Unit

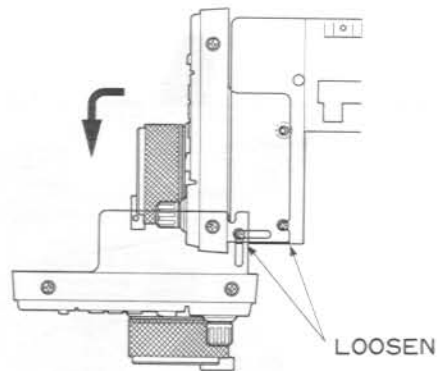
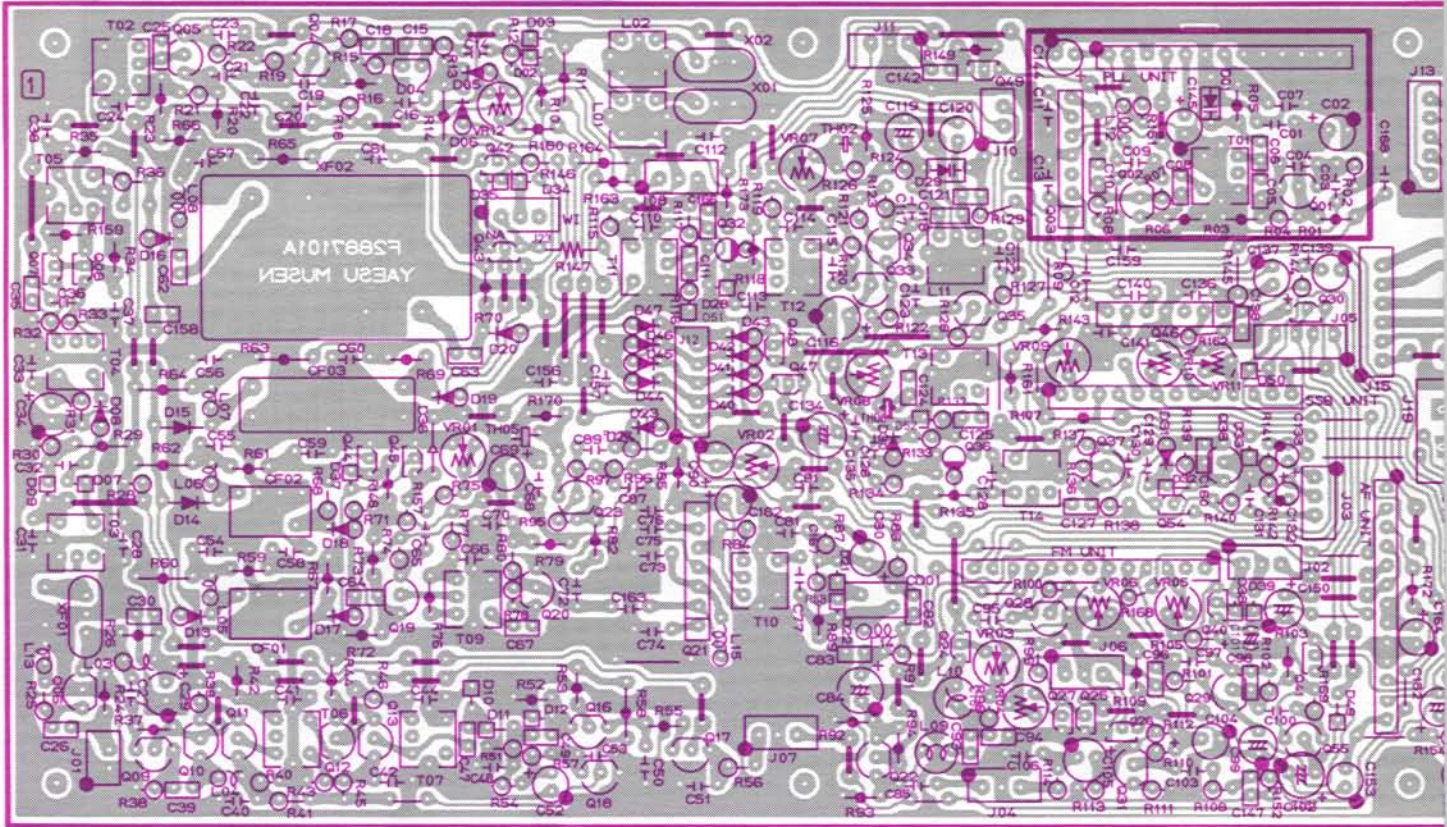

Figure 5



Figure 6

RX UNIT (No. 3XXX)



Component side



Component side

RX UNIT PARTS LAYOUT

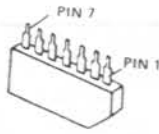

μPC1037H(Q3003,3046)

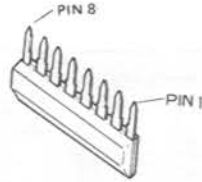

μPC577H(Q3021)

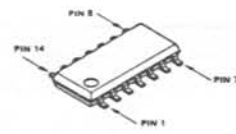

LA6324M(Q9301,9401)

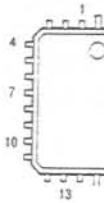

MC145163SL(Q9801)

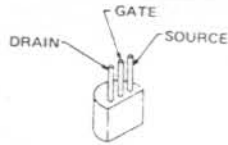

2SK125(Q3006)

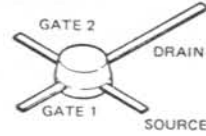

3SK74L(Q3032,3036)

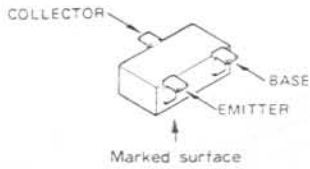

2SC2619F(FB) (Q9802,9803)
2SC2712GR(LG)
(Q9001,9003,9005)
FA1A4M(L33) (Q9402,9403)
FA1F4N(L35) (Q9002,9004)

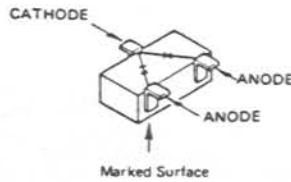

1SS184(B3) (Q9301,9401)

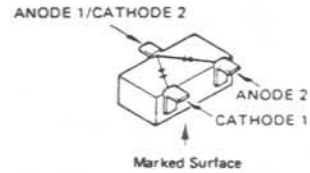

1SS226(C3) (Q9302)

(obverse)

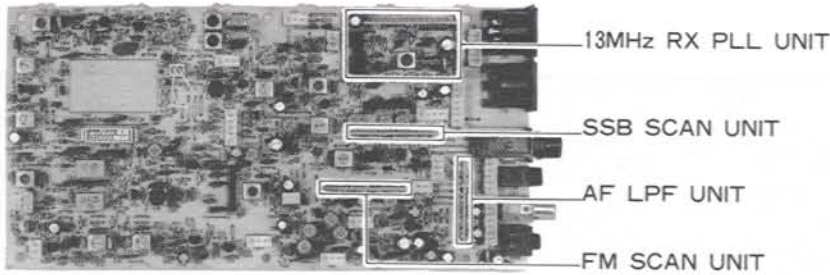

AF LPF UNIT (No.90××)

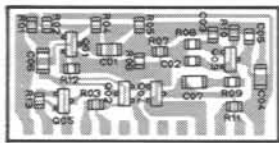

① ④ ⑦ ⑩ ⑬

Solder side (obverse)

SSB SCAN UNIT (No. 93××)

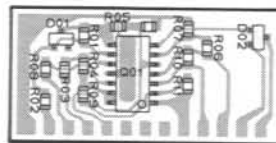

① ④ ⑦ ⑩ ⑬

Solder side (obverse)

FM SCAN UNIT (No. 94××)

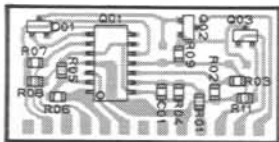

① ④ ⑦ ⑩ ⑬

Solder side (obverse)

13MHz RX PLL UNIT (No. 98××)

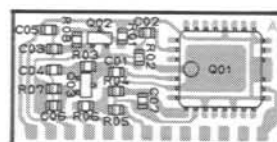

① ④ ⑦ ⑩ ⑬

Solder side (obverse)

(reverse)

S)

/MIN

SIG.)

SIG.)

SIG.)

-CW

V

M-N

M-N

F

F

RX UNIT PARTS LAYOUT

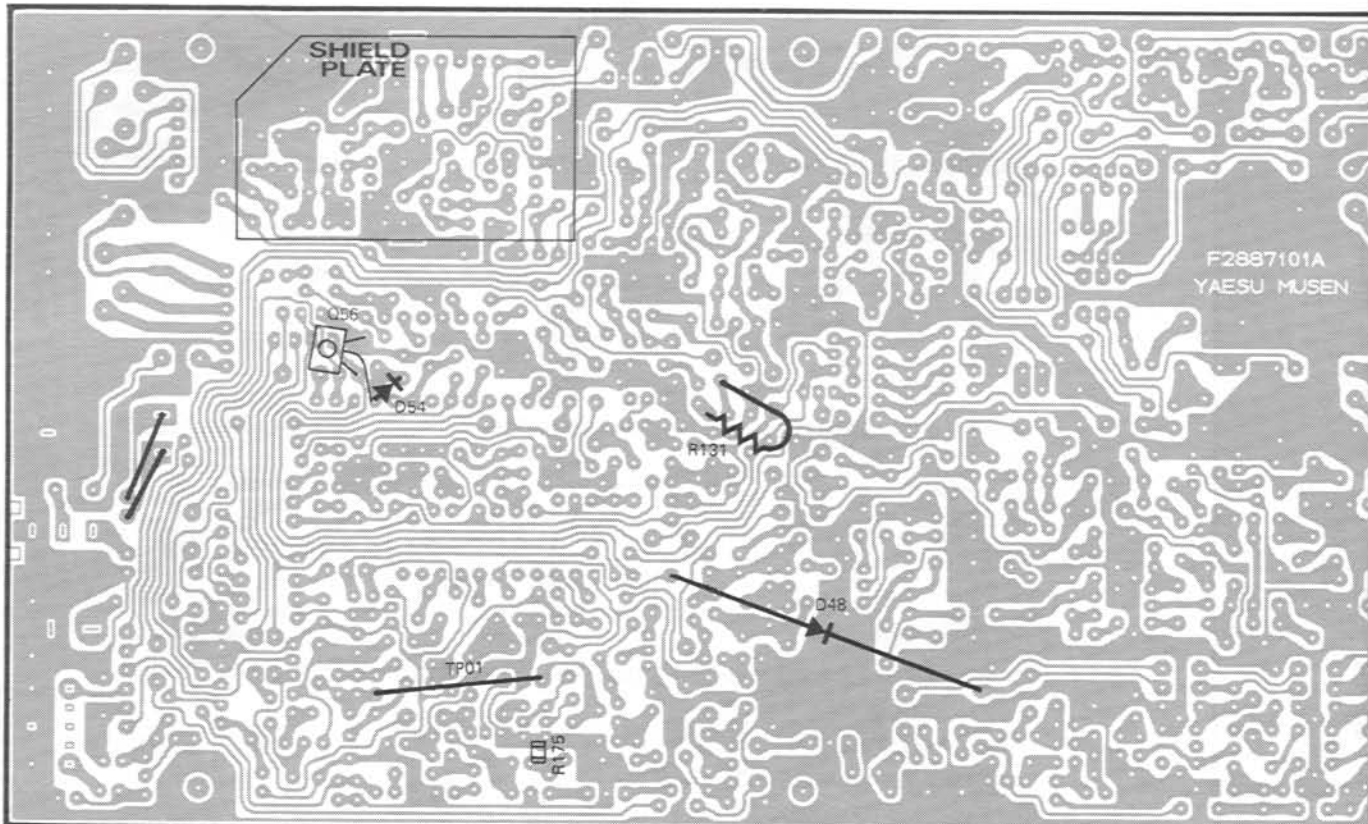

Componen

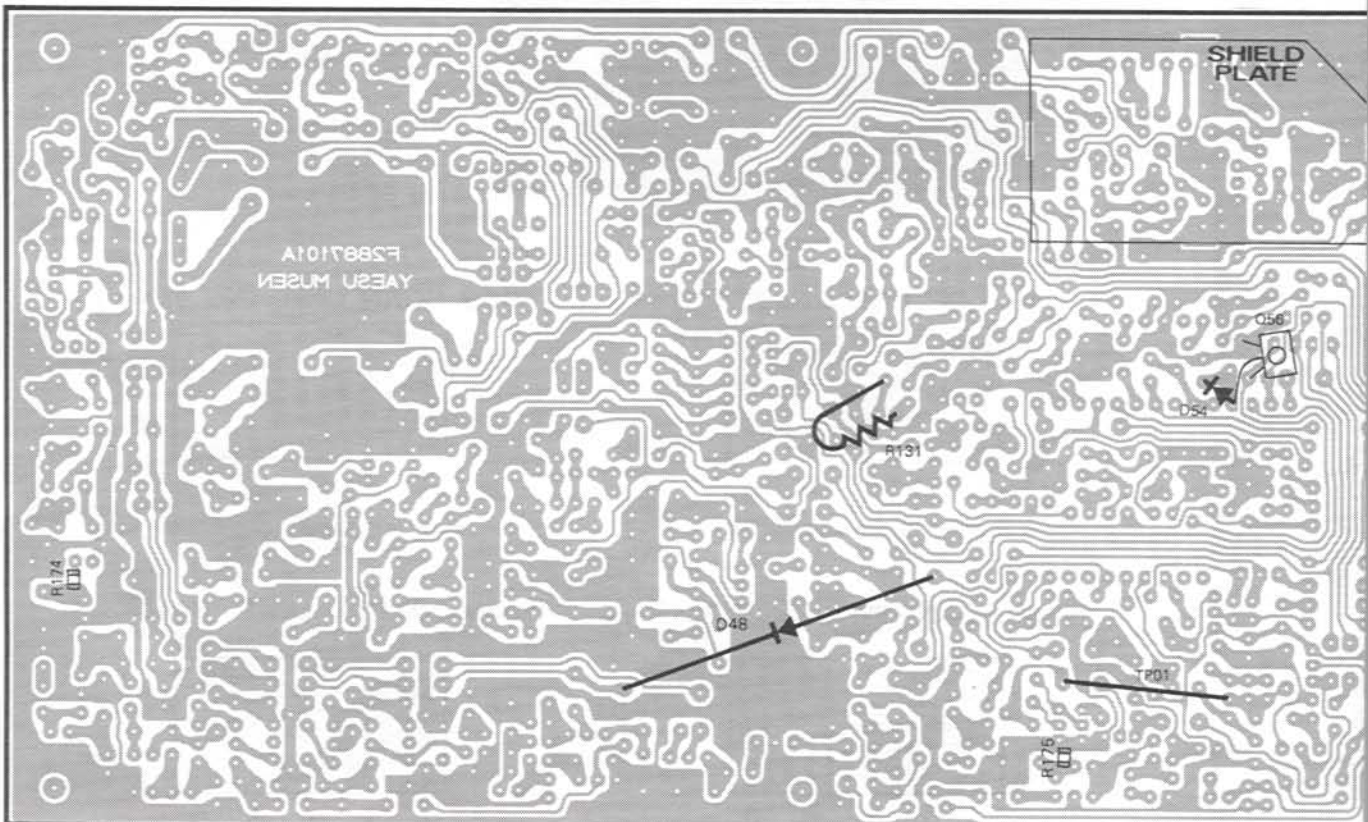

Componen

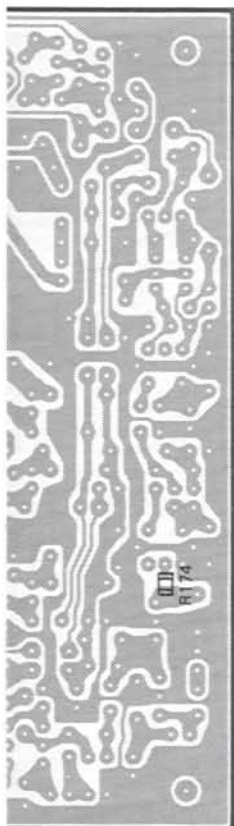

Reverse side (obverse)

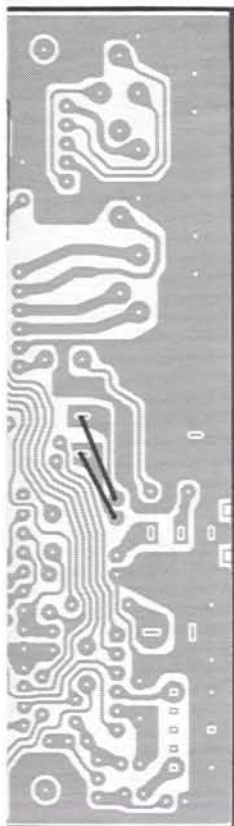

Reverse side (reverse)

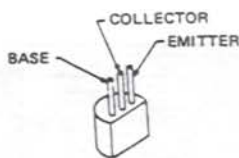

2SA460B(Q3002,3044)
 2SA733AP(Q3055)
 2SC458C
 (Q3010-3013,3016-3018)
 (3020,3022,3023,3028)
 (3029,3031,3033-3035)
 (3037-3039)
 2SC535B
 (Q3001,3005,3009,3019)

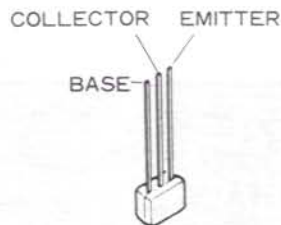

BA1A4M(Q3030)
 BA1A4P
 (Q3024-3027,3040,3041)
 (3054,3056)
 BA1L4L
 (Q3042-3045)
 BN1A4P(Q3047,3048)

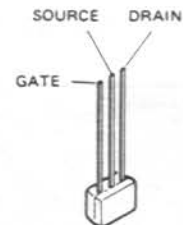

2SK241GR
 (Q3007,3008,3049)

RX UNIT VOLTAGE CHART

(DC VOLTS)

	E(S)	C(D)	(G ₁) ^B	(G ₂)	REMARKS		E(S)	C(D)	(G ₁) ^B	(G ₂)	REMARKS
Q3001	3.06	7.60	3.70			Q3029	0.03	0.02	0.02		FM
Q3002	3.6	1.30	2.00			Q3030	0	4.0/0	0/6.7		FM SOLVR MAX/MIN
Q3004	3.0	7.80	3.60			Q3031	0.84	3.60	1.49		FM
Q3005	0.67	7.60	1.40			Q3032	0.75	6.65	0.85	2.45	SSB-CW (No SIG.)
Q3006	0	7.70	1.20			Q3033	4.50	7.60	5.10		SSB-CW
Q3007	0.85	7.60				Q3034	4.50	6.10	5.00		SSB-CW
Q3008	0.85	7.60				Q3035	4.00	7.60	4.65		SSB-CW
Q3009	3.42	7.50	3.48			Q3036	0.75	6.70	0.84	2.42	SSB-CW (No SIG.)
Q3010	1.95	7.50	2.60			Q3037	4.70	7.65	5.30		SSB-CW
Q3011	1.95	7.50	2.60			Q3038	0	2.43	0.05		SSB-CW (No SIG.)
Q3012	1.95	7.60	2.60			Q3039	3.0	7.7	3.7		
Q3013	1.95	7.60	2.60			Q3040	0	0	7.5		
Q3016	0	7.8/0			NB ON/OFF	Q3041	0	0.01	4.77		
Q3017	0	4.45				Q3042	0	7.80/0.06	0.06/5.10		CW-N / CW-N
Q3018	0	5.30	0.28			Q3043	0	7.80/0.06	0.06/5.10		SSB-CW / SSB-CW
Q3019	1.16	7.70	1.83		FM	Q3044	0	7.80/0.06	0.60/5.20		FM-N / FM-N
Q3020	0	3.75	0.68		FM	Q3045	0	7.80/0.06	0.06/2.70		FM-W / FM-W
Q3022	1.40	7.70	2.02		FM	Q3047	7.86	7.71/0.01	0.06/7.82		FM FM-N / FM-FM-N
Q3023	0.30	2.80	1.00		FM	Q3048	7.86	0.08/7.52	7.83/0.60		FM FM-N / FM-FM-N
Q3024	0	0	2.20/0		FM / FM	Q3049	0	3.14	0		
Q3025	0	0.01	4.76		FM	Q3054	0	0.01/0.04	4.84/0.01		MUTE ON/OFF
Q3026	0	0.02	4.76		FM	Q3055	7.50	0.07	7.45		FM
Q3027	0	0.02	0.01		FM	Q3056	0	0.10/1.63	4.84/0.01		MUTE ON/OFF
Q3028	0	0.02	0.02		FM						

RX UNIT IC VOLTAGE CHART

(DC VOLTS)

	1	2	3	4	5	6	7	REMARKS
Q3003	7.00	6.15	—	0	3.11	3.11	3.11	
Q3021	5.10	1.90	1.90	0	7.60	2.80	7.00	FM
Q3046	6.94	6.09	—	0	3.07	3.07	3.07	

RX UNIT F2687101 (No.3xxx)

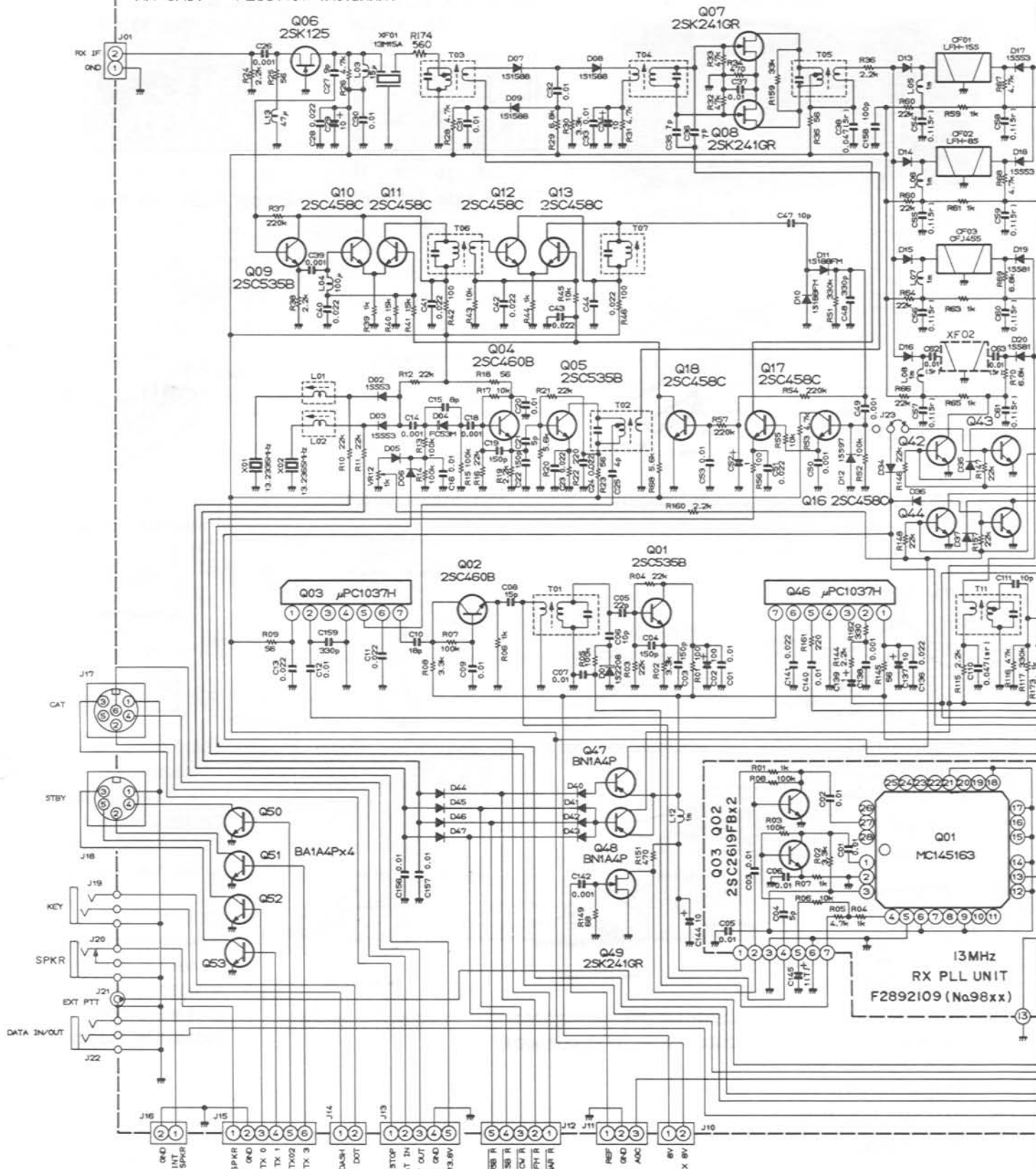

RESISTOR VALUES ARE IN Ω, 1/8W;
 CAPACITOR VALUES ARE IN μF;
 INDUCTOR VALUES ARE IN HENRIES, UNLESS OTHERWISE NOTED.
 DIODES ARE TYPE 1S5270 UNLESS OTHERWISE NOTED.
 15p CAPACITORS ARE SEMICONDUCTOR CERAMIC, 25V.
 (T) CAPACITORS ARE TANTALUM.

TX UNIT PARTS LAYOUT

TX UNIT (No. 4XXX)

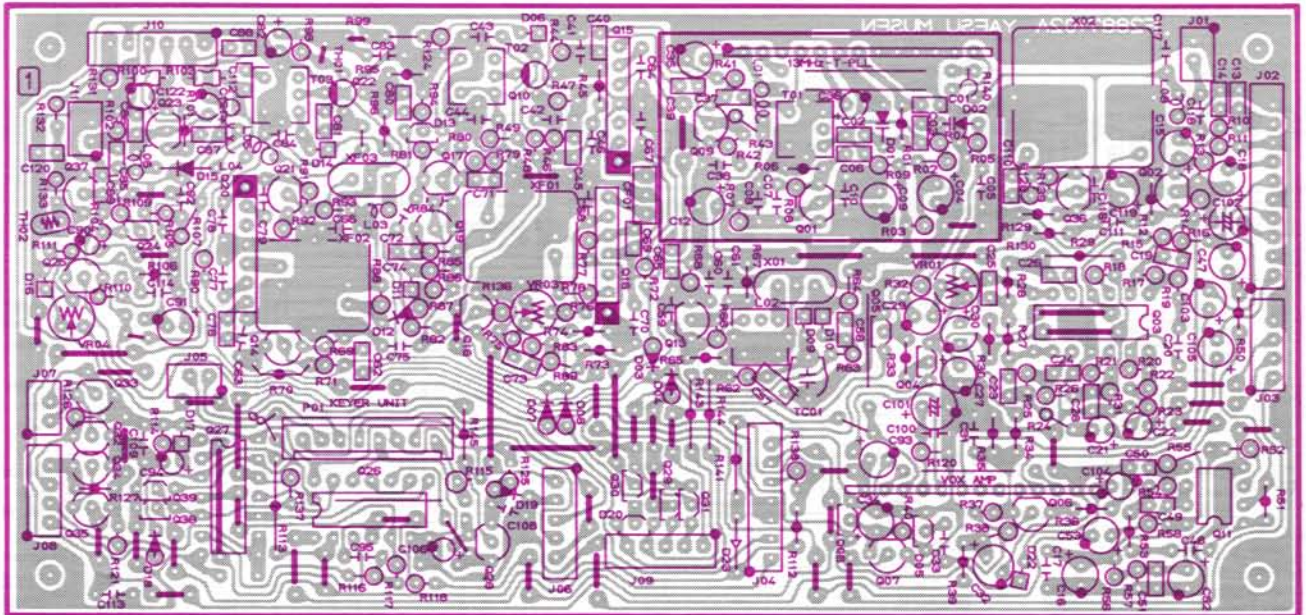

Component side (obverse)

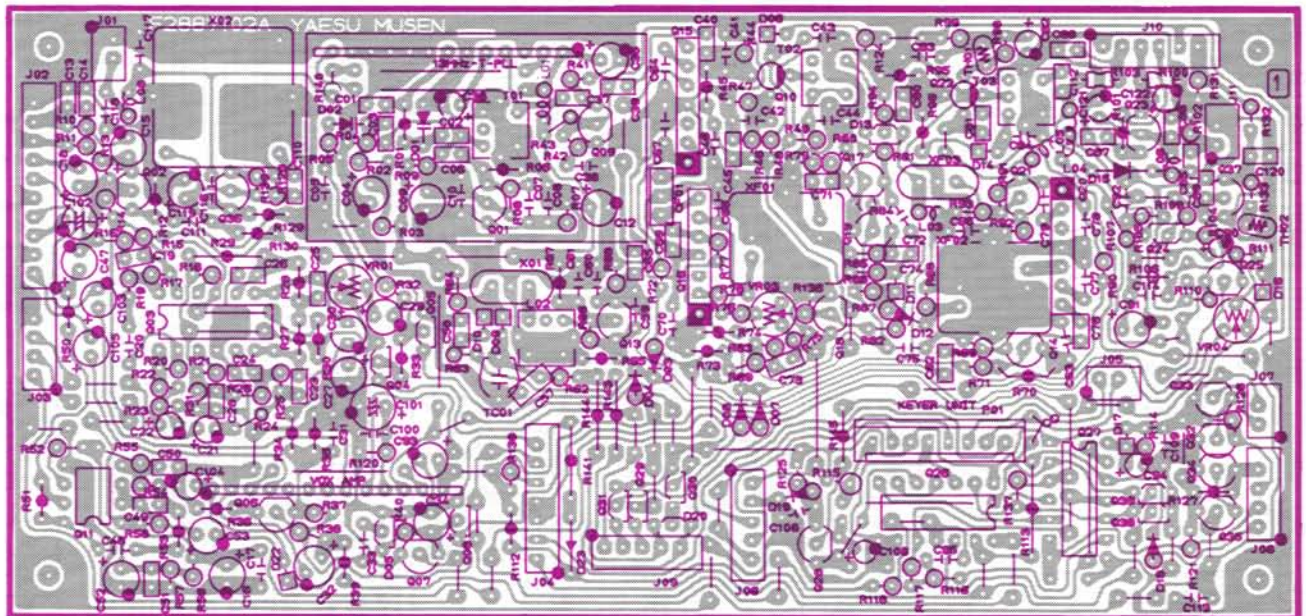

Component side (revers)

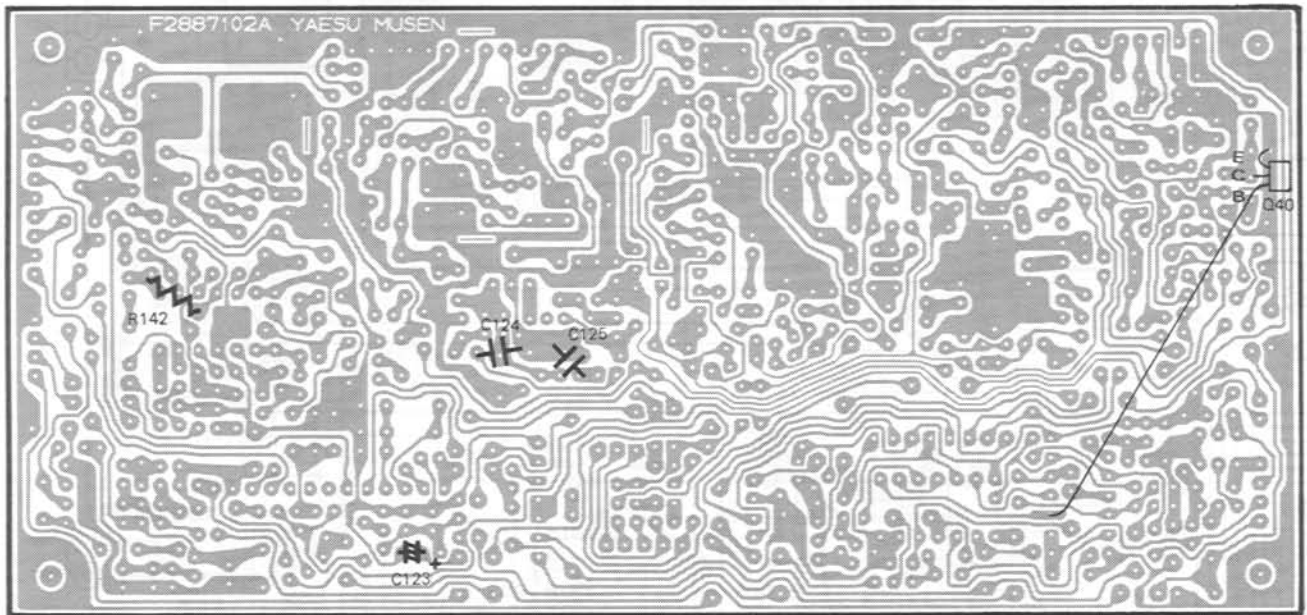

Solder side (obverse)

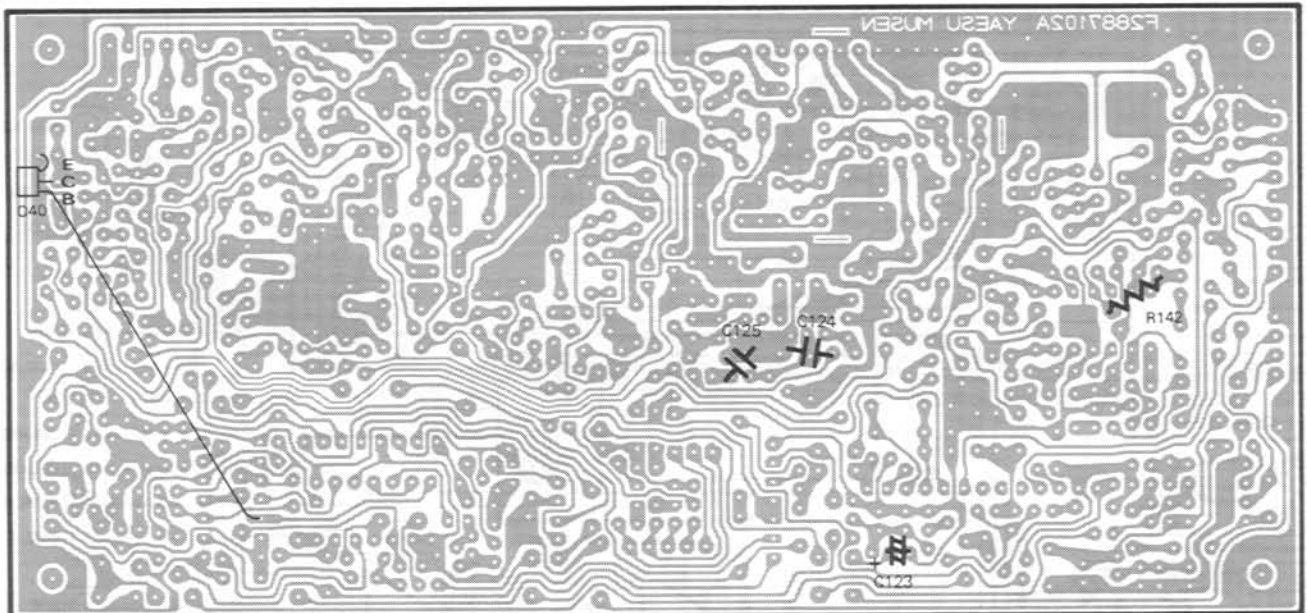

Solder side (reverse)

TX UNIT PARTS LAYOUT

TX UNIT VOLTAGE CHART

(DC VOLTS)

	E(S)	C(D)	(G ₁)	^B (G ₂)	REMARKS		E(S)	C(D)	(G ₁)	^B (G ₂)	REMARKS
Q4001	2.8	7.5	3.4			Q4023	0	7.6	0		
Q4002	3.42	7.41	4.11			Q4024	2.69	7.88	0.99		CW ALC/DISC @ 10W output
Q4004	0	0	4.96/0.04		SSB-CW / FM-N FM / CW-N	Q4025	3.30	1.74	2.70		
Q4005	0	0	7.2/0		SSB CW / FM	Q4028	0.62/0.79	3.30/0	0.01/1.75		CW KEY UP/DOWN
Q4006	0.14/0.16	4.35/3.90	0.80/0.55		with MIC input / without MIC input	Q4029	7.90	7.85/0	0/7.85		SSB / SSB
Q4007	0	12.10/0.20	0.42/0.78		with MIC input / without MIC input	Q4030	7.90	7.85/0	0.70/7.90		CW CW-N / CW,CW-N
Q4008	0	0.43/0.78	0		with MIC input / without MIC input	Q4031	7.90	7.80/0.01	0/7.80		FM,FM-N/FM,FM-N
Q4009	1.3	3.5	2.0			Q4032	0	7.87/0.02	0.01/0.074		TX / RX
Q4010	0	7.0	1.5	2.0		Q4033	7.90	0.03/0.02	7.90/7.80		TX / RX
Q4013	2.85	7.72	3.47		SSB	Q4034	0	7.90/0	0/0.75		TX / RX
Q4014	1.30	3.57	1.96		SSB	Q4035	7.90	0.02/0	7.90/0		TX / RX
Q4017	0.8	3.5	1.4		SSB	Q4036	3.4	7.4	4.1		
Q4018	0	0/0.06	0/0.69		SSB, PROC OFF/ON	Q4037	0	1.08	0.48		@ 10W output
Q4019	2.82	7.30	3.52		SSB	Q4038	0	7.70/0	0.04/7.10		CW KEY UP/DOWN
Q4021	1.40	5.27	2.06		SSB	Q4039	0	0.04/7.10	4.15/0		CW KEY UP/DOWN
Q4022	0	7.13	1.43	2.68	DRIVE control CCW	Q4040	0	0	0/7.70		TX / RX

TX UNIT IC VOLTAGE CHART

(DC VOLTS)

	1	2	3	4	5	6	7	8	9	10	11	12	13	14	REMARKS
Q4003	2.77	2.78	2.76	6.76	2.80	2.81	2.81	2.81	2.81	2.35	0	2.77	2.77	2.76	
Q4011	2.80	2.80	2.80	0	2.35	2.82	2.82	6.75							SSB
Q4015	7.00	6.10	-	0	3.05	3.05	3.05								SSB
Q4016	7.0	6.1	-	0	3.1	3.1	3.1								SSB
Q4020	6.90	6.10	-	0	3.05	3.05	3.05								SSB
Q4026	L/L	H/L	L/L	L/H	H/H	L/L	0	L/L	H/L	L/H	H/L	L/L	L/H	7.90	CW KEY UP/DOWN H \div 8.0 L \div 0
Q4027	L/H	H/L	L/H	L/3.81	H/H	L/3.67	0	L/H	H/H	L/L	H/H	L/H	L/L	7.90	

AMP

TR

2

1

ONE

2

1

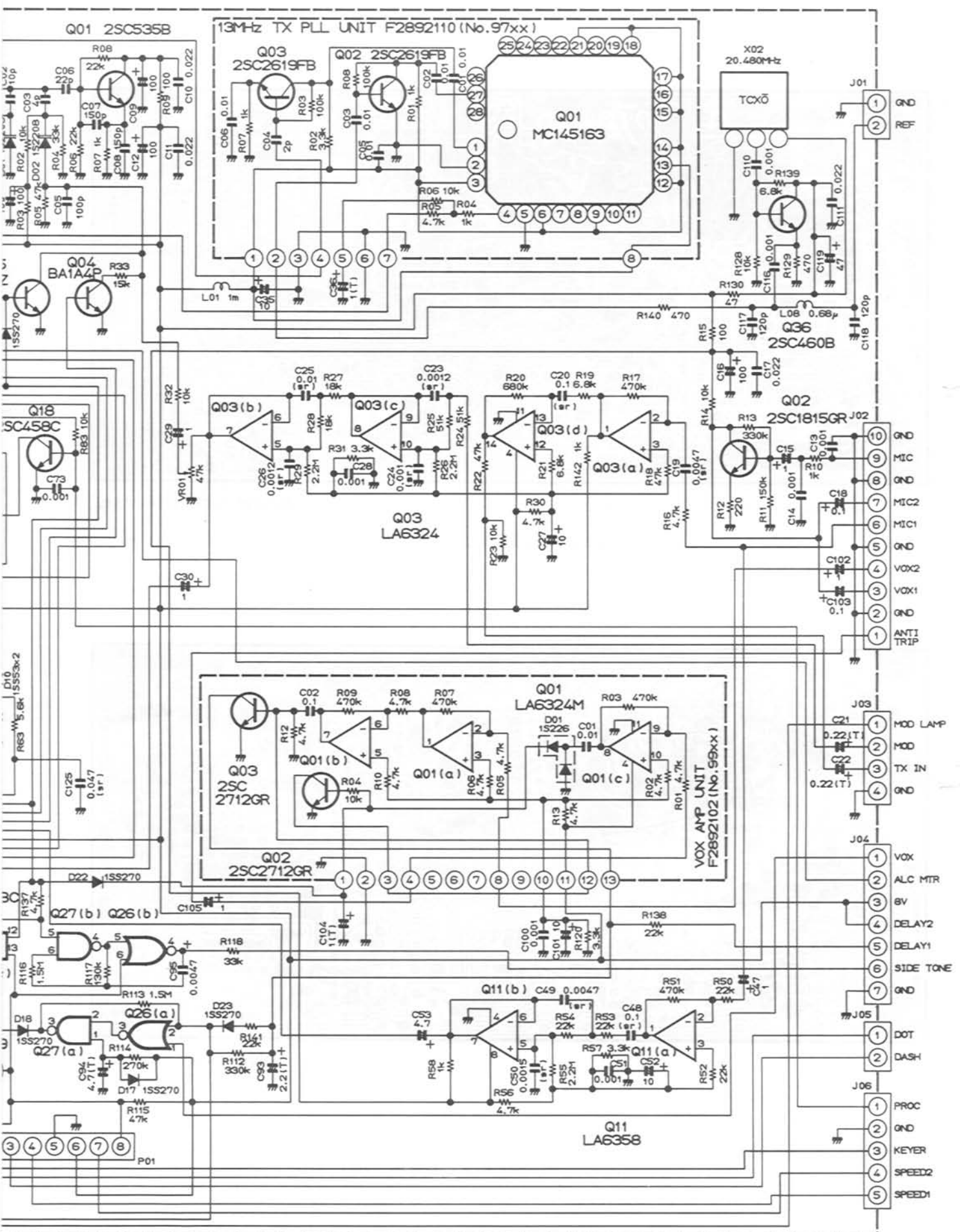

AF UNIT (No. 5XXX)

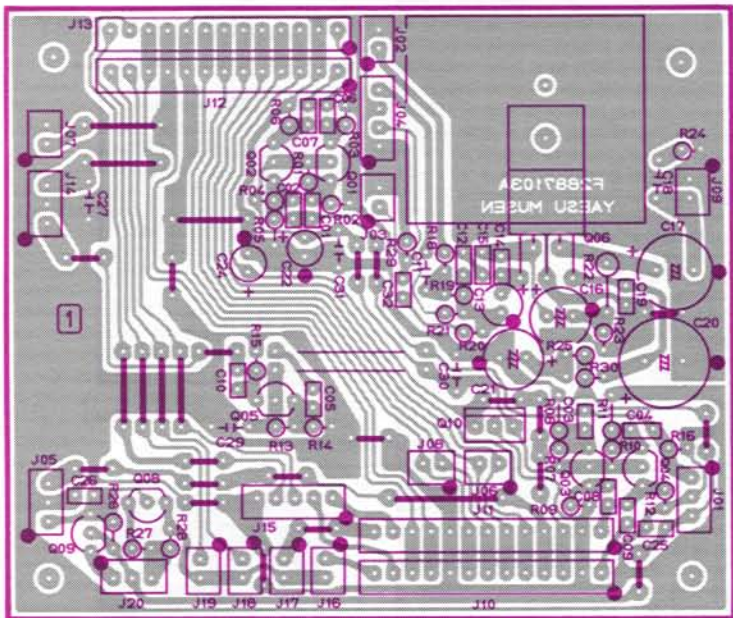

Component side (obverse)

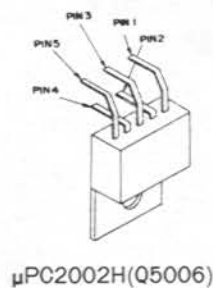

μPC2002H(Q5006)

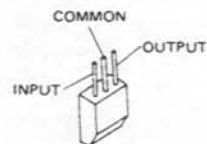

μPC78L08(Q5010)

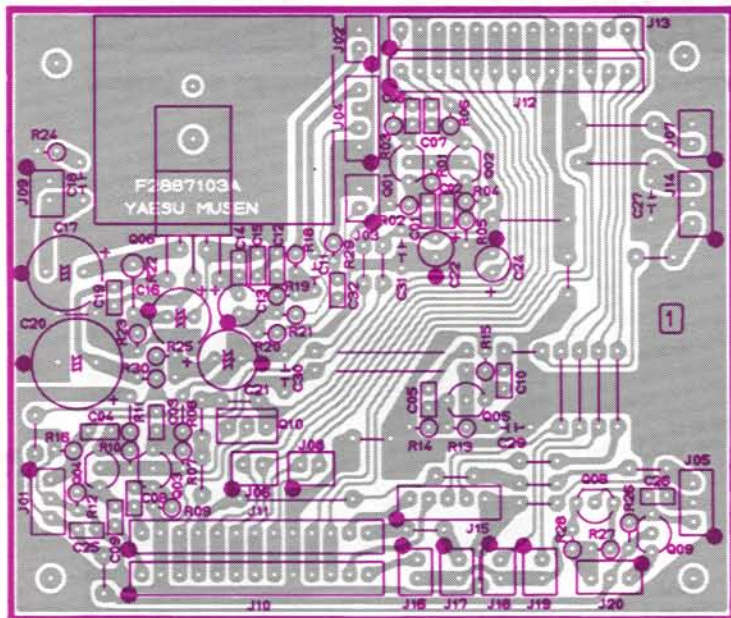

Component side (reverse)

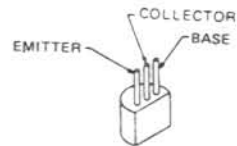

2SC458C(Q5008,5009)
2SC460B(Q5001-5005)

UNIT PARTS LAYOUT/CIRCUIT DIAGRAM

AF UNIT VOLTAGE CHART

(DC VOLTS)

	E(S)	C(D)	(G ₁) ^B	(G ₂)	REMARKS	E(S)	C(D)	(G ₁) ^B	(G ₂)	REMARKS
Q5001	3.4	8.0	4.1			Q5005	3.4	8.0	4.1	
Q5002	3.4	8.0	4.1			Q5008	0.01/1250	0.01/13.60	0.01/1250	PRE AMP OFF/ON
Q5003	3.4	8.0	4.1			Q5009	0.01/13.60	13.60	0.01/13.10	PRE AMP OFF/ON
Q5004	3.4	8.0	4.1							

AF UNIT IC VOLTAGE CHART

(DC VOLTS)

	1	2	3	4	5	REMARKS	1(IN)	2(GND)	3(OUT)	4	5	REMARKS
Q5006	0.7	0.7	0	6.4	13.6		Q5010	13.8	0	8.0		

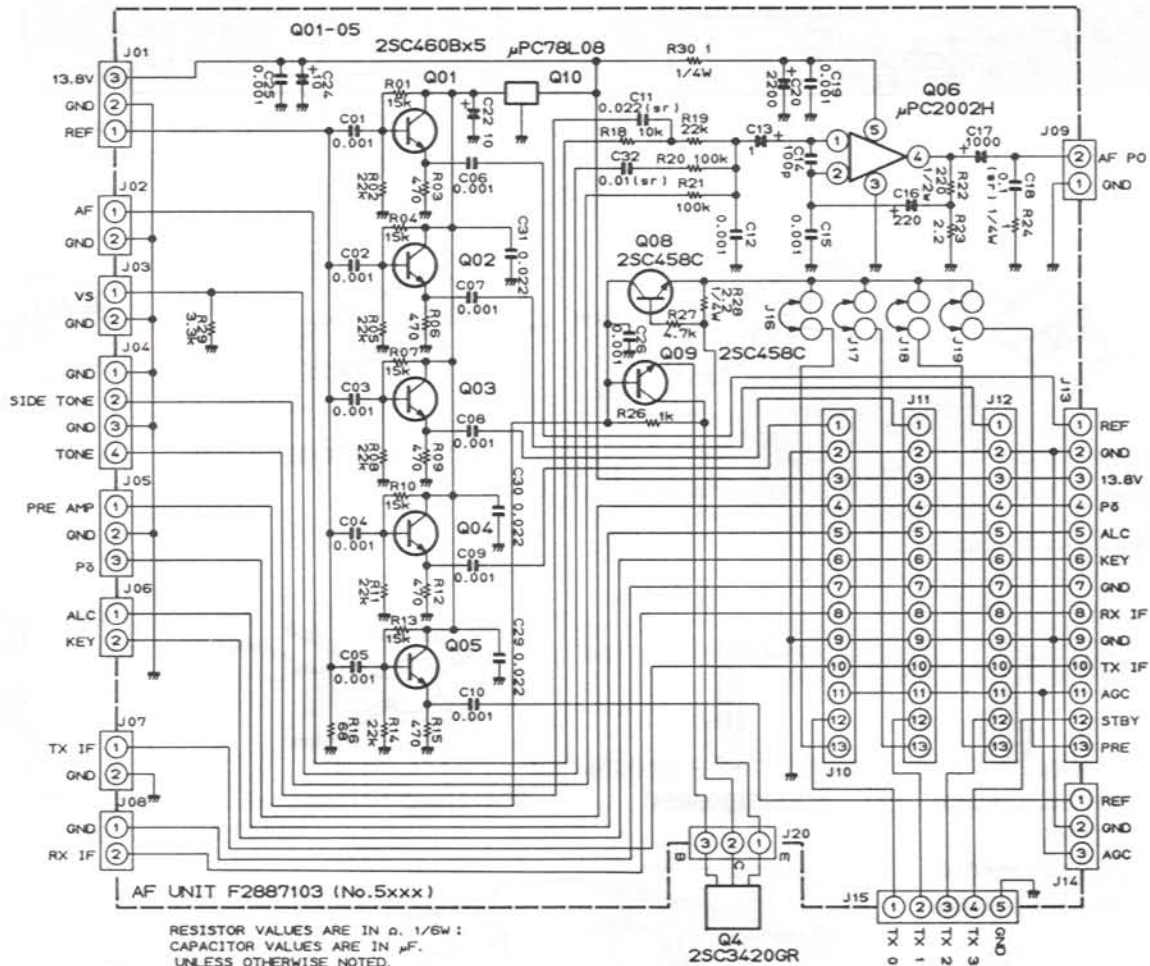

RESISTOR VALUES ARE IN Ω, 1/6W;
CAPACITOR VALUES ARE IN μF,
UNLESS OTHERWISE NOTED.
(sr) CAPACITORS ARE SEMICONDUCTOR CERAMIC, 25Vv;

4z
UNIT

144MHz MAIN UNIT PARTS LAYOUT

144MHz MAIN UNIT (No. 6XXX)

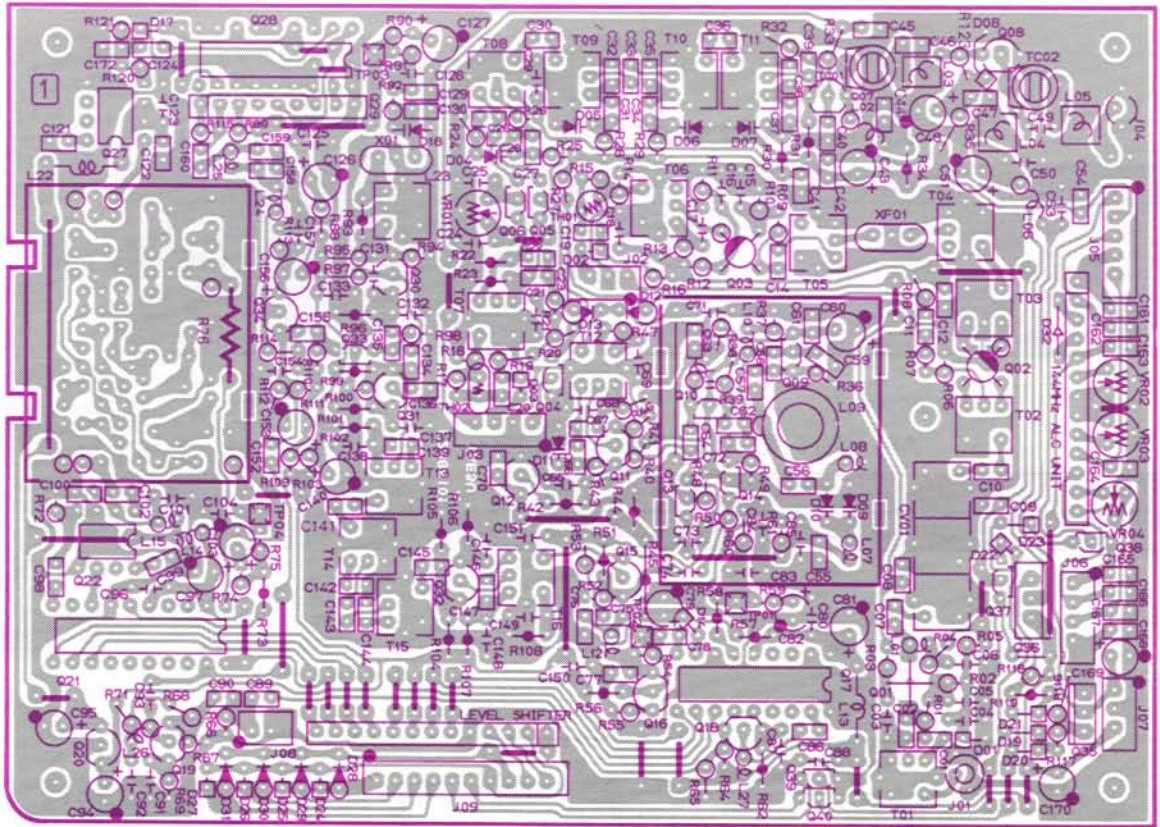

Component side (obverse)

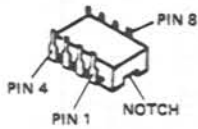

MB504(Q6022)
MB505-16(Q6027)

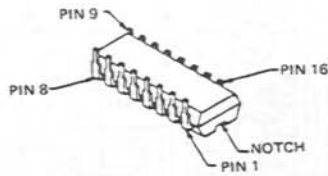

TC9122P(Q6028)
MC145155P(Q6017)

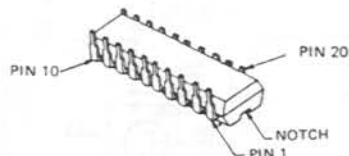

MC145156P(Q6021)

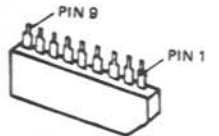

TC5081AP(Q6029)

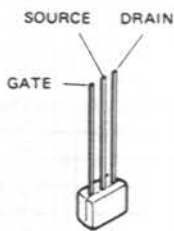

2SK192AGR(Q6009)
2SK241GR
(Q6005,6006,6010
6013,6014,6033)

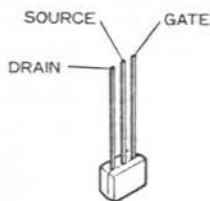

2SK507F(Q6024)

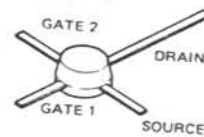

3SK122L(Q6001,6003)

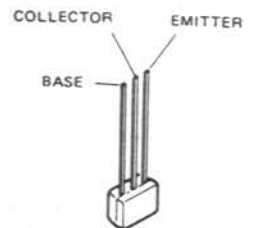

BA1A4P (Q6004,6039,6040)



2SB772Q(Q6035,6036)

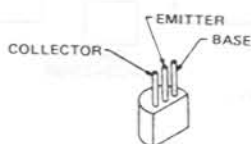

2SC3355(Q6025)

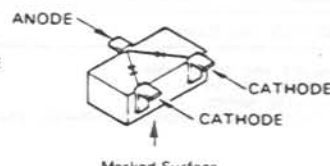

1SS181(A3) (Q9501,9502)

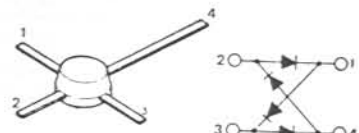

ND487C1-3R(Q6002)

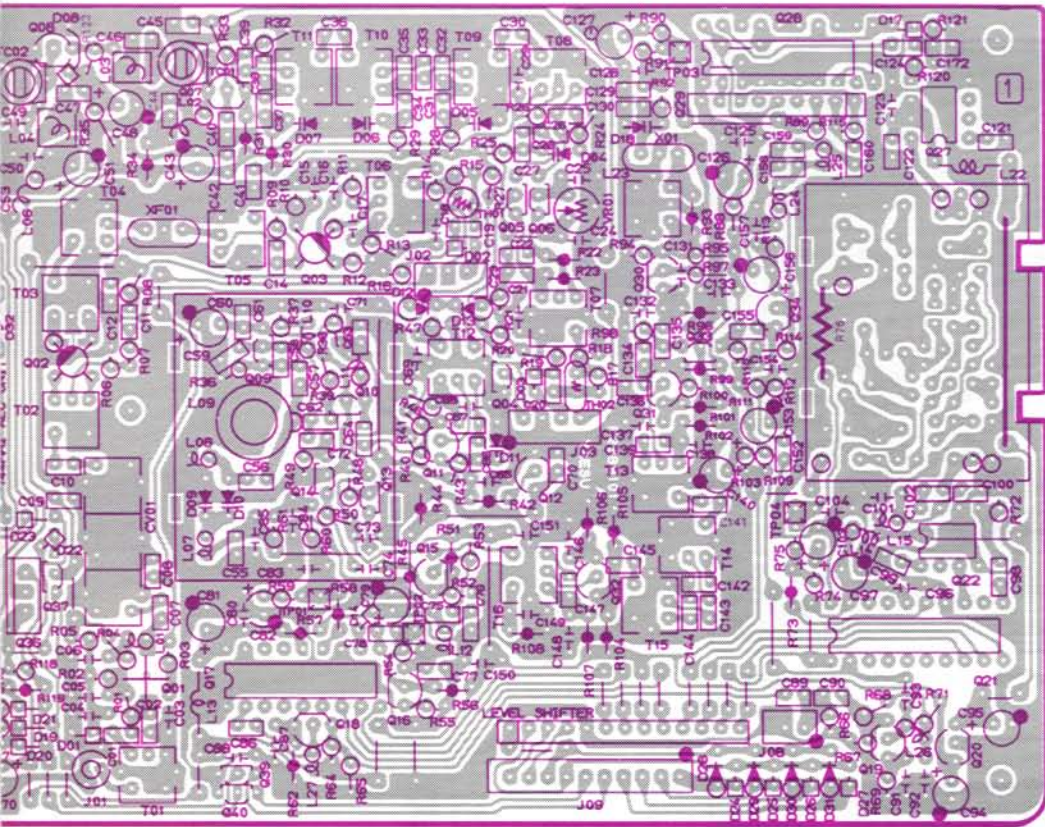

144MHz SUB VCO UNIT
(No. 6XX)

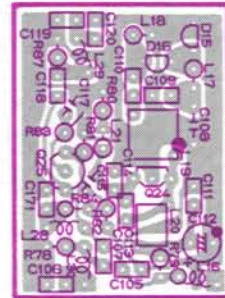

Component side (obverse)

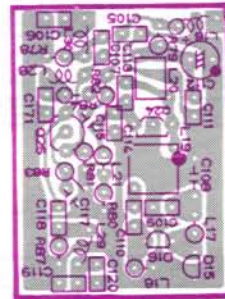

Component side (reverse)

Component side (reverse)

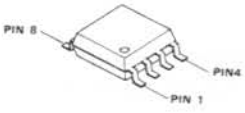
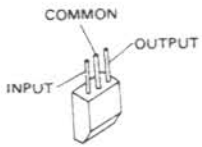

μPC78L05(Q6020)

μPC358G(Q9501)

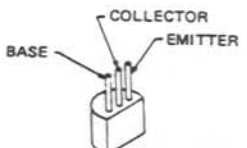
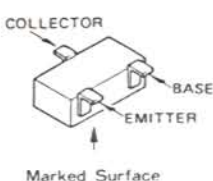

C2712GR(LG) (Q9101-9106)

2SA1528(Q6037,6038)
2SC458C
(Q6012,6018,6019)
2SC460B(Q6030,6034)
2SC535B
(Q6011,6015,6016)
(6031,6032)
2SC2026(Q6007)
2SC2053(Q6008)

144MHz SUB VCO UNIT

144MHz SHIFT UNIT

144MHz ALC UNIT

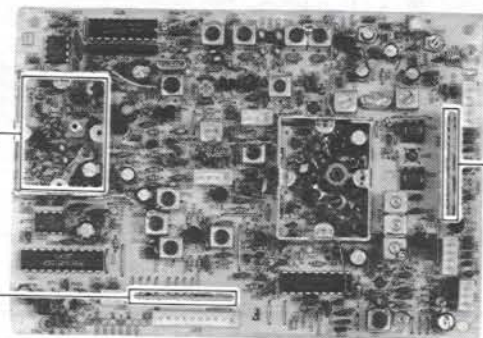

144MHz SHIFT UNIT
(No. 91XX)

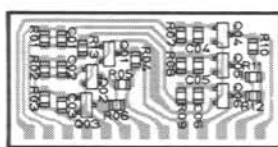

① ④ ⑦ ⑩ ⑬
Solder side (obverse)

144MHz ALC UNIT
(No. 95XX)

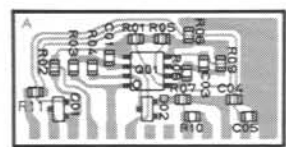

① ④ ⑦ ⑩ ⑬
Solder side (obverse)

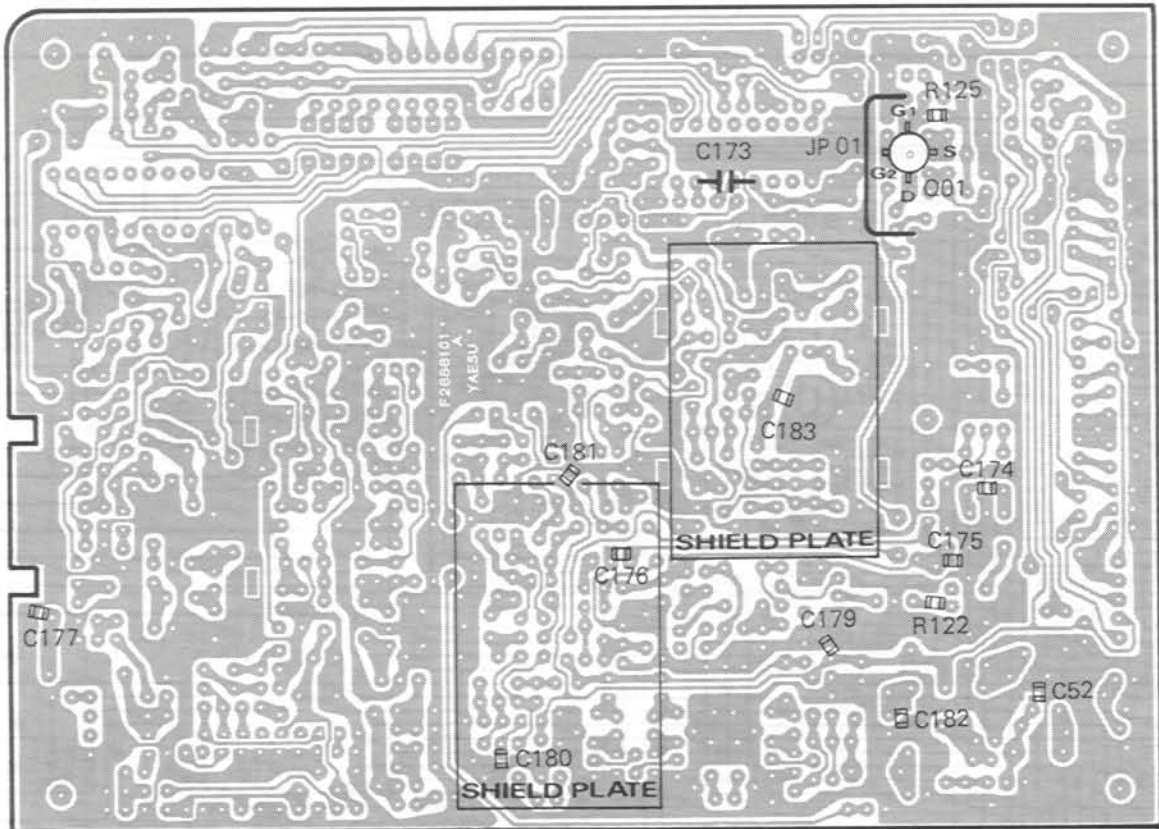

Solder side (obverse)

144MHz MAIN UNIT VOLTAGE CHART

(DC VOLTS)

	E(S)	C(D)	(G ₁) ^B	(G ₂)	REMARKS		E(S)	C(D)	(G ₁) ^B	(G ₂)	REMARKS
Q6001	1.03	8.70	0.93	2.04	RX	Q6018	0.2	9.0	2.3		
Q6003	0.6	8.4	0.6	4.5	RX	Q6019	1.5	8.8	2.1		
Q6004	0/9.0	0/0	0/0.01		RX / TX	Q6024	1.3	8.9	0		
Q6005	1.0	8.6	0		TX	Q6025	1.3	7.8	2.0		
Q6006	1.0	8.6	0		TX	Q6030	2.3	7.9	2.9		
Q6007	1.0	8.9	2.5		TX	Q6031	0.9	7.8	1.5		
Q6008	0	13.5	0.7		TX	Q6032	8.70	1.96	1.20		
Q6009	0.66	8.50	0			Q6033	0	4.1	0		
Q6010	0	9.0	0			Q6034	0.9	4.9	1.5		
Q6011	1.45	8.70	1.65			Q6035	13.7	13.8	12.9		
Q6012	0	0.07	0.71			Q6036	9.00	0/9.00	9.05/8.32		RX / TX
Q6013	3.3	9.0	2.6			Q6037	9.00	9.00/0	0.76/9.00		RX / TX
Q6014	0	4.9	0			Q6038	0/12.60	0/12.60	0.01/0.82		PRE AMP OFF/ON
Q6015	1.10	5.80	1.73			Q6039	0	0.13/8.80	4.90/0		RX / TX
Q6016	1.40	5.20	1.14			Q6040	0	8.85/0.22	0/4.90		RX / TX

144MHz PA UNIT IC VOLTAGE CHART (DC VOLTS)

	1	2	3	4	5	REMARKS
Q6501	—	13.80	9.00	13.34	—	@ 10W output

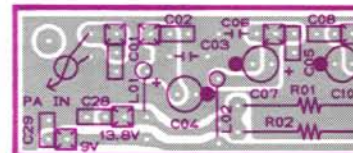

144MHz MAIN UNIT PARTS LAYOUT

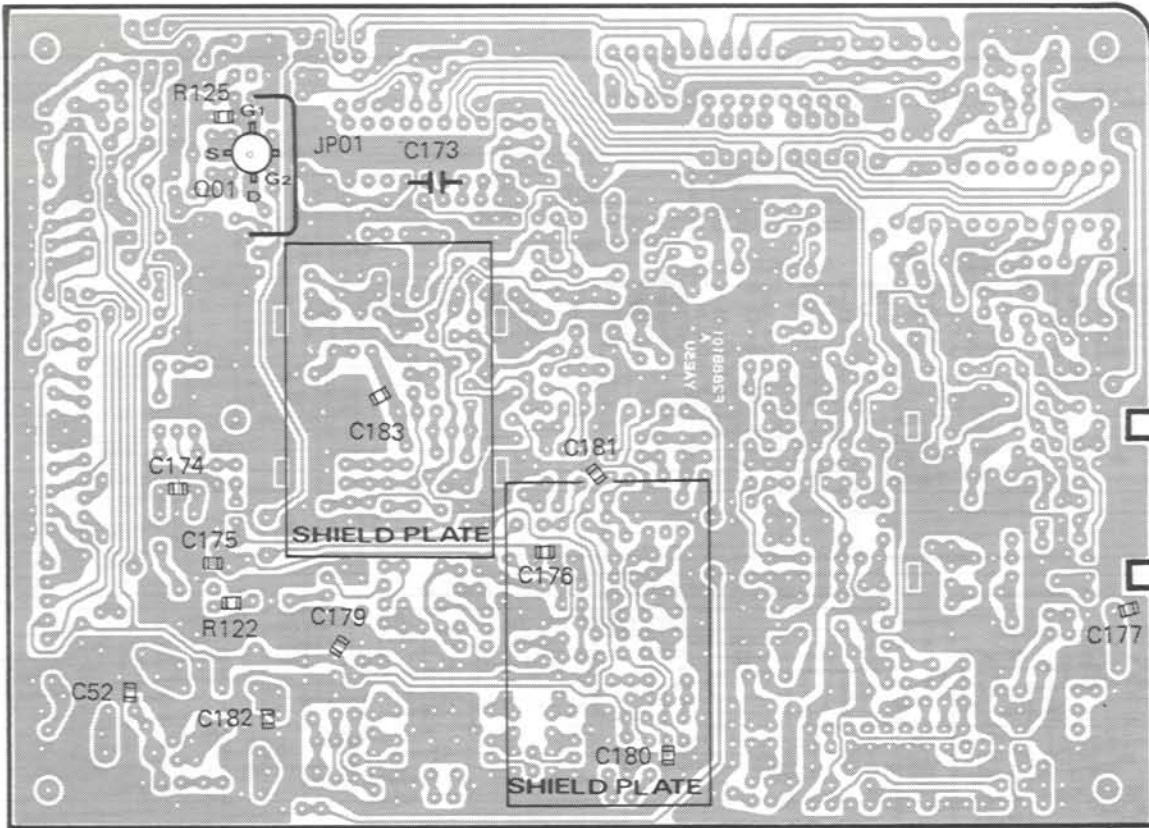

Solder side (reverse)

144MHz MAIN UNIT IC VOLTAGE CHART

(DC VOLTS)

	1(IN)	2(GND)	3(OUT)	4	5	6	7	8	9	10	11	12	13	14	15	16	17	18	19	20	REMARKS
Q6002	0	0	0																		RX
Q6017	8.80	0	—	—	8.80	2.70	0	8.80	0.07	0.075	0.07	0.05	—	—	—	—	3.50	0			
Q6020	8.8	0	5.0																		
Q6021	0	4.90	—	—	4.90	0.97	0	4.30	—	2.00	0.06	0.05	0.06	—	—	—	2.60	—	2.06	4.90	
Q6022	2.60	5.00	—	2.96	0	4.30	—	2.60													
Q6027	2.5	5.0	5.0	2.7	0	2.5															
Q6028	7.50	3.10	0	7.50	0	0	7.50	0	0	0	0	0	0	0	0	0	0.34	0			
Q6029	3.40	3.30	2.80	—	7.50	—	3.40	0.34	0												

144MHz PA UNIT (No. 65XX)

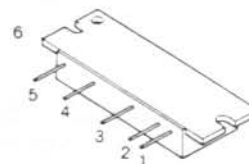

1. INPUT
2. Vcc₁
3. Vcc₂
4. Vcc₃
5. OUTPUT
6. FLA

M57713(10W) (Q6501)
M57727(25W)

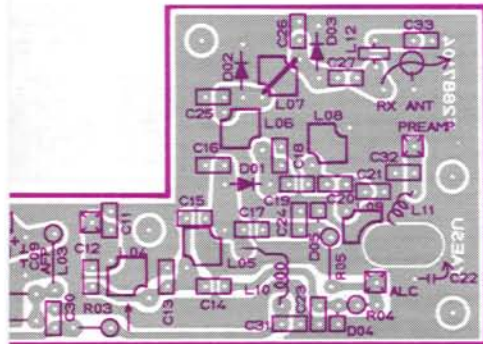

Component side (obverse)

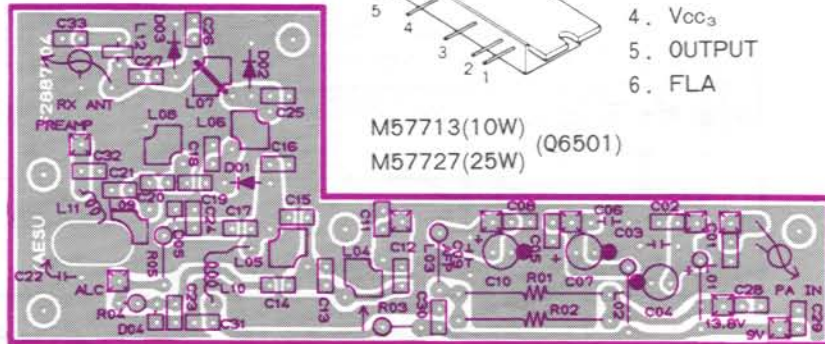

Component side (reverse)

144MHz MAIN UNIT CIRCUIT DIAGRAM

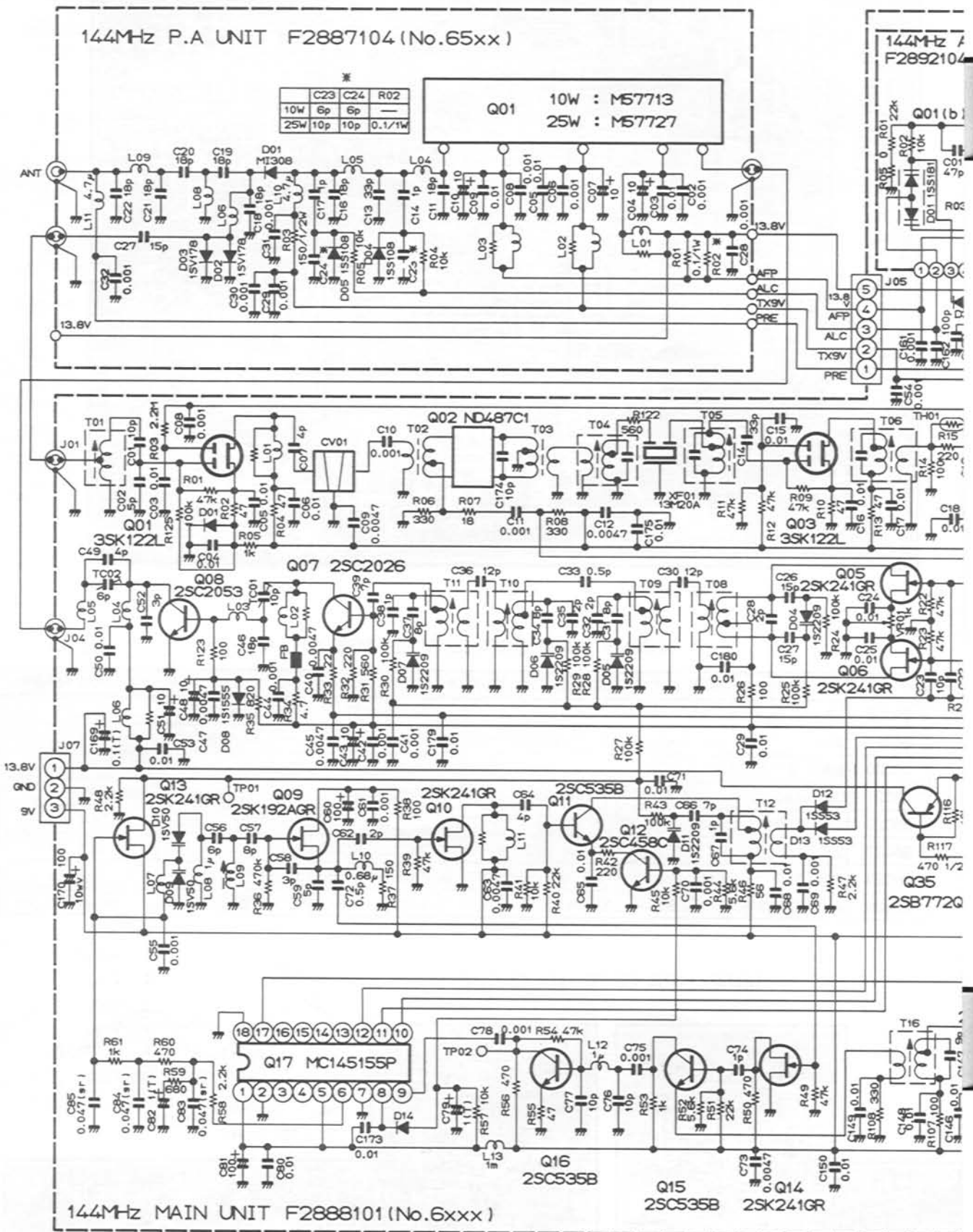

RESISTOR VALUES ARE IN Ω , 1/6W:
CAPACITOR VALUES ARE IN μ F.
INDUCTOR VALUES ARE IN HENRIES.
UNLESS OTHERWISE NOTED.

DIODES ARE TYPE 1SS270 UNLESS OTHERWISE NOTED.
(T)CAPACITORS ARE TANTALUM.
(μ r)CAPACITORS ARE SEMICONDUCTOR CERAMIC. 25Vv:

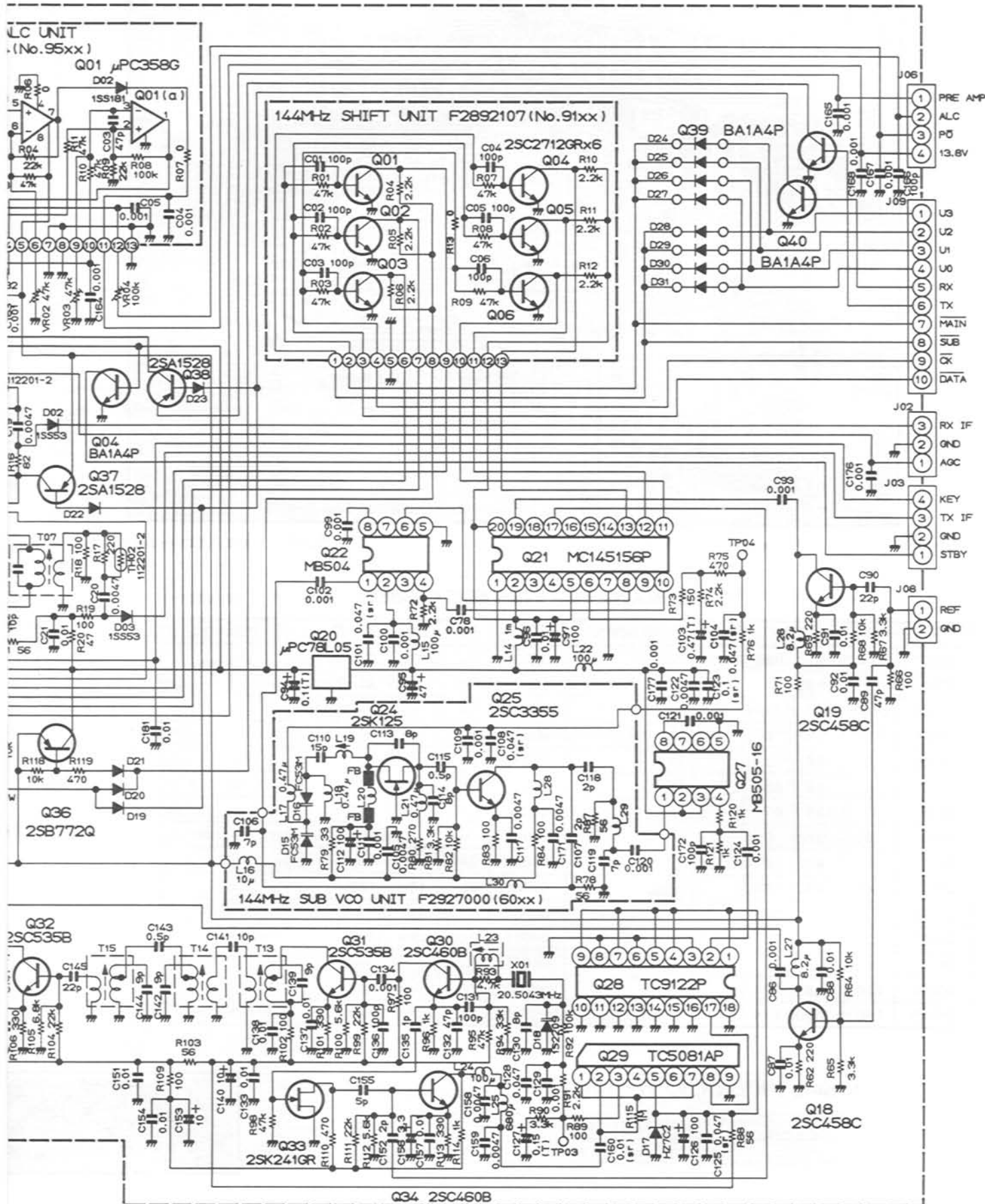

430MHz RF UNIT (No. 7×××)

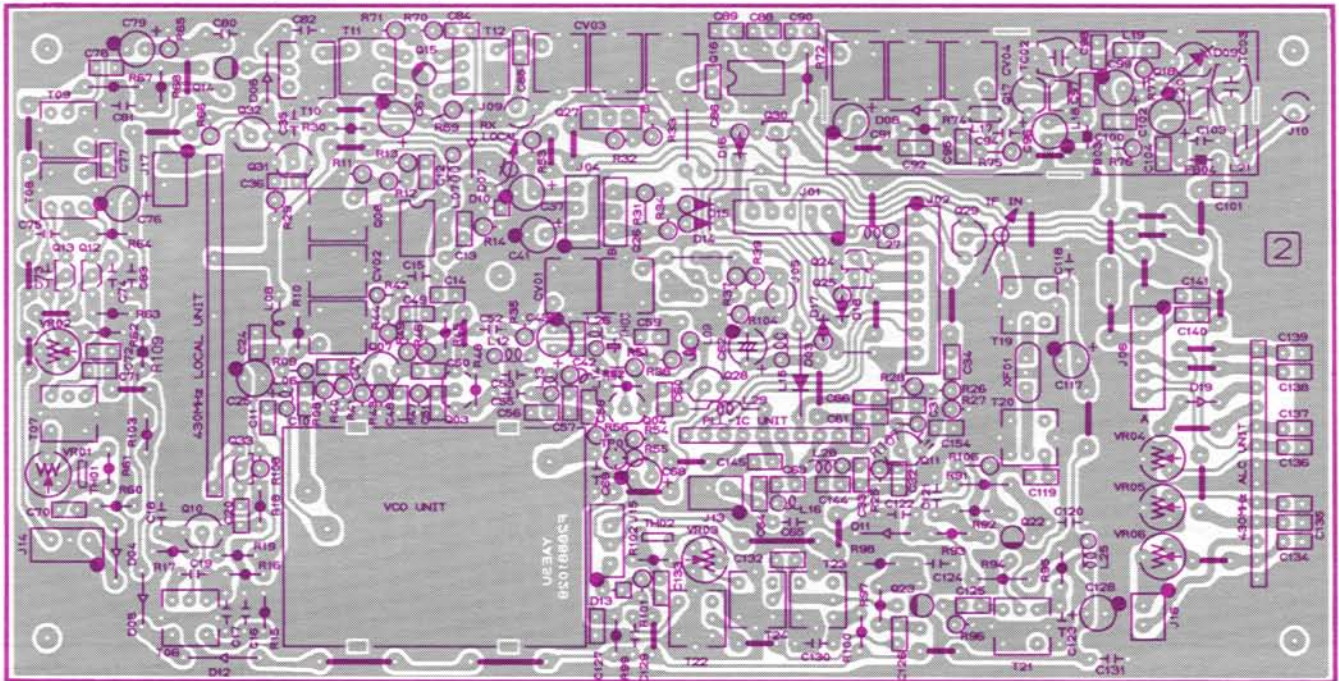

Component side (obverse)

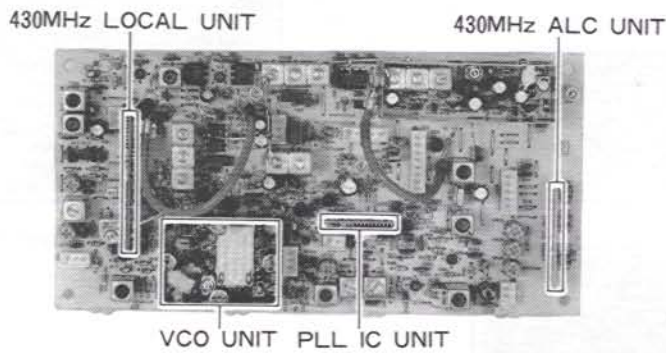

PLL IC UNIT
(No. 76××)

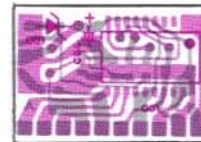

Mixed component side (obverse)

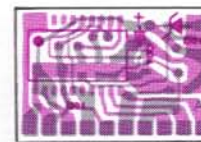

Mixed component side (reverse)

430MHz ALC UNIT
(No. 96××)

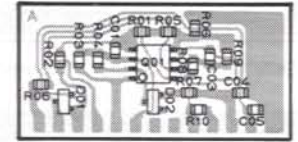

Solder side (obverse)

VCO UNIT (No. 74××)

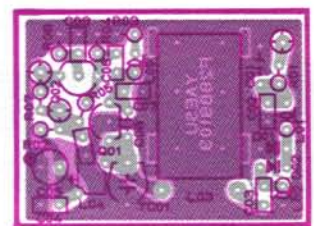

Component side (obverse)

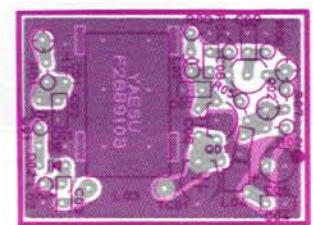

Component side (reverse)

430MHz LOCAL UNIT (No. 77××)



Mixed component side (obverse)



Chip only side (obverse)

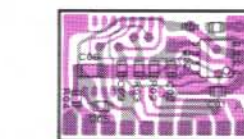

Chip only side (obverse)



Mixed component side (reverse)



Chip only side (reverse)

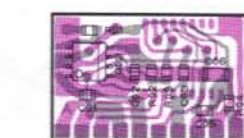

Chip only side (reverse)

430MHz RF UNIT PARTS LAYOUT

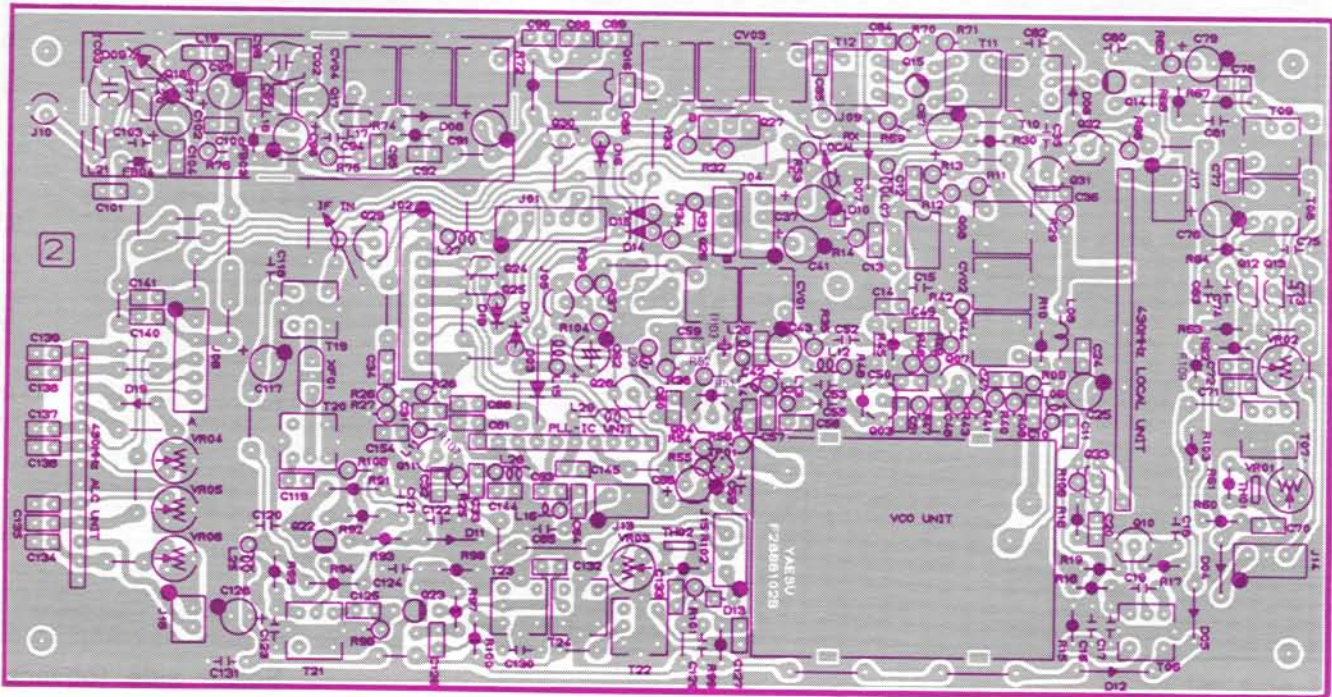

Component side (reverse)

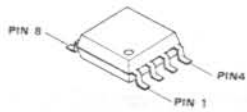

μ PC358G(Q9601)
MB503(Q7602,7703)

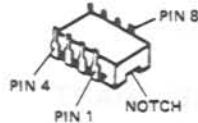

μ PC1656C(Q7008,7016)

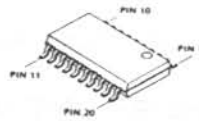

JLC1007(Q7601)

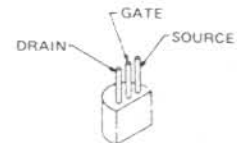

2SK125(Q7401)

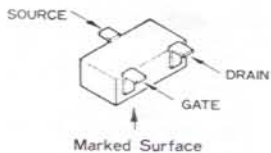

2SK210GR(YG) (Q7701)
2SK302GR(TG) (Q7702)

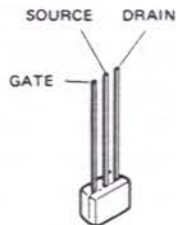

2SK241GR
(Q7012,7013,7033)

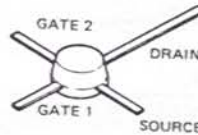

3SK81(Q7023)
3SK122L(Q7014,7022)

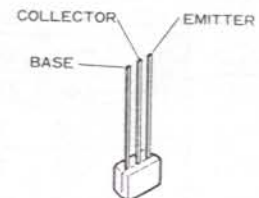

BA1A4P
(Q7024,7025,7030)
7034

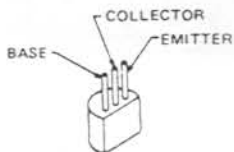

2SA1528(Q7028,7029)
2SC458C
(Q7011,7031,7032)
2SC460B(Q7010)

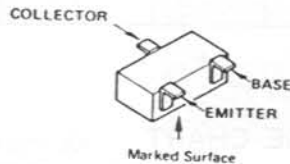

2SC2712GR(LG) (Q7705)

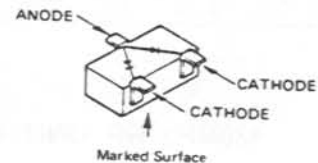

1SS181(A3) (Q9601,9602)



2SB772Q(Q7026,7027)

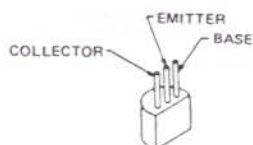

2SC2407(1) (Q7018)
2SC3355
(Q7003,7004,7007)
7017,7402

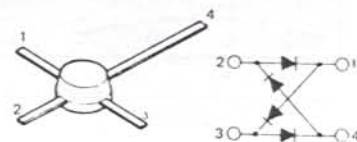

ND487C2-3R(Q7015)

430MHz RF UNIT PARTS LAYOUT

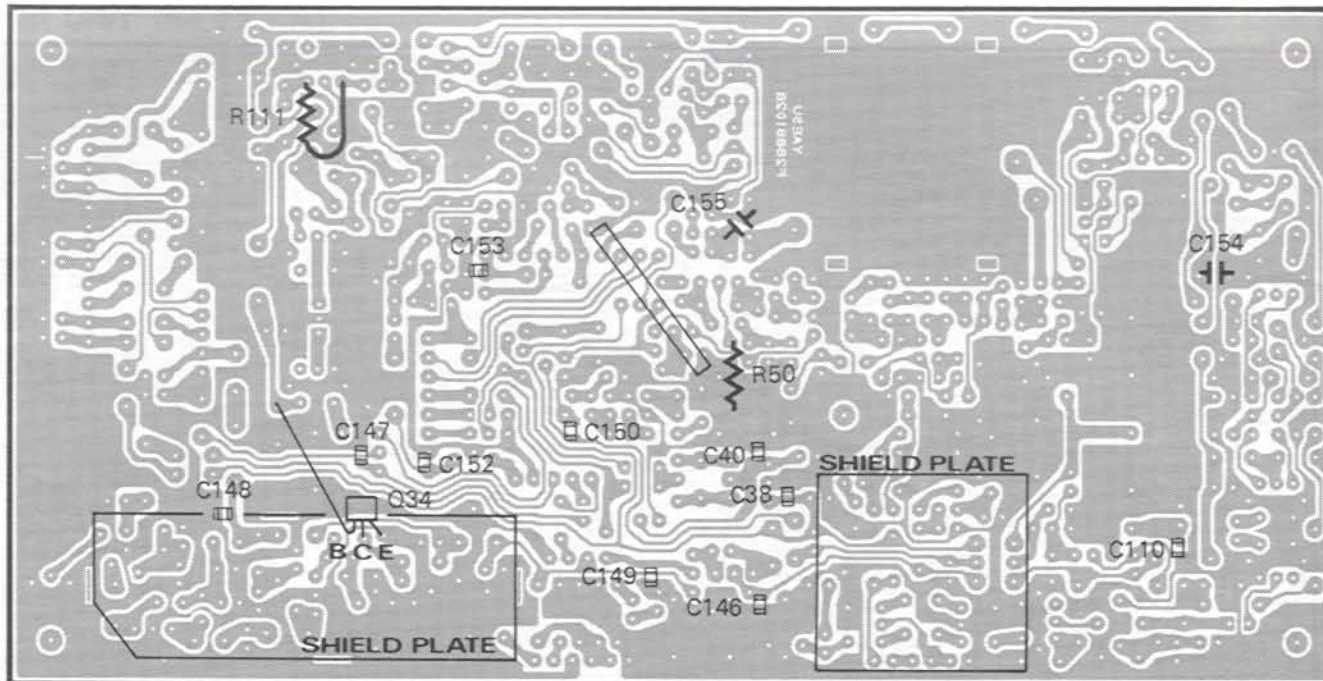

Solder side (obverse)

430MHz RF UNIT VOLTAGE CHART

(DC VOLTS)

	E(S)	O(D)	(G ₁) ^B	(G ₂)	REMARKS		E(S)	O(D)	(G ₁) ^B	(G ₂)	REMARKS
Q7003	1.50	4.40	2.15			Q7024	0	0.15/8.75	4.90/0		RX / TX
Q7004	0.5	5.6	1.3			Q7025	0	8.80/0.35	0/4.85		RX / TX
Q7007	1.27	5.53	2.02			Q7026	13.8	13.8/13.6	12.8/12.7		RX / TX
Q7010	0.9	8.1	1.6			Q7027	9.0	0/9.0	9.0/8.3		RX / TX
Q7011	1.20	5.90	1.85			Q7028	9.0	9.0/0	0.8/9.0		RX / TX
Q7012	0.80	8.75	0	0.80		Q7029	0/12.60	0/12.60	0.01/0.82		PRE AMP OFF/ON
Q7013	0.80	8.75	0	0.80		Q7030	0	0.25/0.03	0/9.00		RX / TX
Q7014	2.65	8.20	2.70	5.20		Q7031	0	0.037	0.65		
Q7017	0	9.00	0.75			Q7032	0	0	0.037		
Q7018	0	13.20	0.65			Q7033	0	7.3	0		
Q7022	1.03	8.57	0.92	2.03		Q7034	0/0.79	0	8.95/0		RX / TX
Q7023	0.70	8.70	0	0.89							

430MHz RF UNIT IC VOLTAGE CHART

(DC VOLTS)

	1(IN)	2(OUT)	3	4	5	6	7	8	REMARKS
Q7008	0.97	0	0	0	4.80	9.00	9.00	0	
Q7015	0	0							
Q7016	0.98	0	0	0	4.78	8.80	8.80	0	

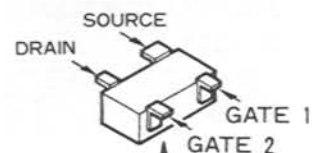

Marked surface

3SK164(F0) (Q7801,7802)

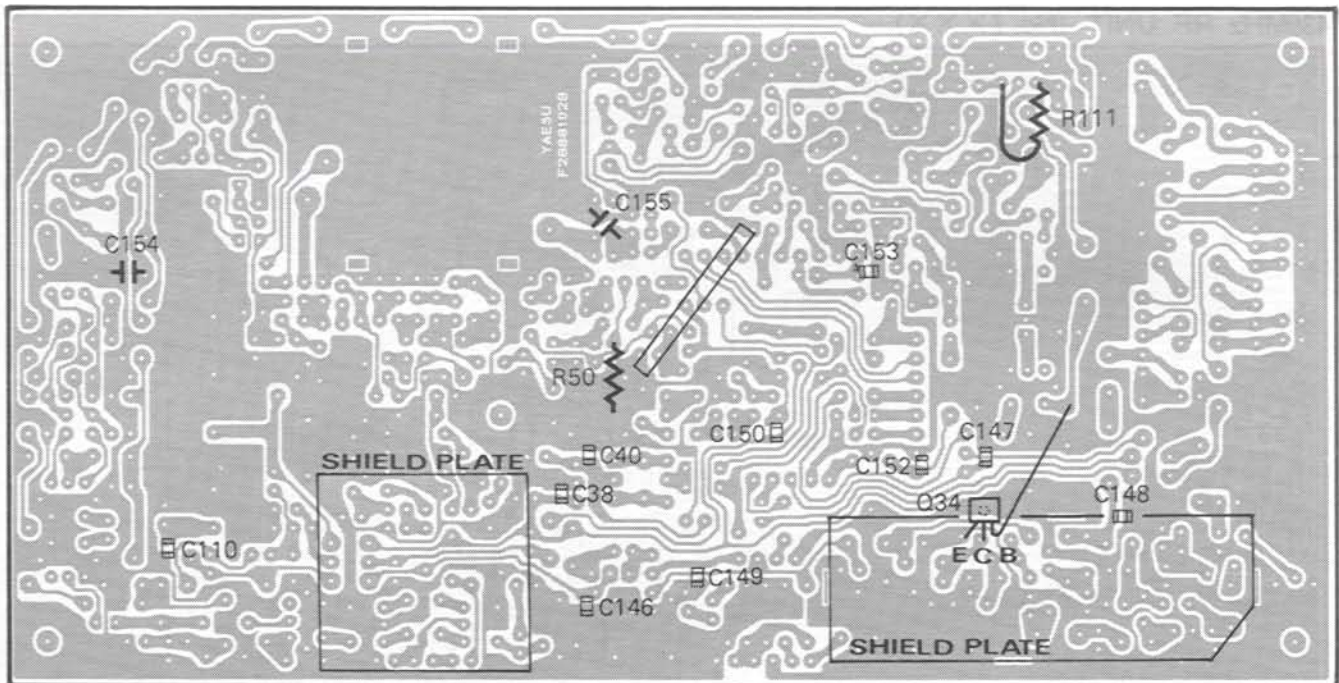

Solder side (reverse)

430MHz FRONTEND UNIT
(No. 78XX)

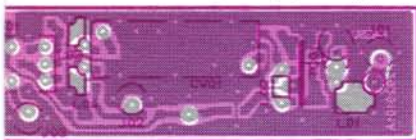

Component side (obverse)

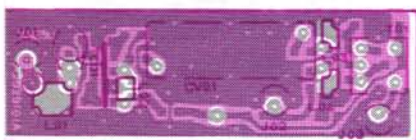

Component side (reverse)

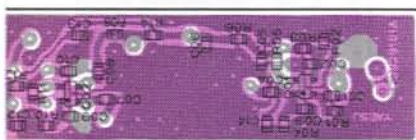

Chip side (obverse)

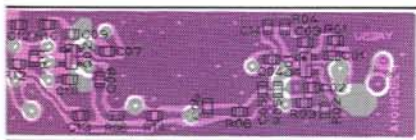

Chip side (reverse)

430MHz PA UNIT (No. 75XX)

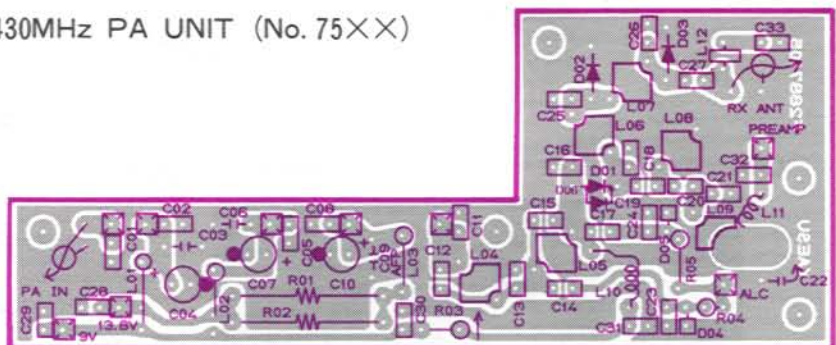

Component side (obverse)

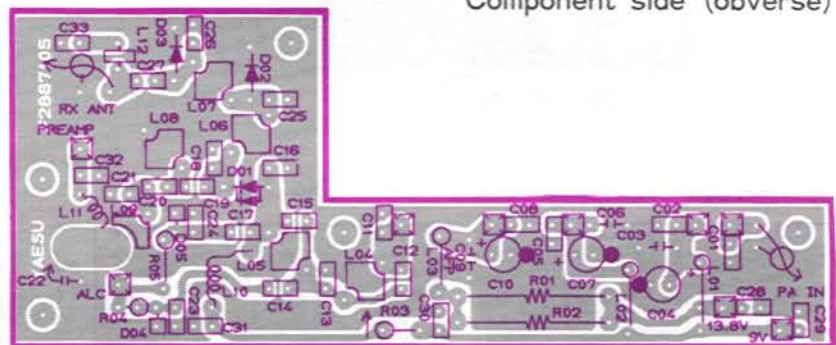

Component side (reverse)

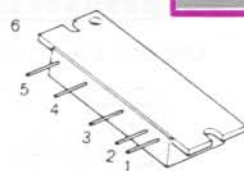

430MHz PA UNIT IC VOLTAGE CHART

(DC VOLTS)

	1	2	3	4	5	REMARKS
Q7501	—	9.0	13.8	13.3	—	@ 10W output

1. INPUT 2. Vcc₁ 3. Vcc₂
4. Vcc₃ 5. OUTPUT 6. FLA
M57716(10W)
M57745(25W) (Q7501)

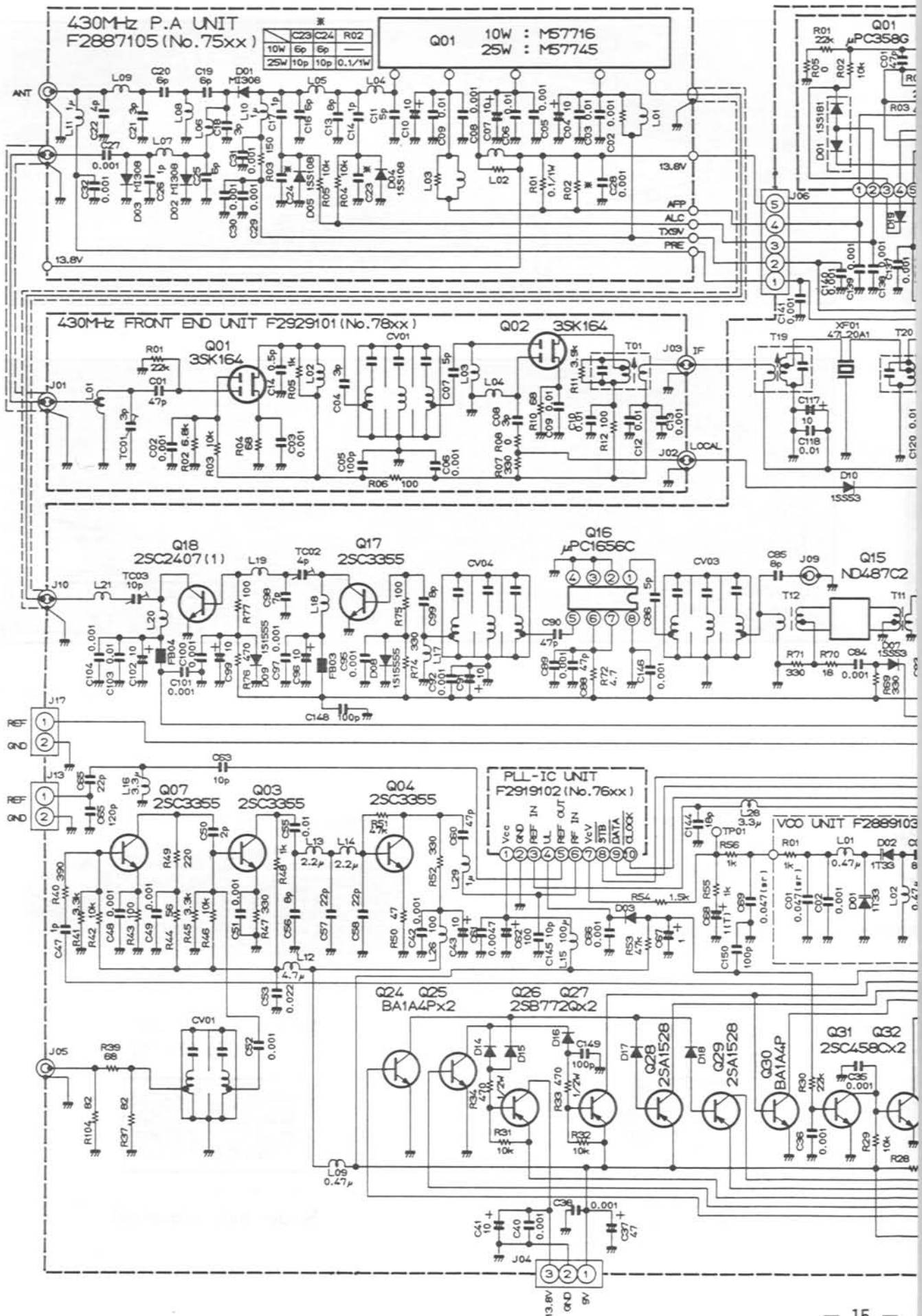

430MHz RF UNIT CIRCUIT DIAGRAM

430MHz RF UNIT

F2888102 (No. 7xxx)

RESISTOR VALUES ARE IN Ω , 1/10W;
CAPACITOR VALUES ARE IN μ F.
INDUCTOR VALUES ARE IN HENRIES;

(T) CAPACITORS ARE TANTALUM.
DIODES ARE TYPE 1SS270 UNLESS OTHERWISE NOTED.

※ 430MHz LOCAL UNIT : See page 17.

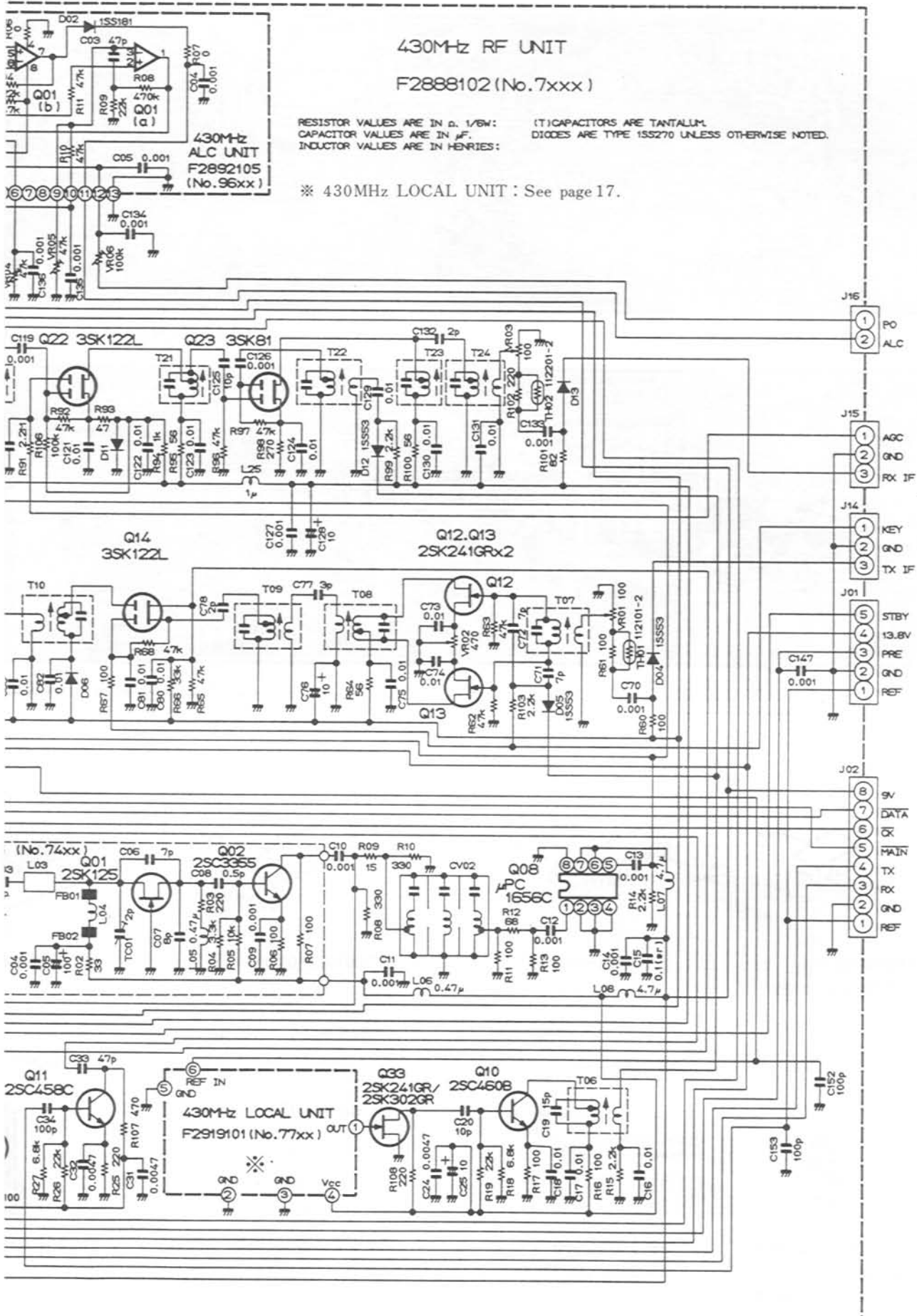

430MHz PLL UNIT PARTS LAYOUT

430MHz PLL UNIT (No. 8XXX)

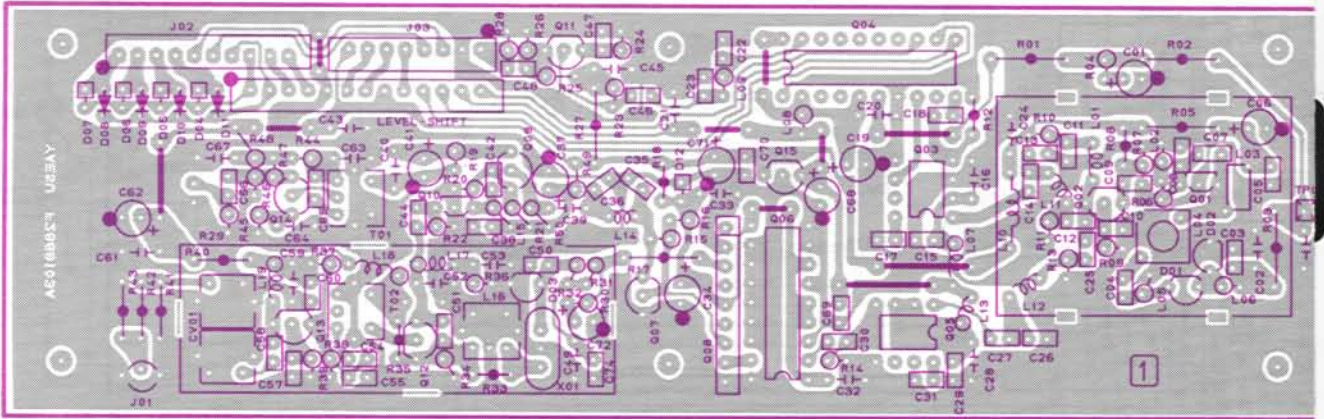

Component side (obverse)

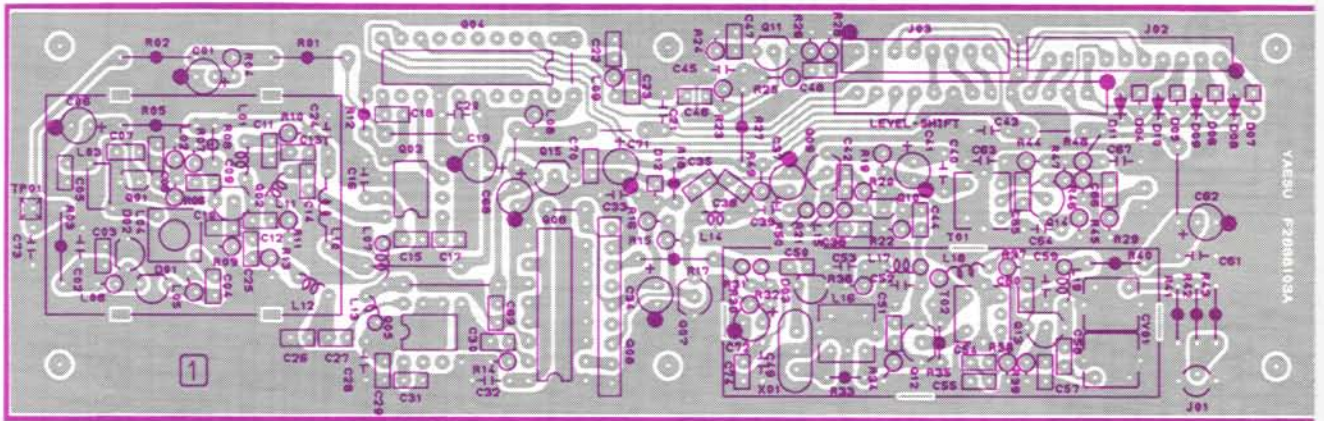

Component side (reverse)

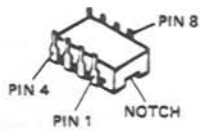

MB504(Q8003)
MB505-16(Q8005)

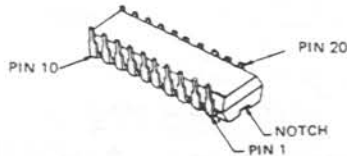

MC145156P(Q8004)

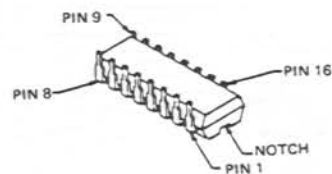

TC9122P(Q8006)



TC5081A

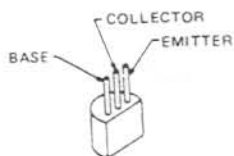

2SC458C(Q8007,8011)
2SC535B
(Q8009,8012,8014)

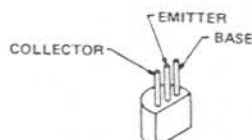

2SC2407A(Q8013)
2SC3355(Q8002)

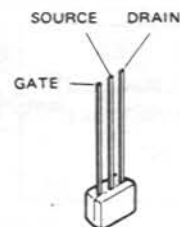

2SK241GR(Q8010)

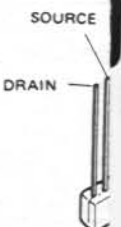

2SK507F

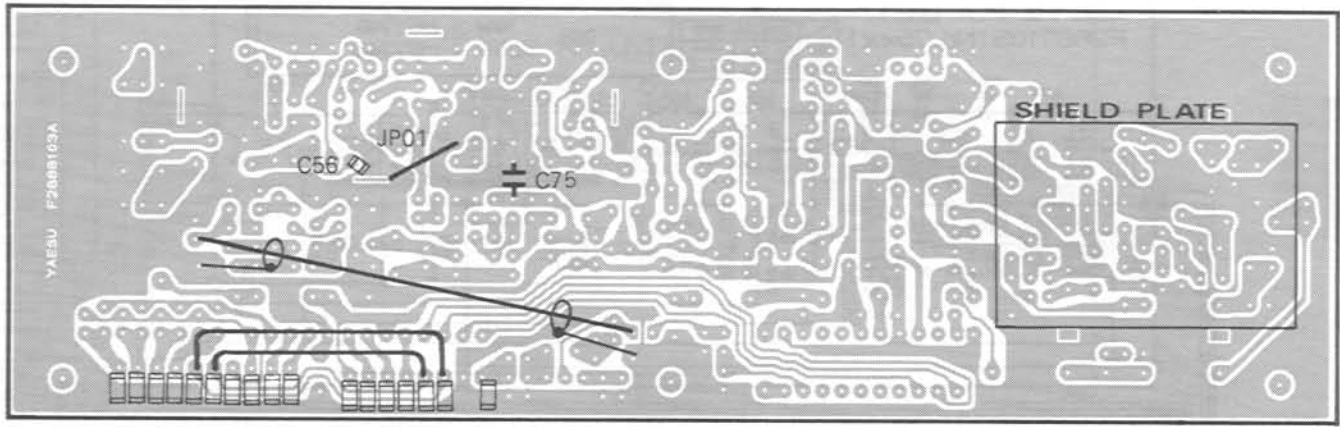

C92
C91
C90
C89
C88
C87
C86
C85
C84
C83

C82
C81
C80
C79
C78
C77
C76

Solder side (obverse)

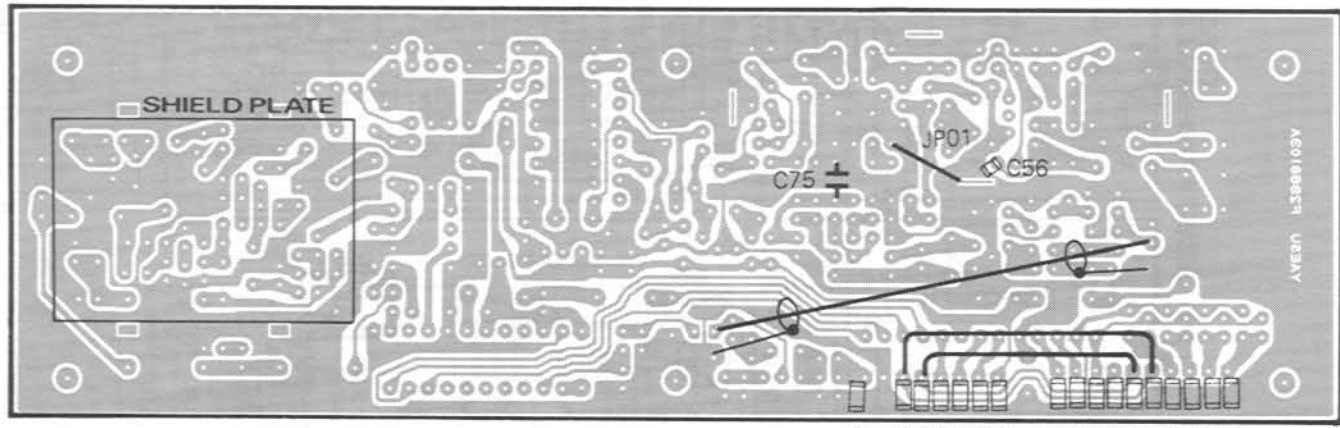

C92
C91
C90
C89
C88
C87
C86
C85
C84
C83

C82
C81
C80
C79
C78
C77
C76

Solder side (reverse)



P(Q8008)

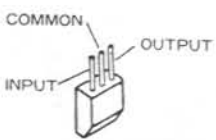

μPC78L05(Q8015)

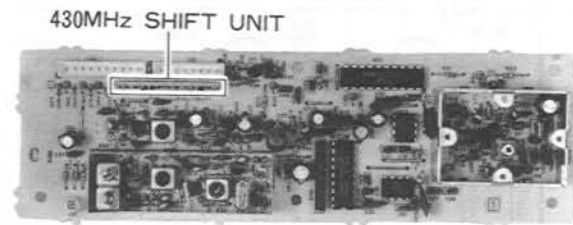

(Q8001)

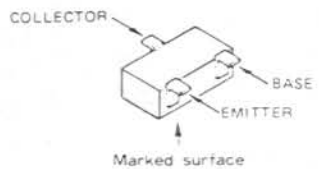

2SC2712GR(LG)
(Q9201-9206)

430MHz SHIFTER UNIT
(No. 92XX)

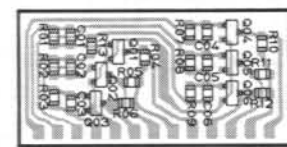

① ④ ⑦ ⑩ ⑬
Solder side (obverse)

430MHz PLL UNIT VOLTAGE CHART

(DC VOLTS)

	E(S)	C(D)	(G ₁) ^B	(G ₂)	REMARKS		E(S)	C(D)	(G ₁) ^B	(G ₂)	REMARKS
Q8001	0.96	8.90	0			Q8011	1.4	7.5	2.0		
Q8002	1.2	7.7	2.0			Q8012	3.0	8.7	3.6		
Q8007	0	4.40	0.55			Q8013	0.86	8.65	1.50		
Q8009	4.75	1.00	1.70			Q8014	1.2	8.6	1.9		
Q8010	0	7.80	0.01								

430MHz PLL UNIT IC VOLTAGE CHART

(DC VOLTS)

	1(IN)	2(GND)	3(OUT)	4	5	6	7	8	9	10	11	12	13	14	15	16	17	18	19	20	REMARKS	
Q8003	2.5	5.1	—	2.9	0	4.6	—	2.6														
Q8004	0	5.10	—	—	5.10	5.10	0	4.45	—	2.10	0.06	0.06	0.06	—	—	—	—	—	2.25	5.10		
Q8005	2.57	5.10	5.10	2.73	0	—	—	2.52														
Q8006	7.5	2.9	—	7.5	7.5	—	7.5	—	—	7.5	—	—	—	—	—	—	0.4	0				
Q8008	—	0	7.5	—	7.5	—	4.4	0.4	0													
Q8015	9.0	0	5.0																			

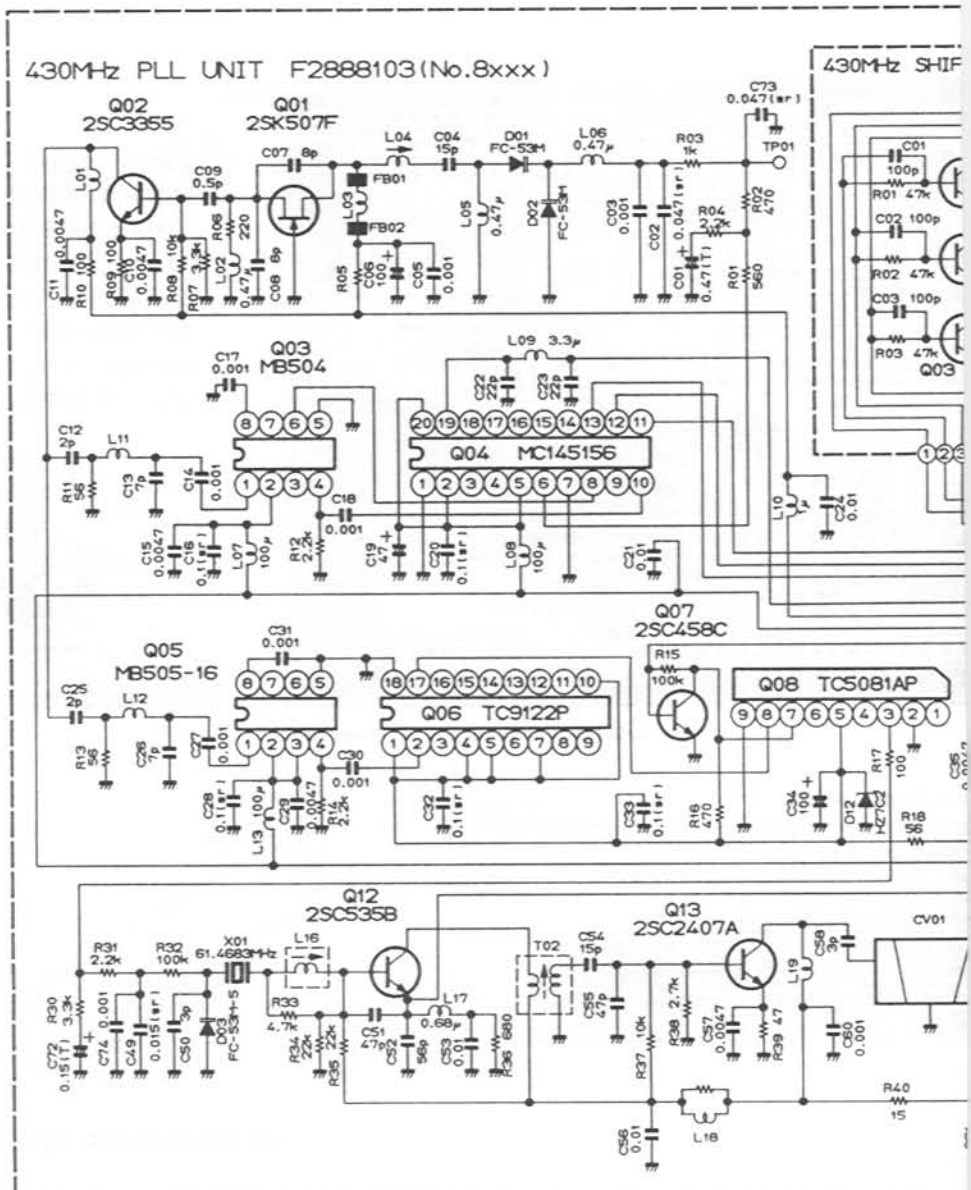

430MHz PLL UNIT CIRCUIT DIAGRAM

430MHz LOCAL UNIT F2919101 (No.77xx)

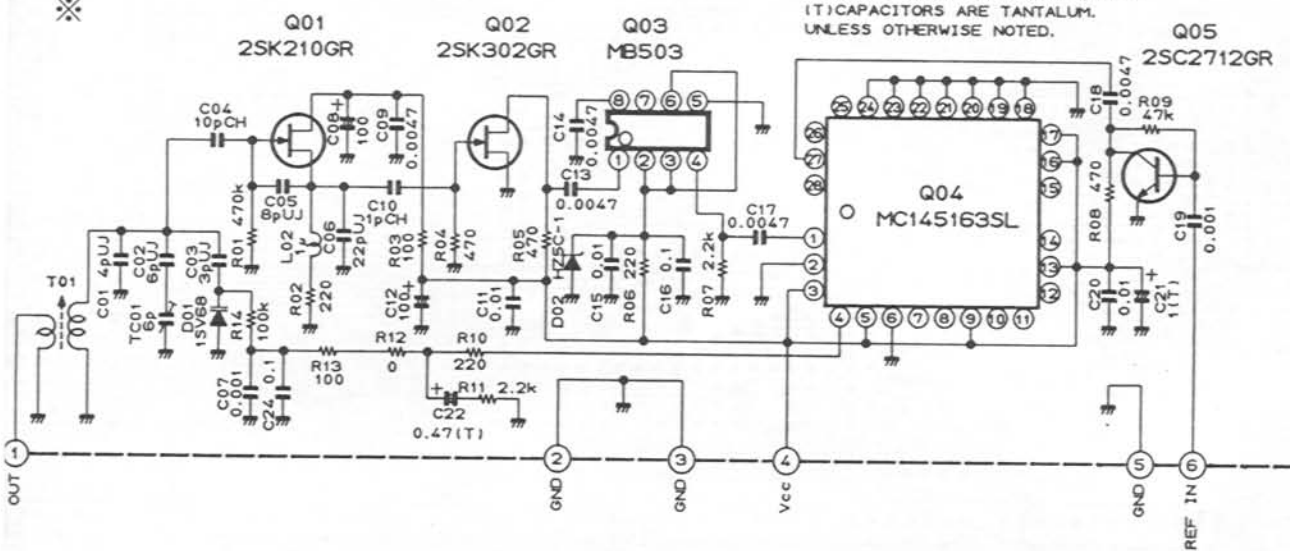

※ 430MHz LOCAL UNIT Parts Layout :
See page 13.

T UNIT F2892108 (No.92xx)

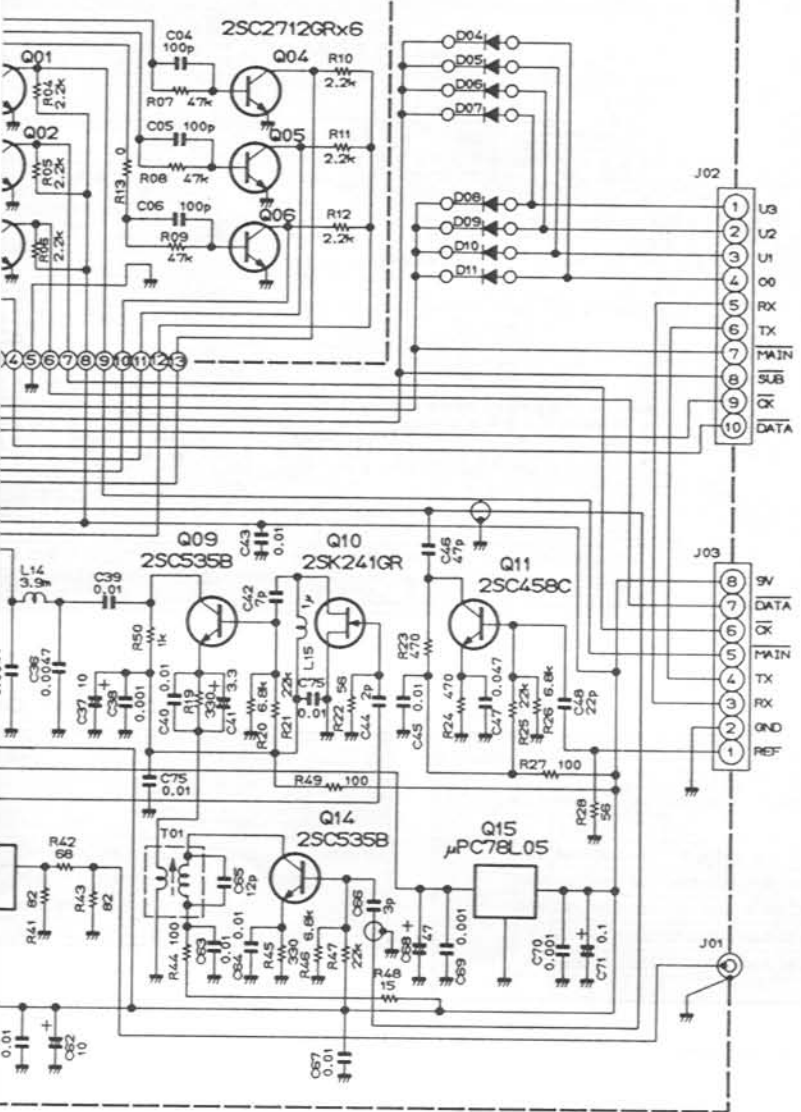

CNTL UNIT PARTS LAYOUT

CNTL UNIT (No. 1XXX)

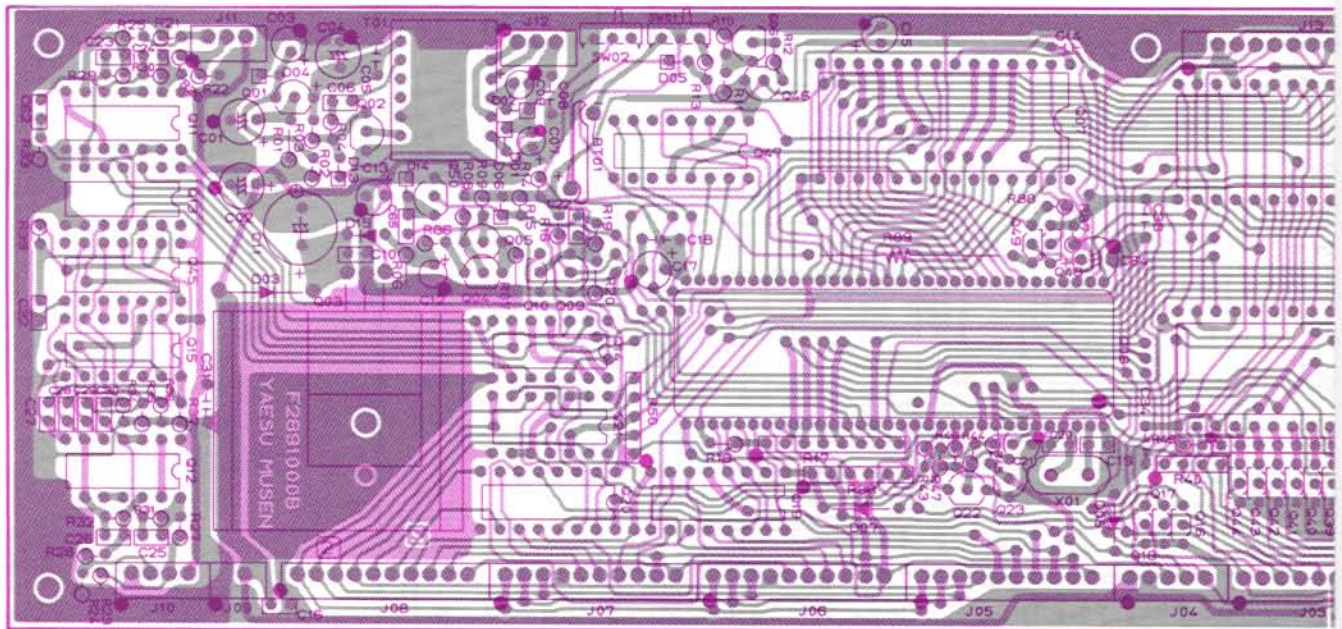
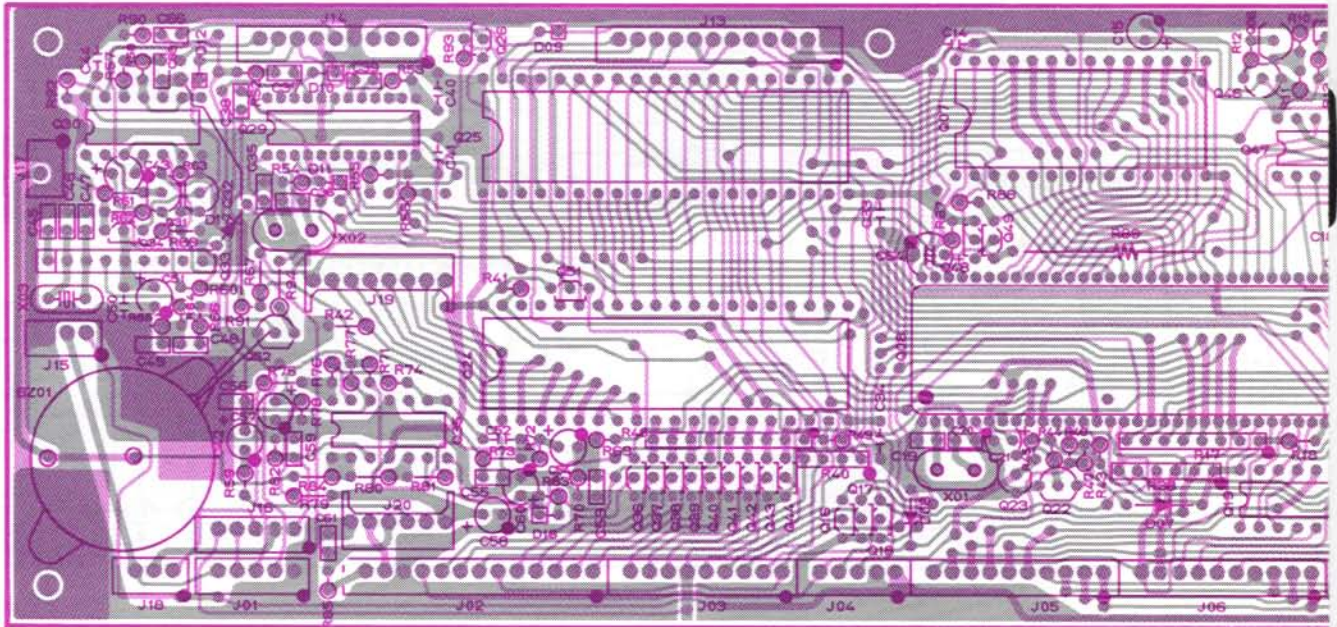

CNTL UNIT IC VOLTAGE CHART

(DC VOLTS)

	CNTL UNIT IC VOLTAGE CHART																				REMARKS	
	1	2	3	4	5	6	7	8	9	10	11	12	13	14	15	16	17	18	19	20		
01007	21	22	23	24	25	26	27	28	29	30	31	32	33	34	35	36	37	38	39	40		
	0	5.00	5.00	5.00	5.00	5.00	5.00	5.00	5.00	5.00	0.07	0.08	0.08	0	1.00	1.50	1.70	1.50	1.60	4.10		
01024	0	0	0	0	0	0	0	0	0	0	5.00	0	0	0	5.00	0	0	5.00	0.04	5.00		
	5.00	5.00	5.00	5.00	2.50	0.52	0.48	0.52	0.52	0.53	0.52	0.55	0.57	5.00	5.00	5.00	1.04	1.10	0.01	5.00		
01025	0	5.00	5.00	5.00	5.00	0	5.00	0	0	0	0	0	0	0	5.00	5.00	0	3.60	5.00	2.50	5.00	
	4.90	5.00	5.00	5.00	2.50	1.00	1.60	1.60	1.80	1.00	1.60	1.60	4.70	5.00	2.60	3.70	5.00	5.00	0.05	0		
01029	2.50	2.5	0	0.30	2.50	0	0	2.50	5.00	2.50	3.30	5.00	2.50	2.50	2.50	2.50	2.50	2.50	2.50	2.50	0	
	2.50	2.50	2.50	0.48																		

CNTL UNIT IC

	CNTL UNIT IC							REMARKS
	1	2	3	4	5	6	7	
01008	18	19	20	21	22	23	24	
	35	36	37	38	39	40	41	
	52	53	54	55	56	57	58	
	0	2.00	-2.00	0	5.00	5.00	4.60	5.00
	0.02	0.03	0.03	5.00	5.00	4.30	5.00	
	5.00	0	5.00	5.00	5.00	5.00	5.00	
	0.70	1.50	1.80	0.90	1.50	1.60	1.60	

※ In the initialize state.

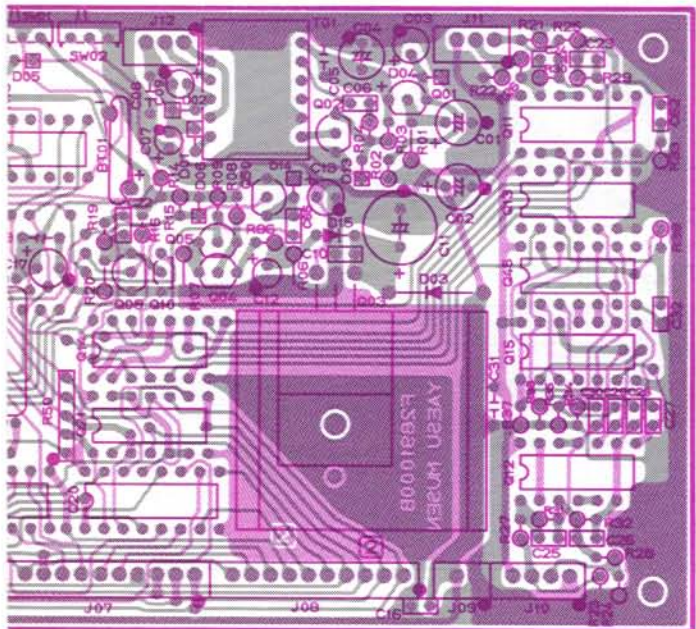

Component side (obverse)

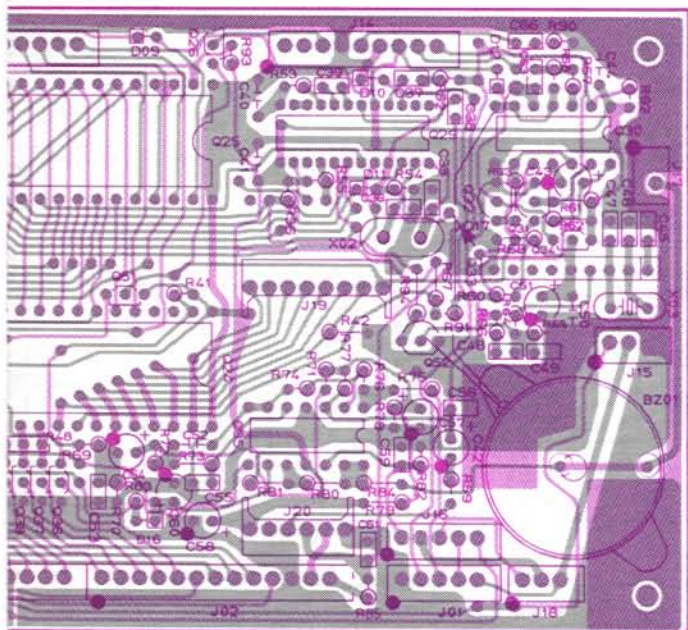

Component side (reverse)

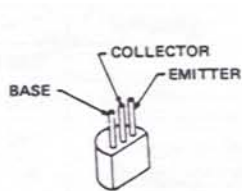

- 2SA733AQ(Q1046)
- 2SC458C
- (Q1004-1006,1009)
- (1022,1023)
- 2SC1384R(Q1002)
- 2SD667C(Q1001)

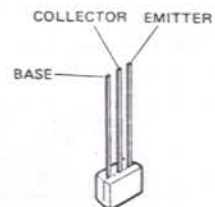

- BA1A4M(Q1049)
- BA1A4P
- (Q1010,1016-1018)
- (1026,1036-1044)
- BN1A4M(Q1048)
- BN1L4L(Q1051)

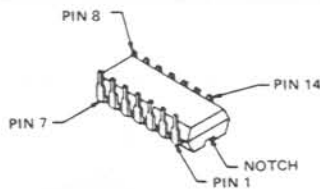

- LA6324(Q1035)
- MC14001BCP(Q1030)
- MC14011BCP(Q1014)
- MC14013BCP(Q1013)
- MC14066BCP(Q1021)
- MC14069UBCP(Q1011,1012)
- MC14072BCP(Q1045)
- MC14081BCP(Q1015)

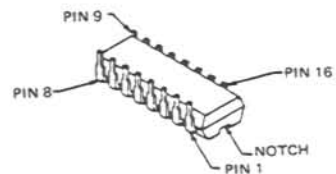

- HD74HC139P(Q1047)
- MC14555BCP(Q1020)
- MC14556BCP(Q1019)
- μPD6302CA(Q1029)

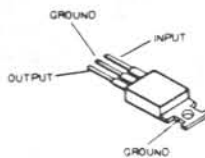

μPC7805H(Q1003)

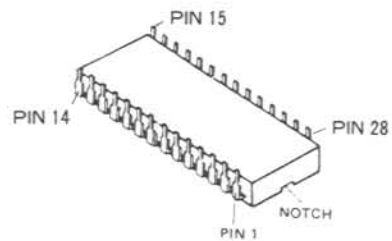

HM6264ALP-12(Q1007)

VOLTAGE CHART

(DC VOLTS)

8	9	10	11	12	13	14	15	16	17	REMARKS
25	26	27	28	29	30	31	32	33	34	
42	43	44	45	46	47	48	49	50	51	
59	60	61	62	63	64					
00	3.80	0	0	5.00	0.80	0.01	0.05	5.00	5.00	
70	4.70	5.00	5.00	0.02	5.00	0.05	4.60	5.00	5.00	
0	5.00	5.00	5.00	5.00	5.00	5.00	5.00	5.00	0.70	
0	4.20	4.70	5.00	3.20	2.50					

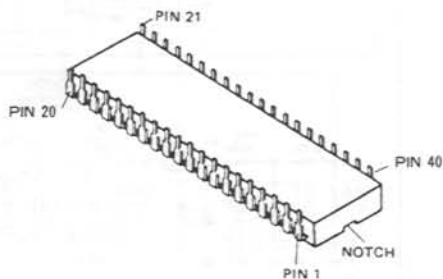

HD63A21P(Q1024,1025)

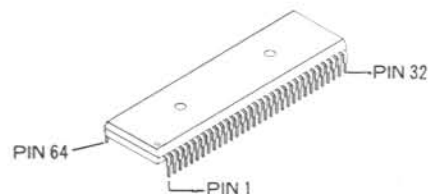

HD63A01Y0(Q1008)

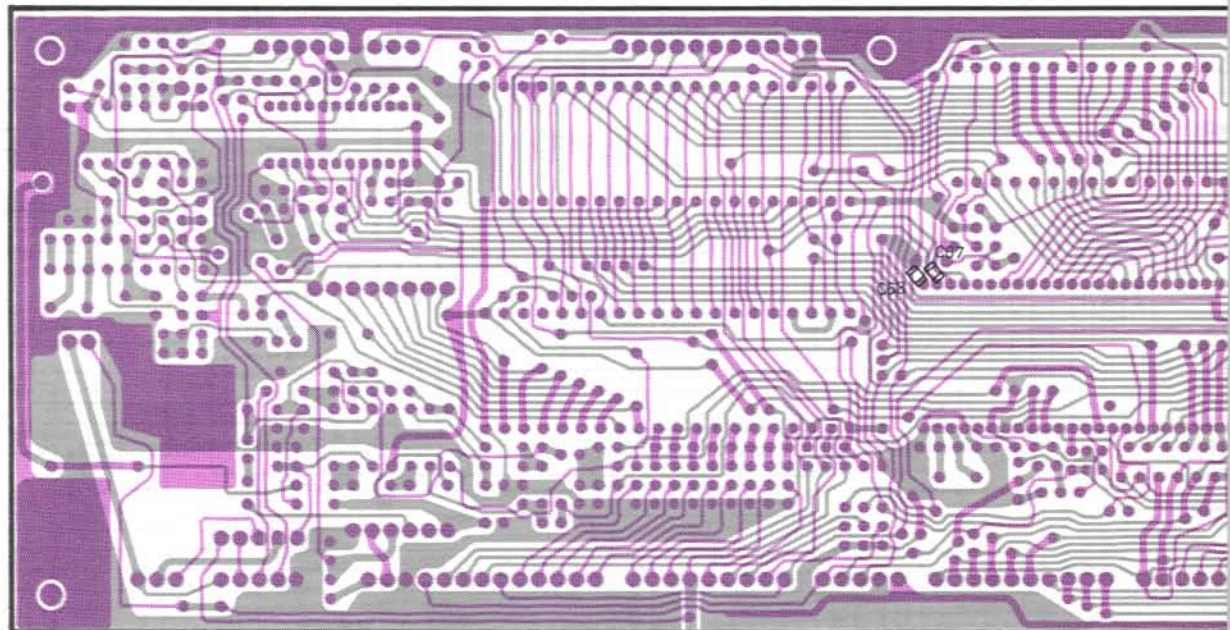
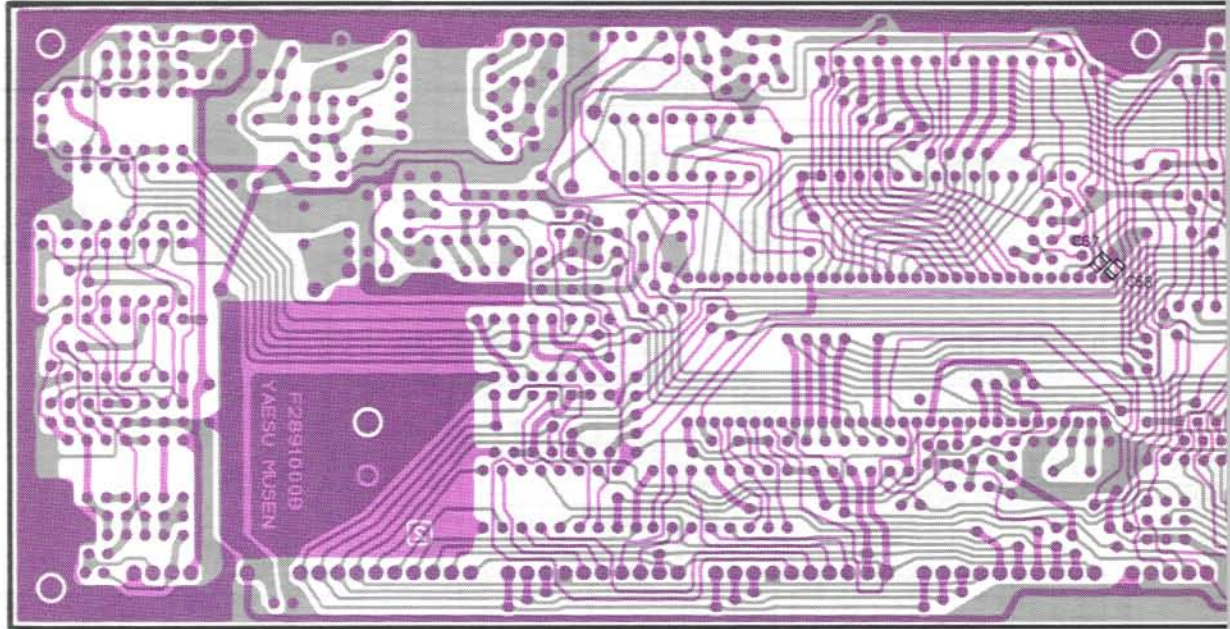

CNTL UNIT VOLTAGE CHART

(DC VOLTS)

	E(S)	C(D)	(G ₁) ^B (G ₂)	REMARKS		E(S)	C(D)	(G ₁) ^B (G ₂)	REMARKS
Q1001	12.3	13.2	13.0		Q1034	5.00	0.14	5.00	
Q1002	0	12.2	-0.7		Q1036	0	0.02	0.02	
Q1004	0.20	0.21	0.90		Q1037	0	8.00	0.02	
Q1005	0.20	4.60	0.21		Q1038	0	0.01	5.00	
Q1006	0	0.06	0.66		Q1039	0	0.10	0.03	
Q1009	0	5.0	0		Q1040	0	8.00	0.03	
Q1010	0	0	0.03		Q1041	0	4.80	0.04	
Q1016	0	0.70	0.06		Q1042	0	0.02	5.00	
Q1017	0	0.01	4.60		Q1043	0	7.90	0.03	
Q1018	0	0.03	4.60		Q1044	0	7.90	0.03	
Q1022	0	0.77	0.05		Q1046	5.0	5.0	4.4	
Q1023	0	5.00	0.77		Q1048	5.00	5.00	0.02	
Q1026	0.04	12.70	0		Q1049	0	0.02	1.60	
Q1031	0	5.00	0.01		Q1051	5.0	0.1	4.6	
Q1032	0	5.0	0						

CNTL UNIT IC VOLTA

	1(IN)	2(ND)	3(UT)	4	5	6	7	8	9	10	11
Q1003	13.0	0	5.0								
Q1011	L	H	H	L	H	L	0	H	L	L	H
Q1012	L	H	L	H	H	L	0	L	H	H	L
Q1013	H	L	L	L	L	L	0	L	L	H	L
Q1014	H	H	L	L	H	H	0	L	L	H	H
Q1015	L	L	L	L	L	L	0	L	L	H	L
Q1019	H	L	H	H	H	H	H	0	H	H	H
Q1020	H	L	H	L	L	L	L	0	L	H	L
Q1021	L	L	H	L	L	L	0	L	L	L	H
Q1030	L	L	H	L	L	H	0	L	L	H	L
Q1033	0	0.02	0.06	0	0.14	0.10	0.13	0			
Q1035	0	0	0	5.00	0.69	0.01	3.90	2.51	2.45	0	
Q1045	L	L	L	L	L	L	0	L	L	L	L
Q1047	L	H	H	H	H	H	L	0	H	H	H

CNTL UNIT PARTS LAYOUT

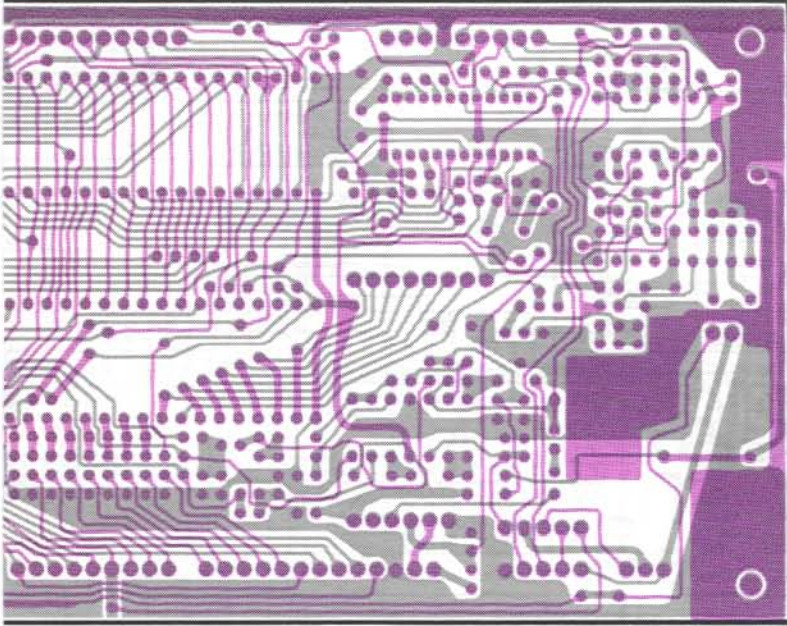

Chip side (obverse)

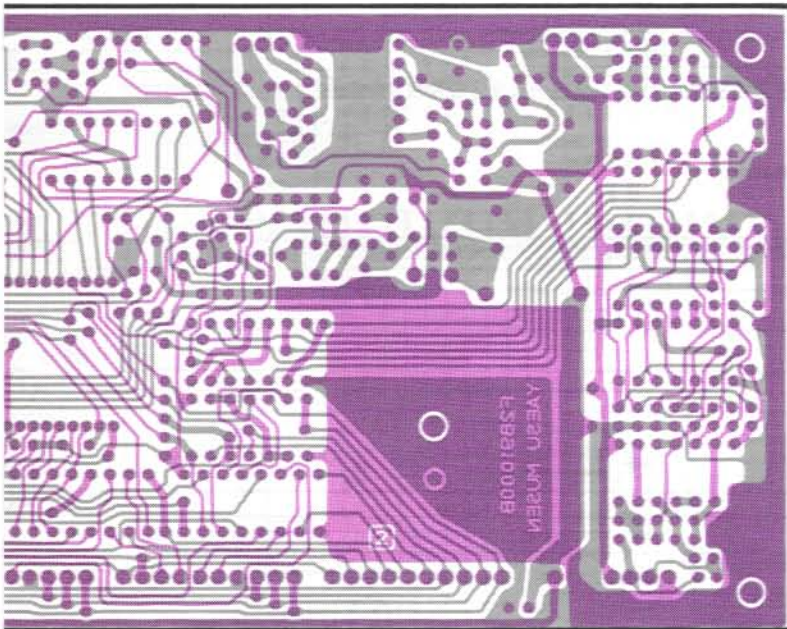

Chip side (reverse)

LOGIC CHART

(DC VOLTS)

12	13	14	15	16	17	18	REMARKS
							H \neq 5.0
H	L	5.0					L \neq 0
L	H	5.0					
H	L	5.0					
H	L	5.0					
H	H	L	H	5.0			
L	H	L	L	5.0			
L	L	5.0					
L	H	5.0					
250	243	246					
L	L	5.0					
H	H	H	H	5.0			

※ In the initialize state.

CNTL UNIT CIRCUIT DIAGRAM

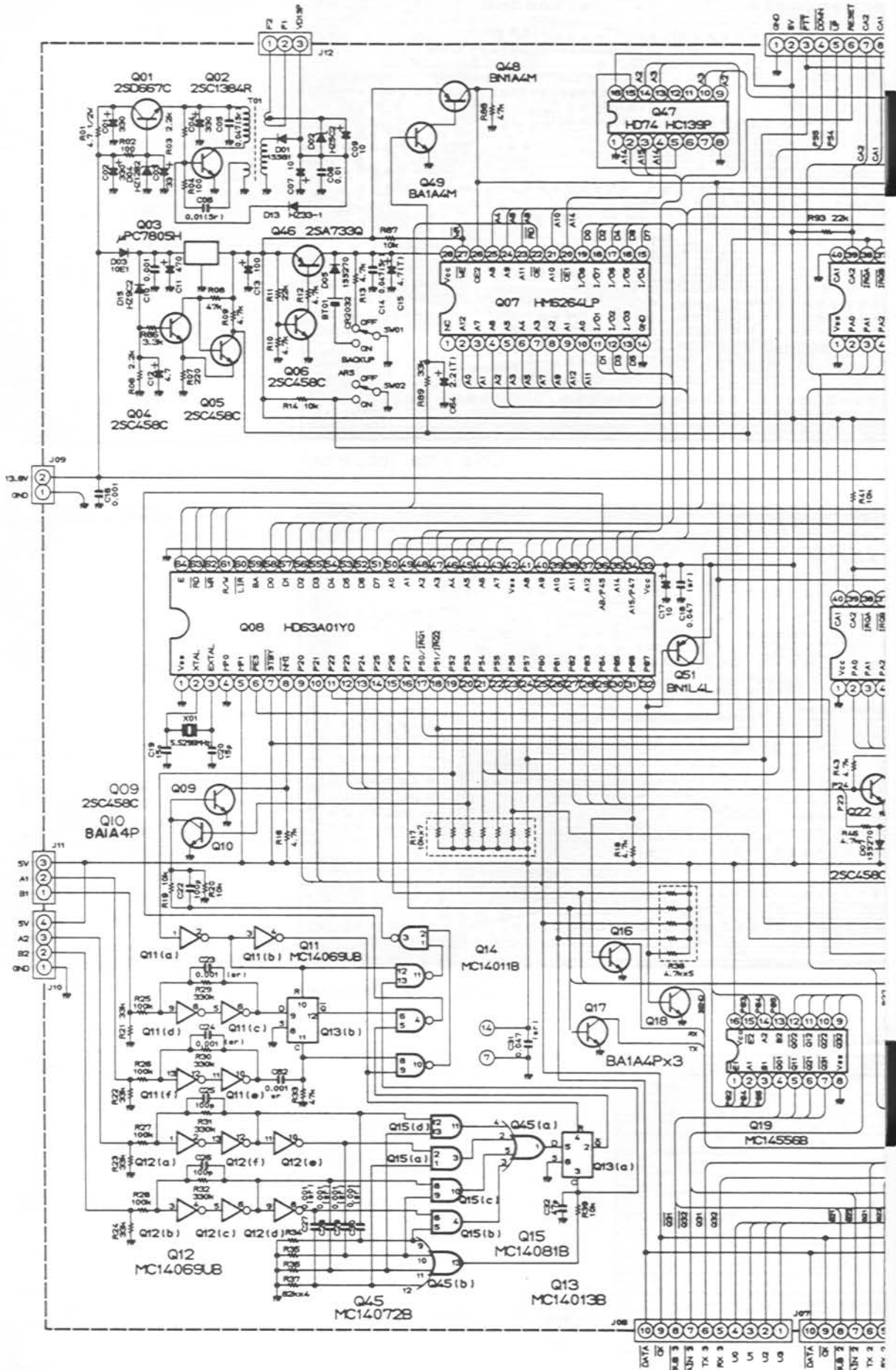

DISPLAY UNIT (No. 2XXX)

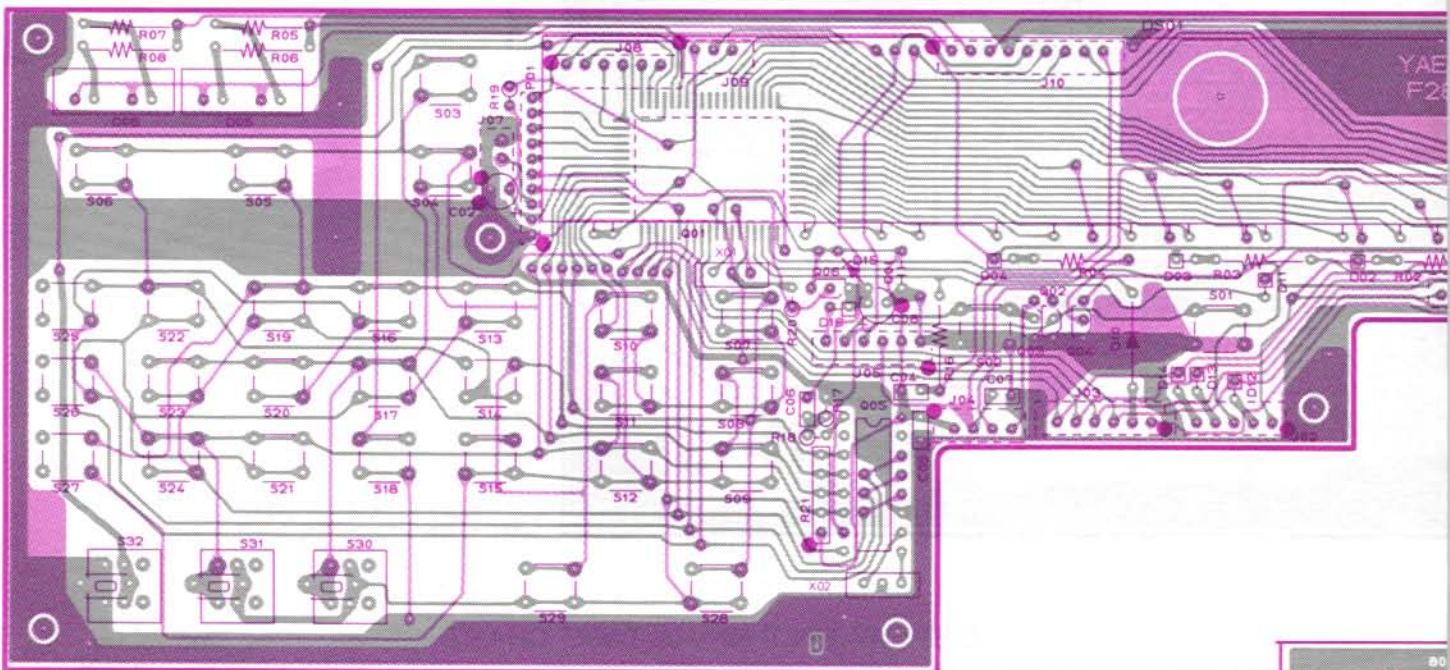
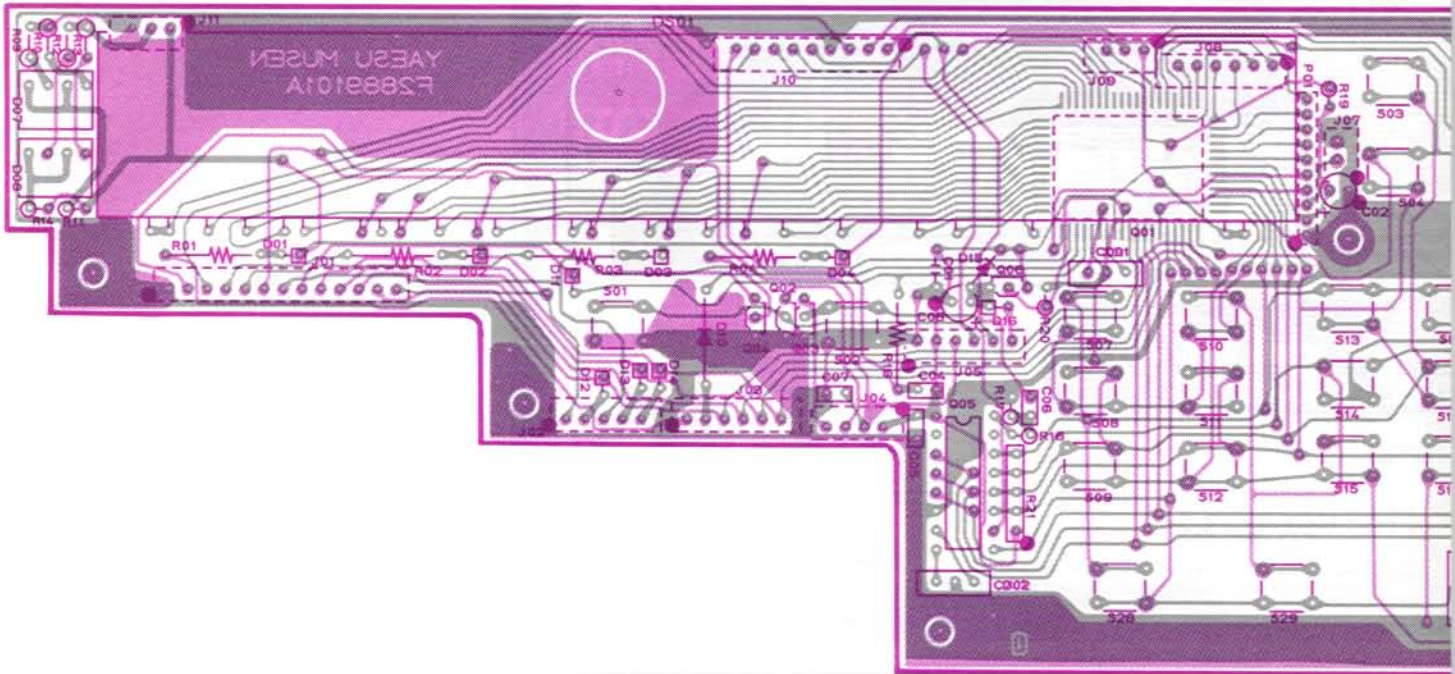

Display side (reverse)

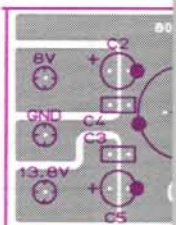

Component s

and PROTECTOR UNIT PARTS LAYOUT

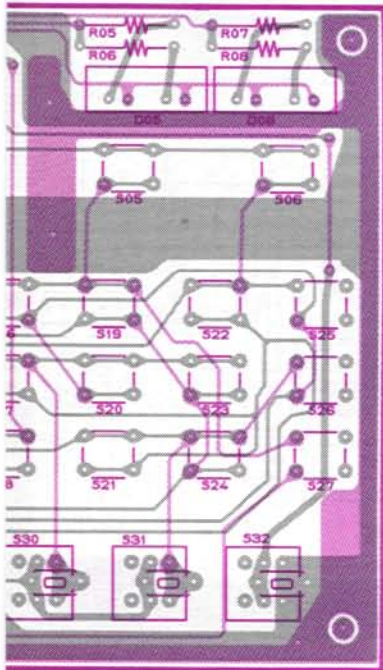

Display side (obverse)

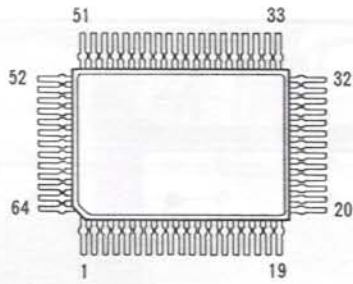

HD614022FH35(Q2001)

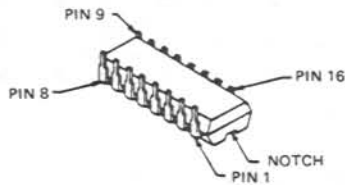

LR4087(Q2005)

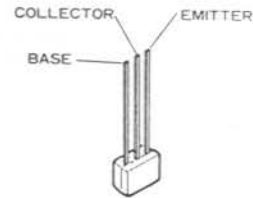

BA1A4P(Q2002-2004)
BN1A4P(Q2006)

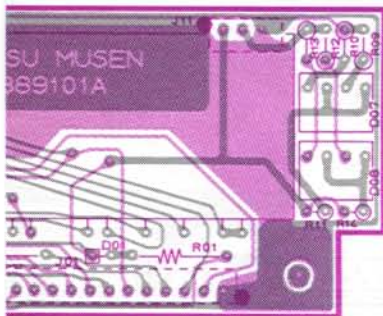

PROTECTOR UNIT (No. 7XX)

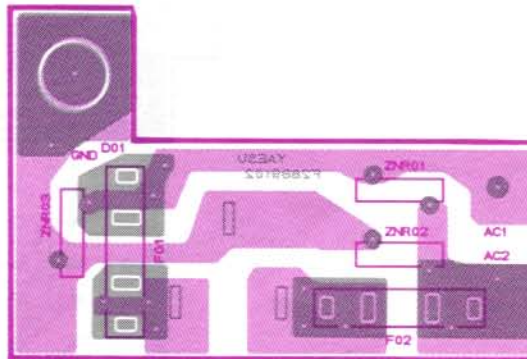

Component side (obverse)

REG UNIT (No. 8XX)

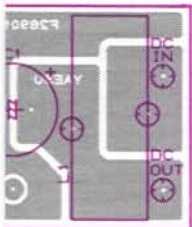

side (obverse)



Component side (reverse)

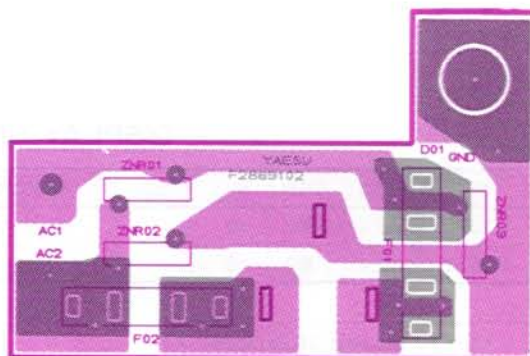

Component side (reverse)

DISPLAY UNIT PARTS LAYOUT

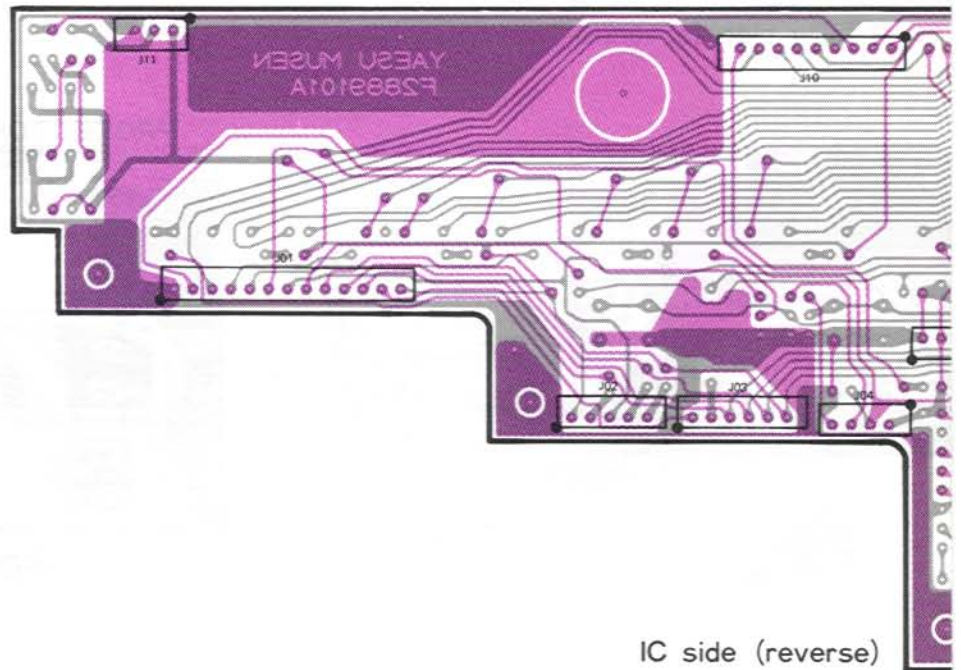
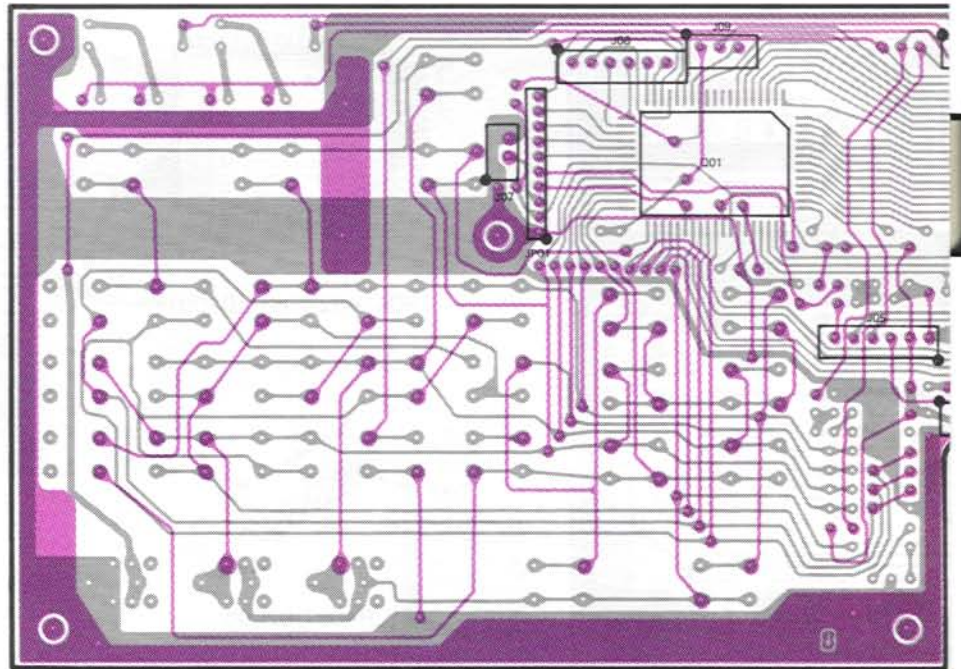

IC side (reverse)

DISPLAY UNIT VOLTAGE CHART

(DC VOLTS)

	E(S)	C(D)	(G ₁) ^B	(G ₂)	REMARKS		E(S)	C(D)	(G ₁) ^B	(G ₂)	REMARKS
Q2002	0	5.0	0			Q2004	0	12.0	0		
Q2003	0	5.0	0			Q2006	0	5.0	0		

※ In the initialize state.

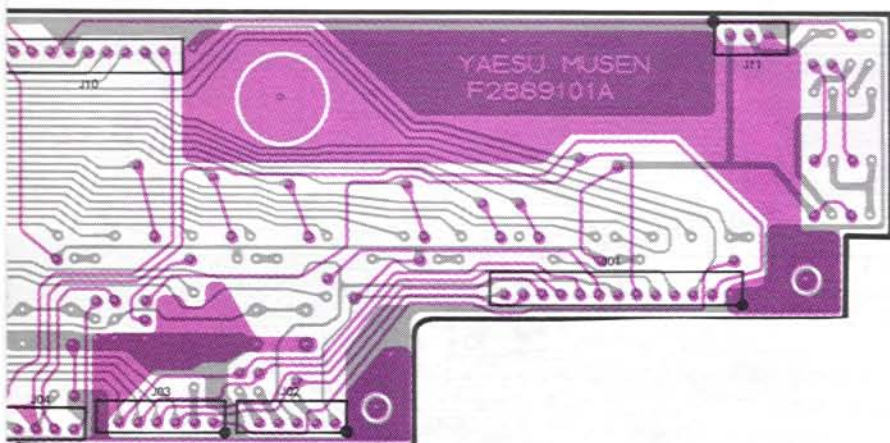

IC side (obverse)

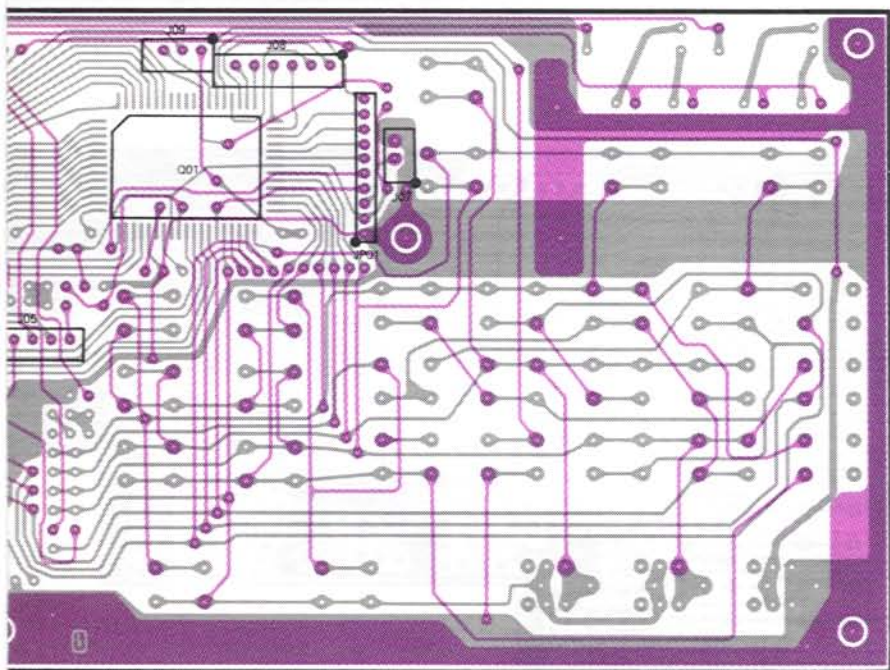

DISPLAY UNIT IC VOLTAGE CHART

(DC VOLTS)

	1	2	3	4	5	6	7	8	9	10	11	12	13	14	15	16	17	REMARKS
	18	19	20	21	22	23	24	25	26	27	28	29	30	31	32	33	34	
	35	36	37	38	39	40	41	42	43	44	45	46	47	48	49	50	51	
	52	53	54	55	56	57	58	59	60	61	62	63	64					
Q2001	-10.50	-32.00	-10.50	-13.60	-16.60	-19.80	-25.80	—	—	—	—	4.80	-32.20	5.00	5.00	5.00	5.00	
	5.00	5.00	5.00	5.00	0	0.05	0	0.01	5.0	5.00	5.00	5.00	5.00	1.10	1.00	1.05	0.35	
	0.37	0.38	0.38	0	5.00	5.00	5.00	5.00	0	5.00	0.24	2.40	0	5.00	1.10	0.80	1.05	
	-29.20	-29.20	-29.20	-29.20	-29.20	-24.00	-29.20	-29.20	-29.20	-29.20	-29.20	-29.20	-19.70					
Q2005	5.0	5.0	0	0	0	0	0	5.0	0	0	5.0	5.0	5.0	5.0	5.0	0		

DISPLAY UNIT F2889101 (No.2xxx)

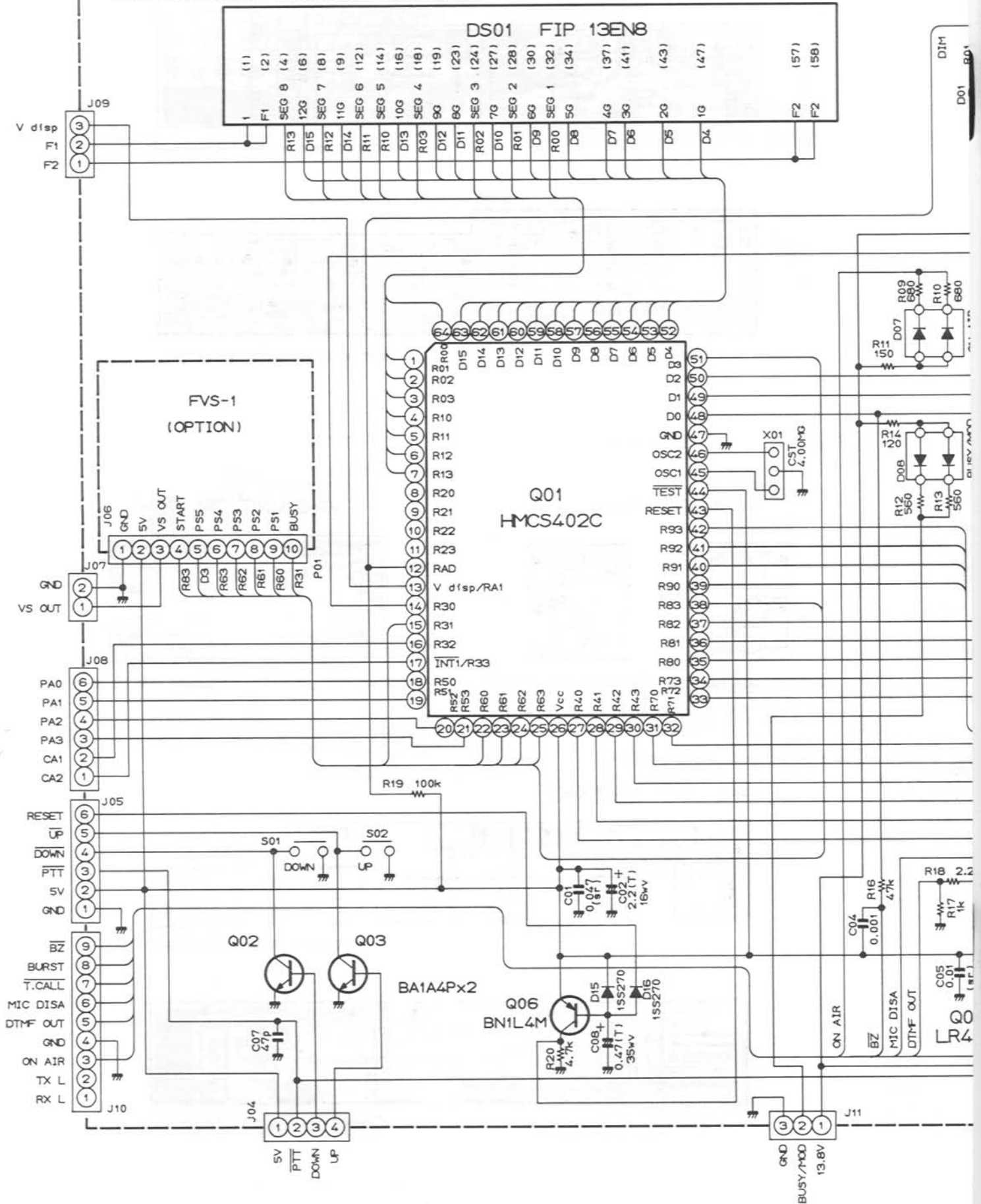

DISPLAY UNIT CIRCUIT DIAGRAM

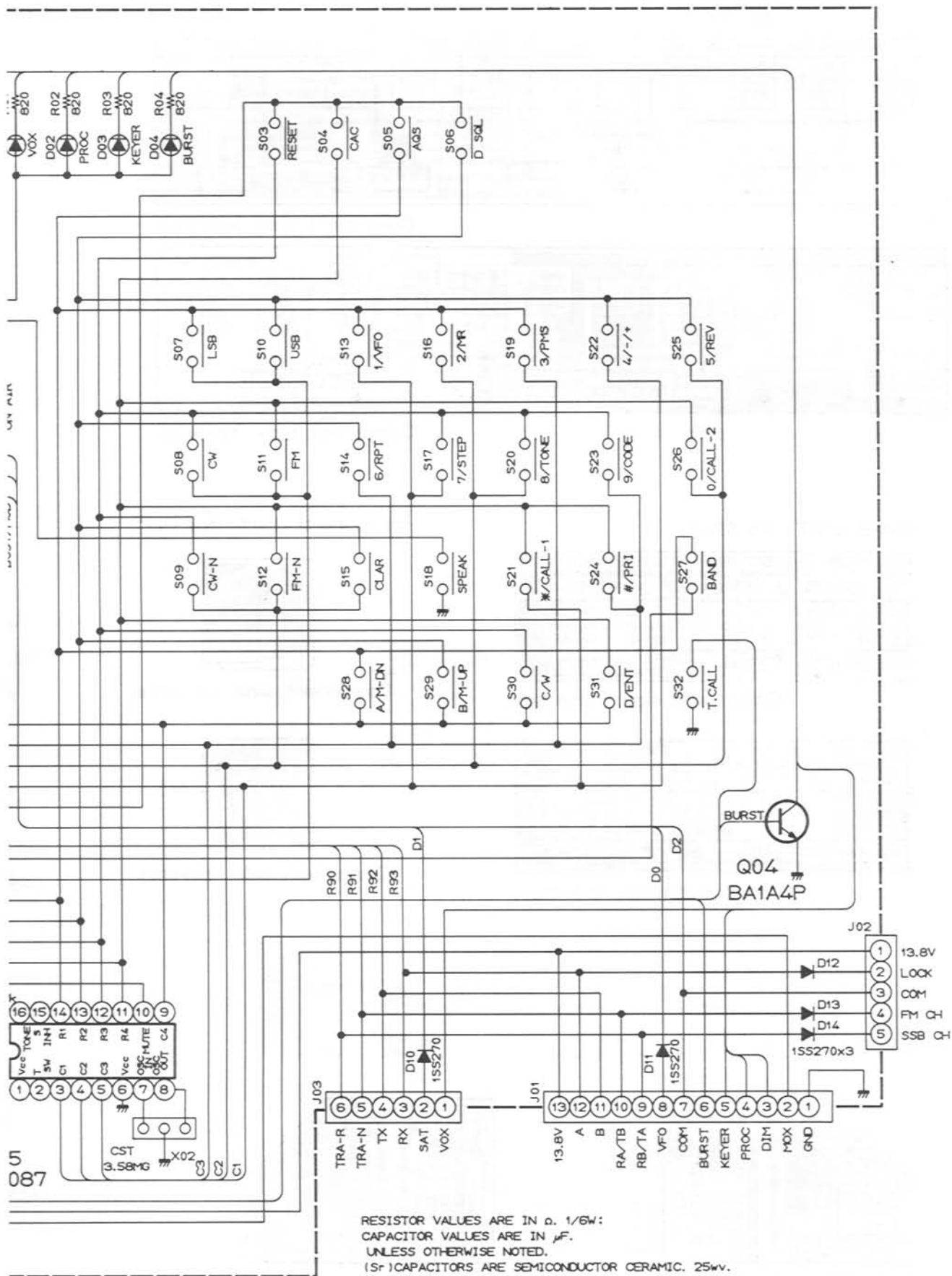

SW, ENCODER and VR UNIT PARTS LAY

SW-A UNIT (No. 3XX)

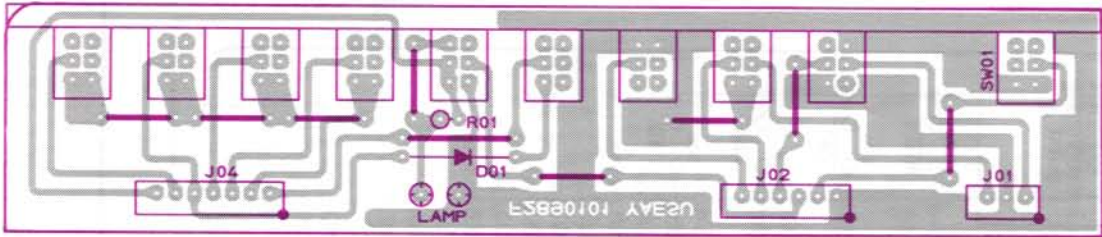

Component side (obverse)

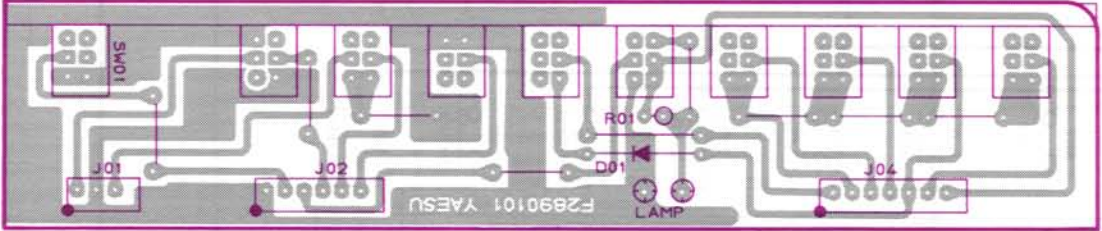

Component side (reverse)

SW-B UNIT (No. 6XX)

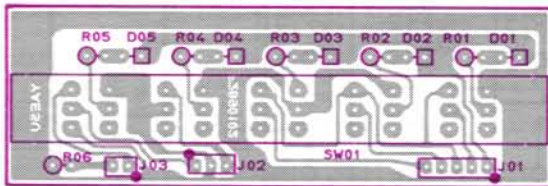

Component side (obverse)

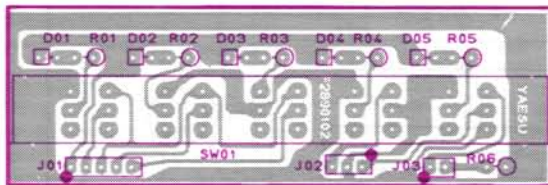

Component side (reverse)

ENCODER UNIT (No. 55X)

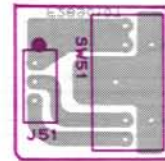

Component side (obverse)

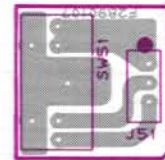

Component side (reverse)

SW-C UNIT (No. 1XX)

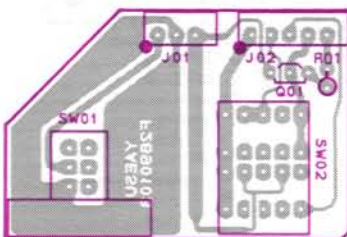

Component side (obverse)

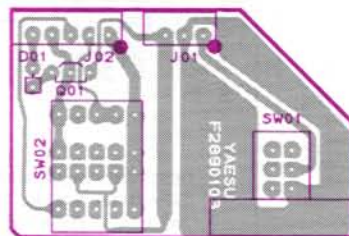

Component side (reverse)

* Circuit Diagram is as shown page 25.

BASE
2SA733
GROUND
OUTPUT

μPC7801
L7809(C)

2SC3420

MIC
DTM
C

VR-A UNIT (No. 4XX)

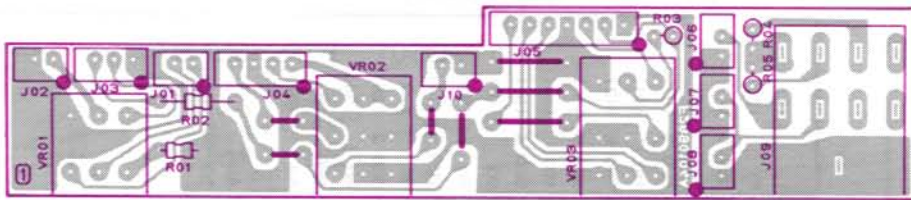

Component side (obverse)

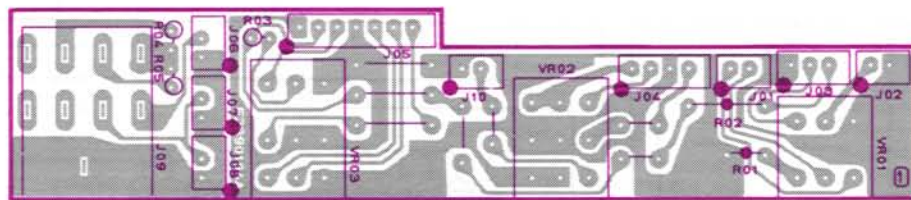

Component side (reverse)

VR-B UNIT (No. 5XX)

VR-D UNIT (No. 9XX)

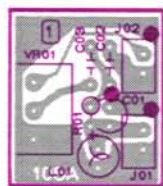
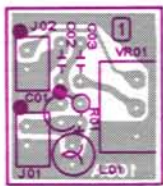

Component side (obverse) Component side (reverse)

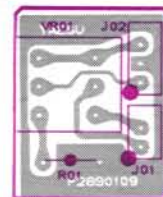
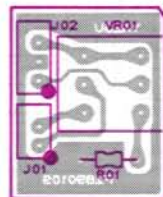

Component side (obverse) Component side (reverse)

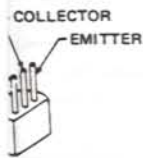

AQ(Q101)

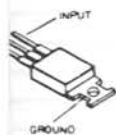

3H(Q1)
2,03

VR-C UNIT (No. 2XX)

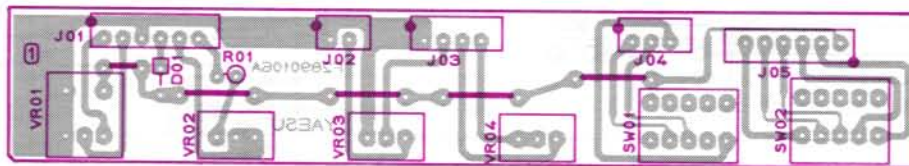

Component side (obverse)

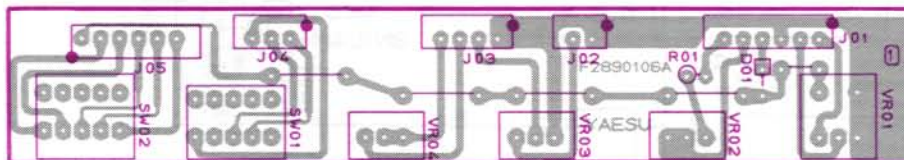

Component side (reverse)



YGR(Q4)

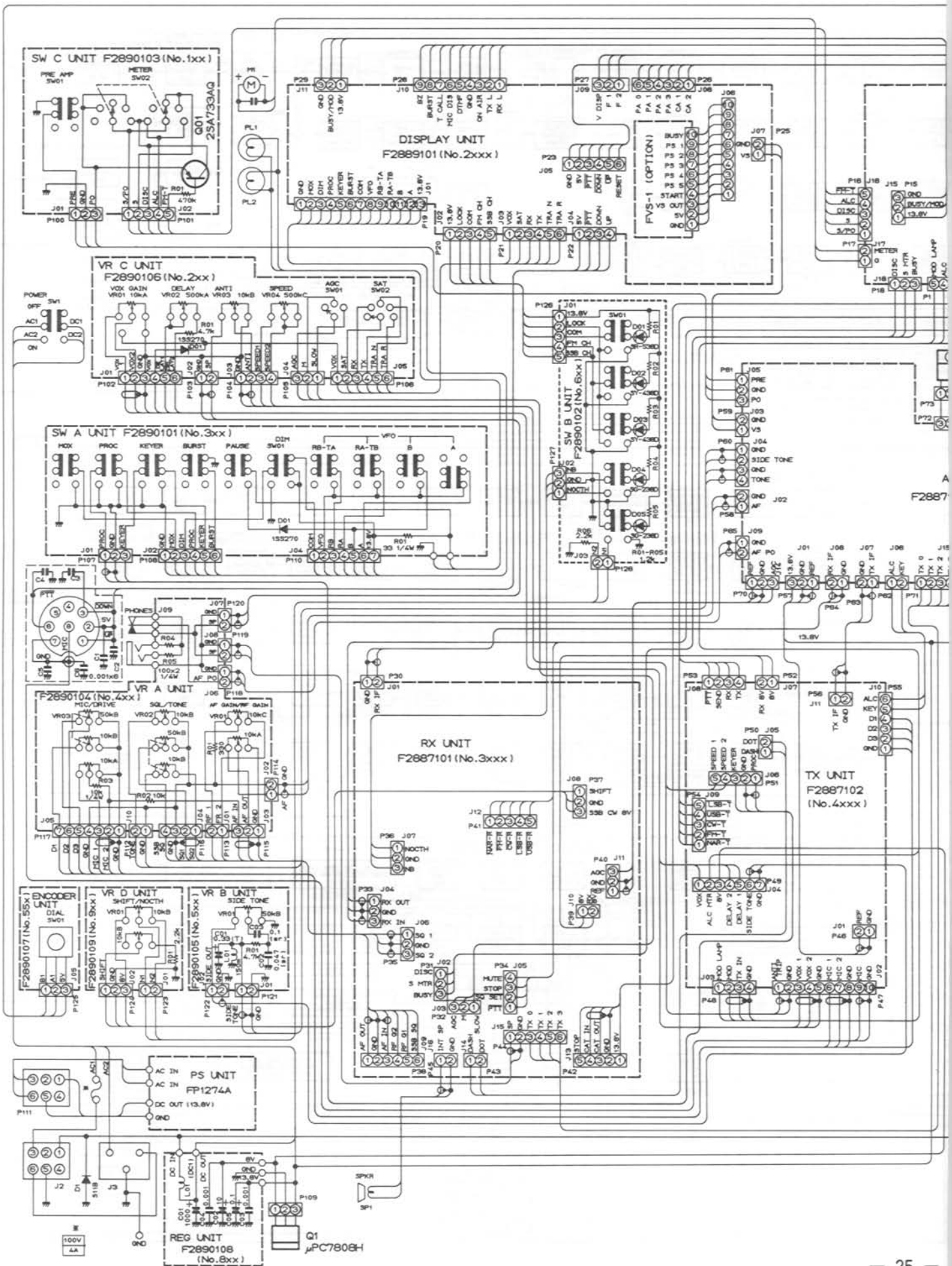

CONNECTION DIAGRAM

R

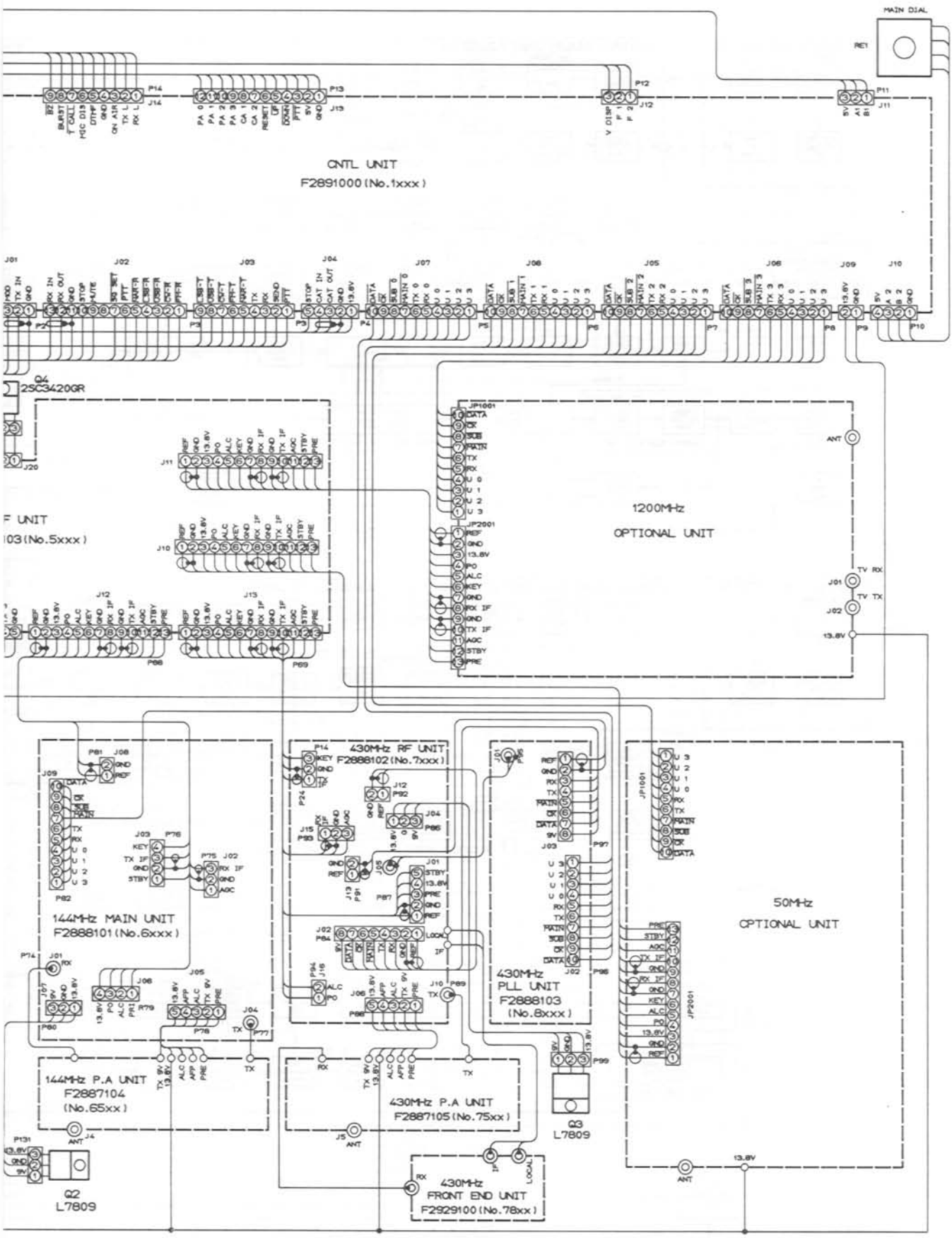

RESISTOR VALUES ARE IN Ω , 1/W:
 CAPACITOR VALUES ARE IN μ F
 (T) CAPACITORS ARE TANTALUM
 (C) CAPACITORS ARE SEMI-CONDUCTOR CERAMIC, 25VDC, UNLESS OTHERWISE NOTED.

TX/RX PLL DATA

BLOCK DIAGRAM

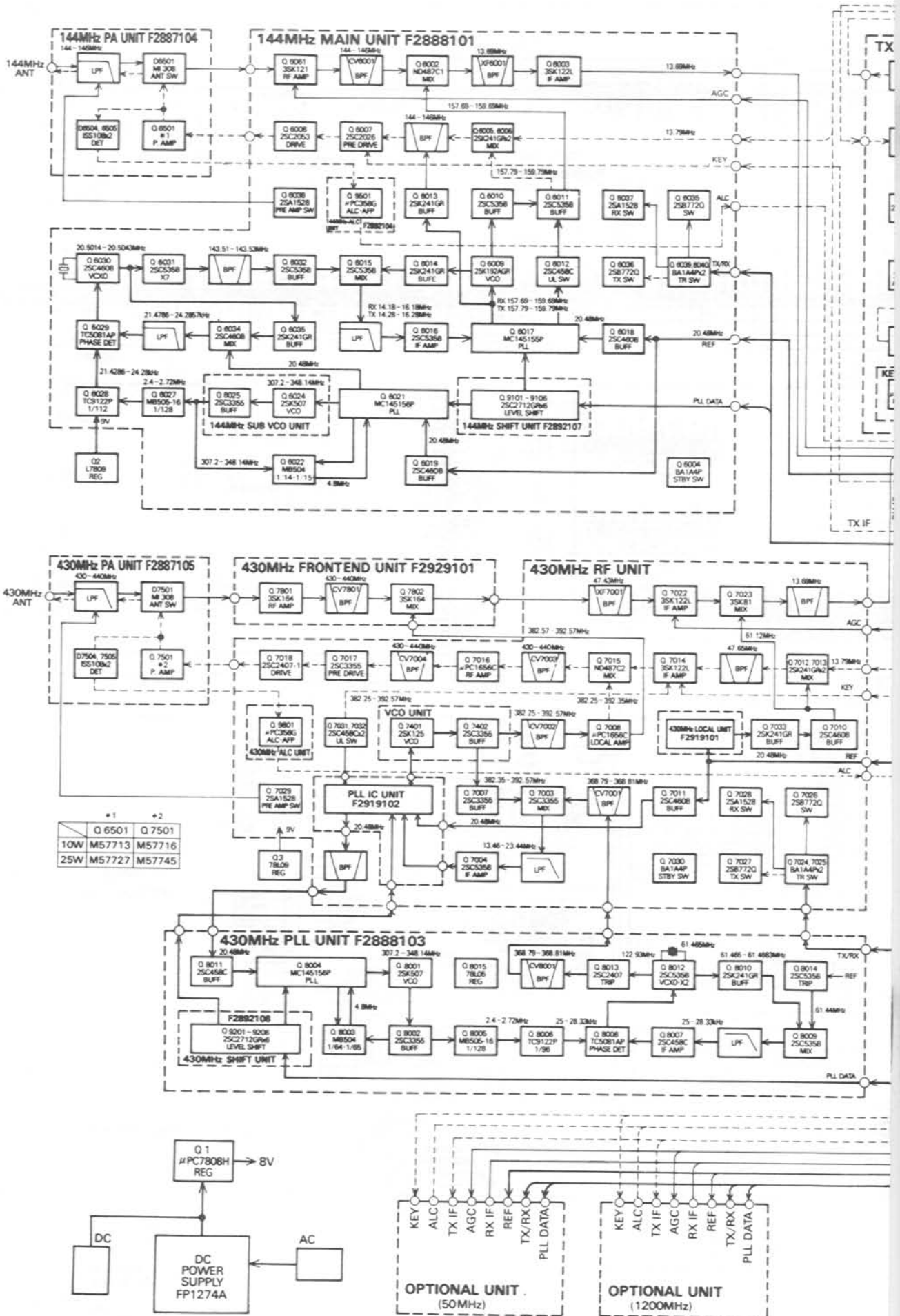

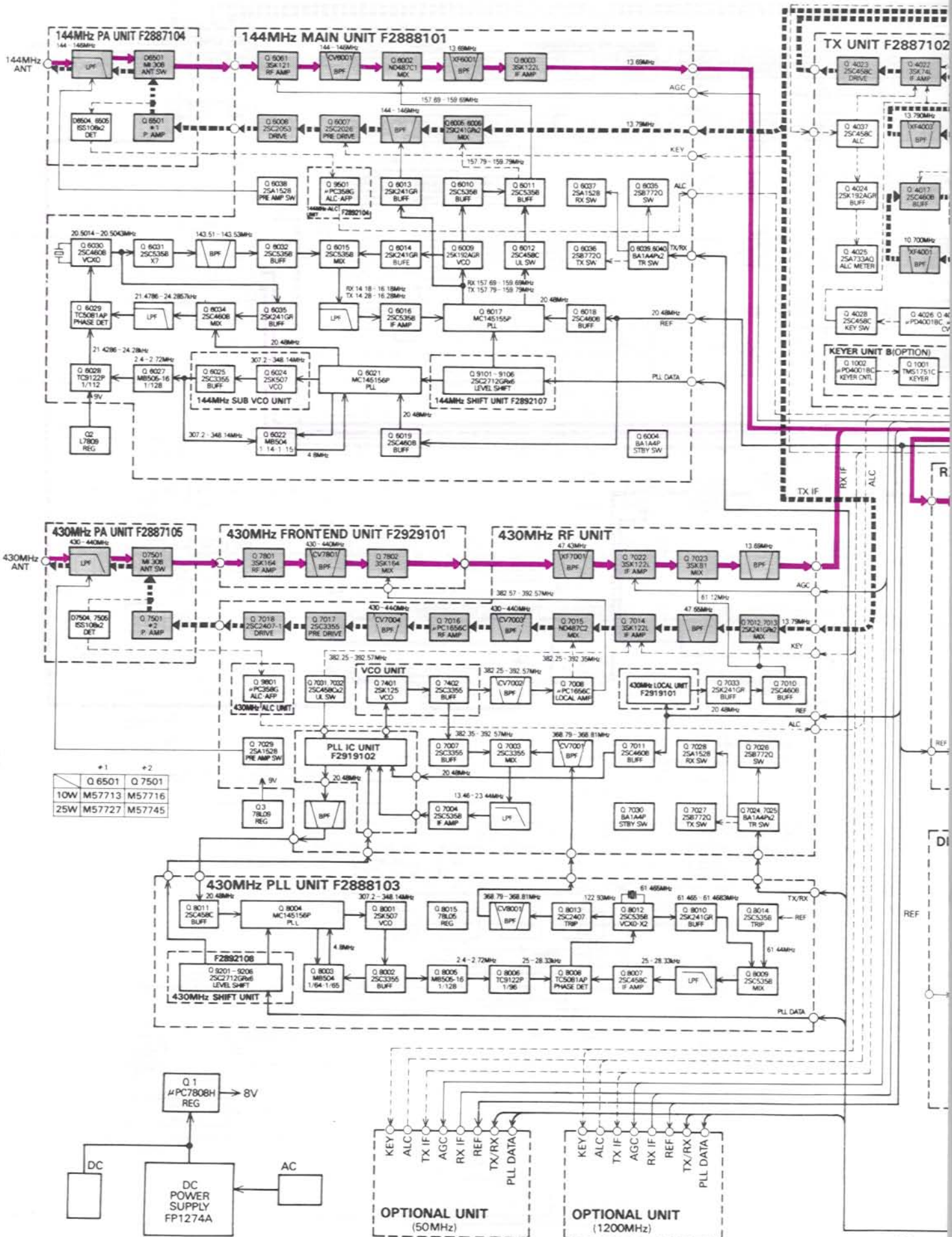

	*1	Q 6501	Q 7501
10W	M57713	M57716	
25W	M57727	M57745	

OPTIONAL UNIT (50MHz)

OPTIONAL UNIT (1200MHz)

SIGNAL TRACING (SSB MODE)

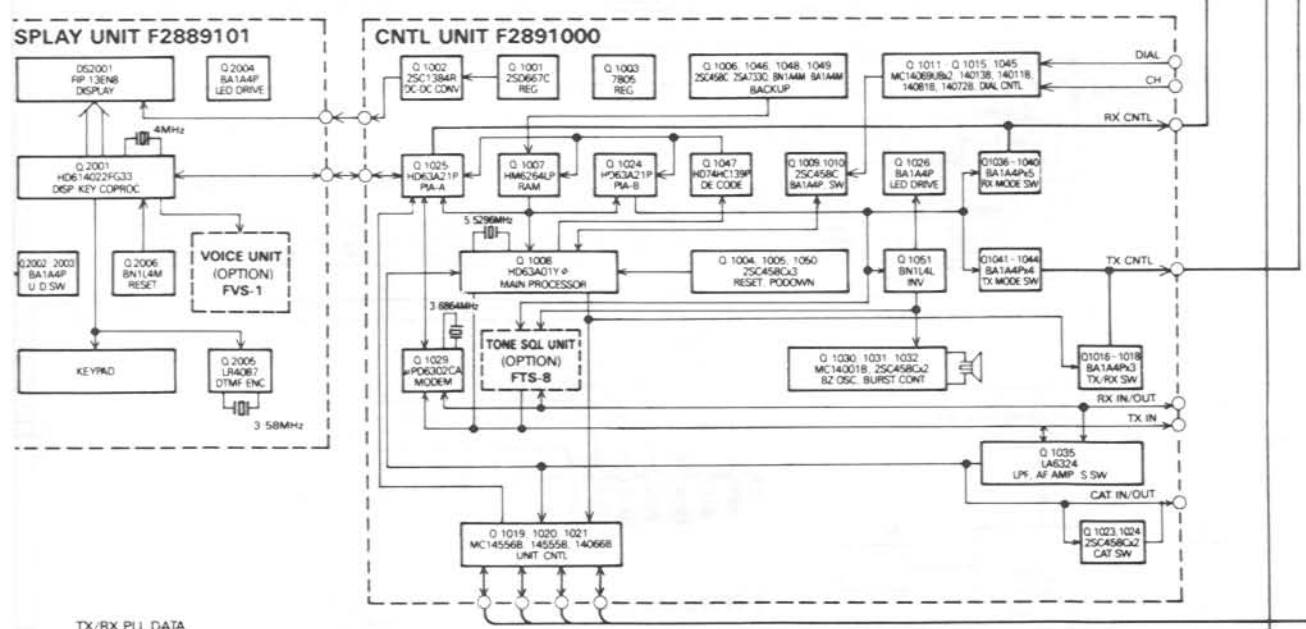
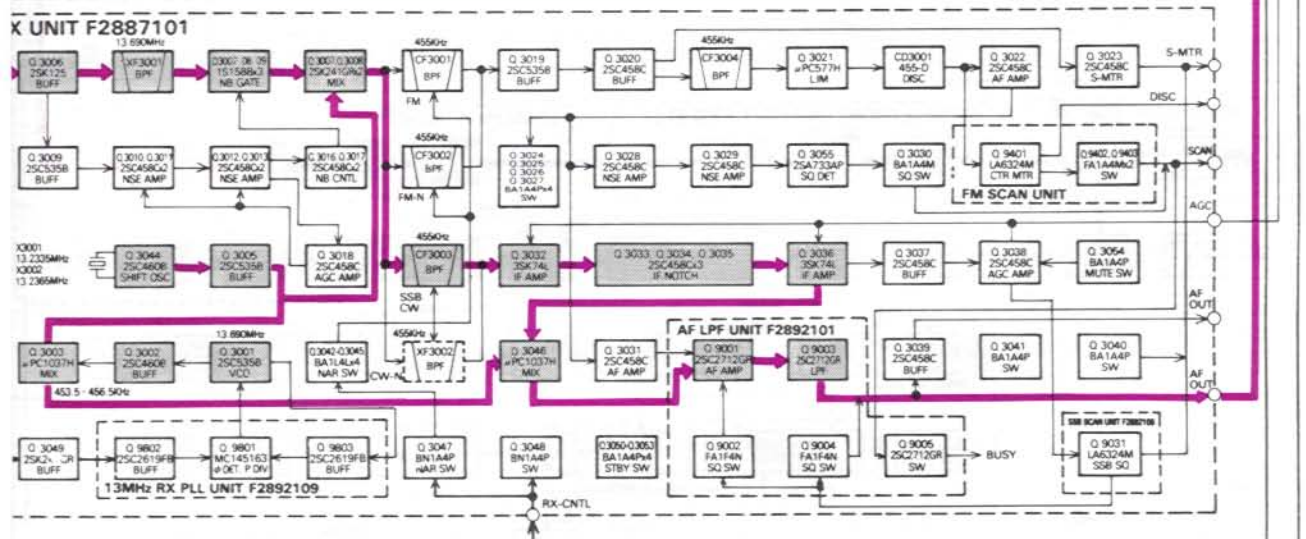
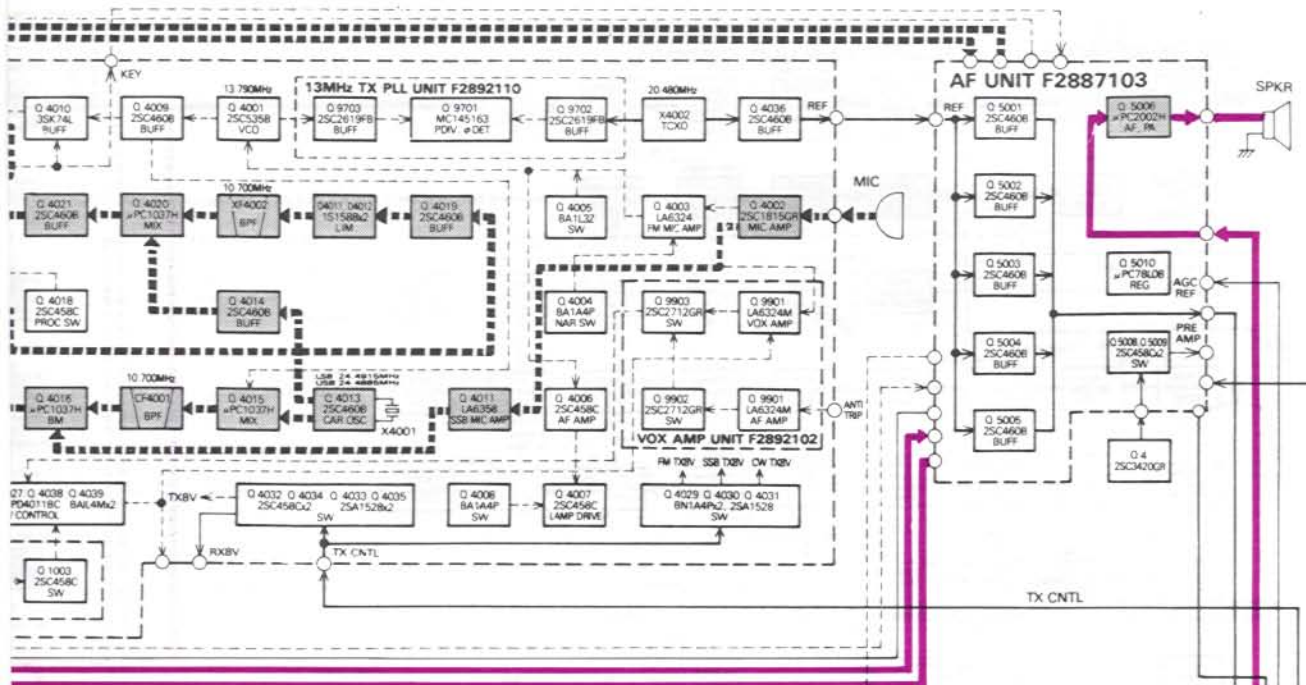

TX/RX PLL DATA

TX/RX PLL DATA

TX/RX PLL DATA

SIGNAL TRACING (CW MODE)

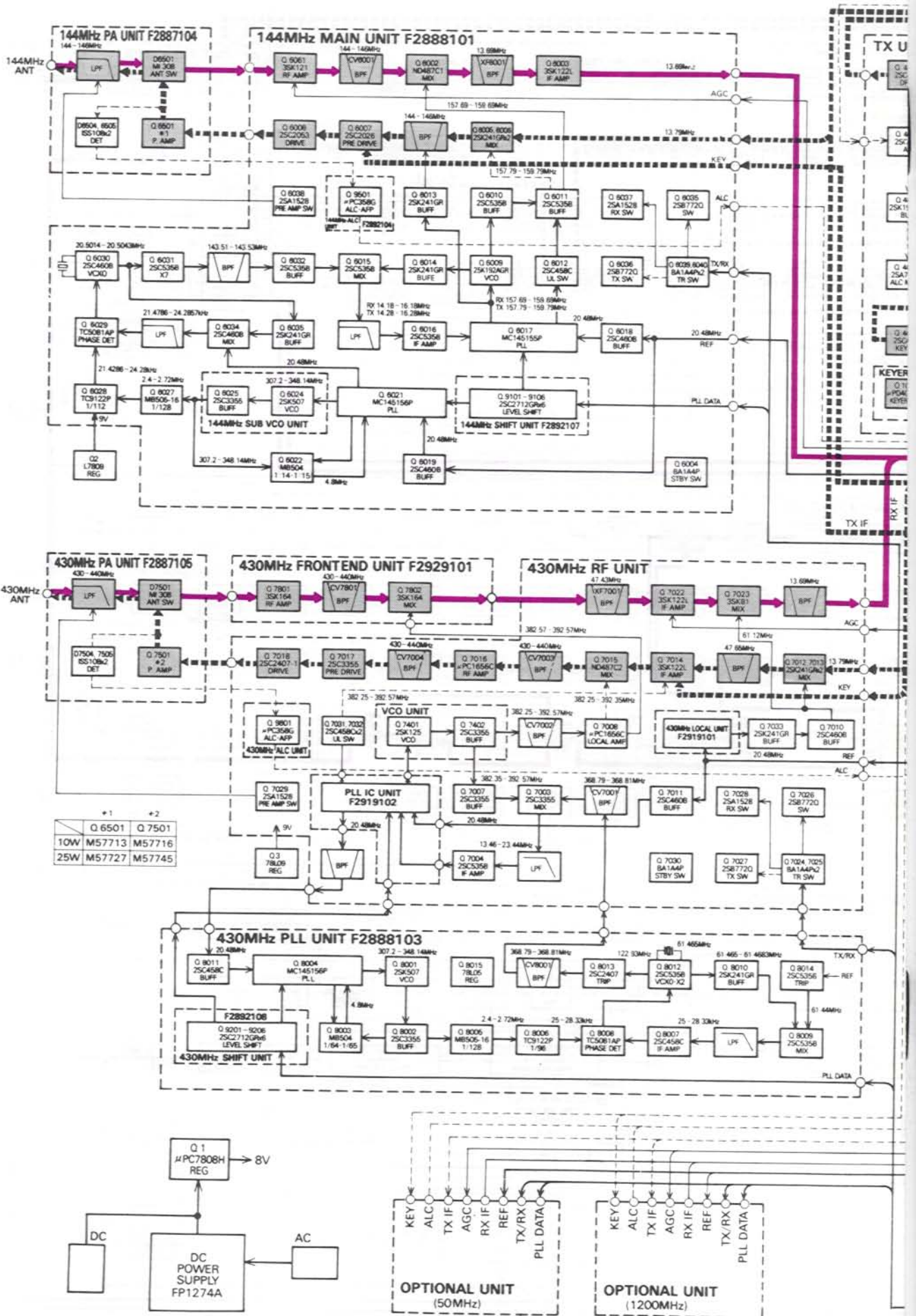

14

43

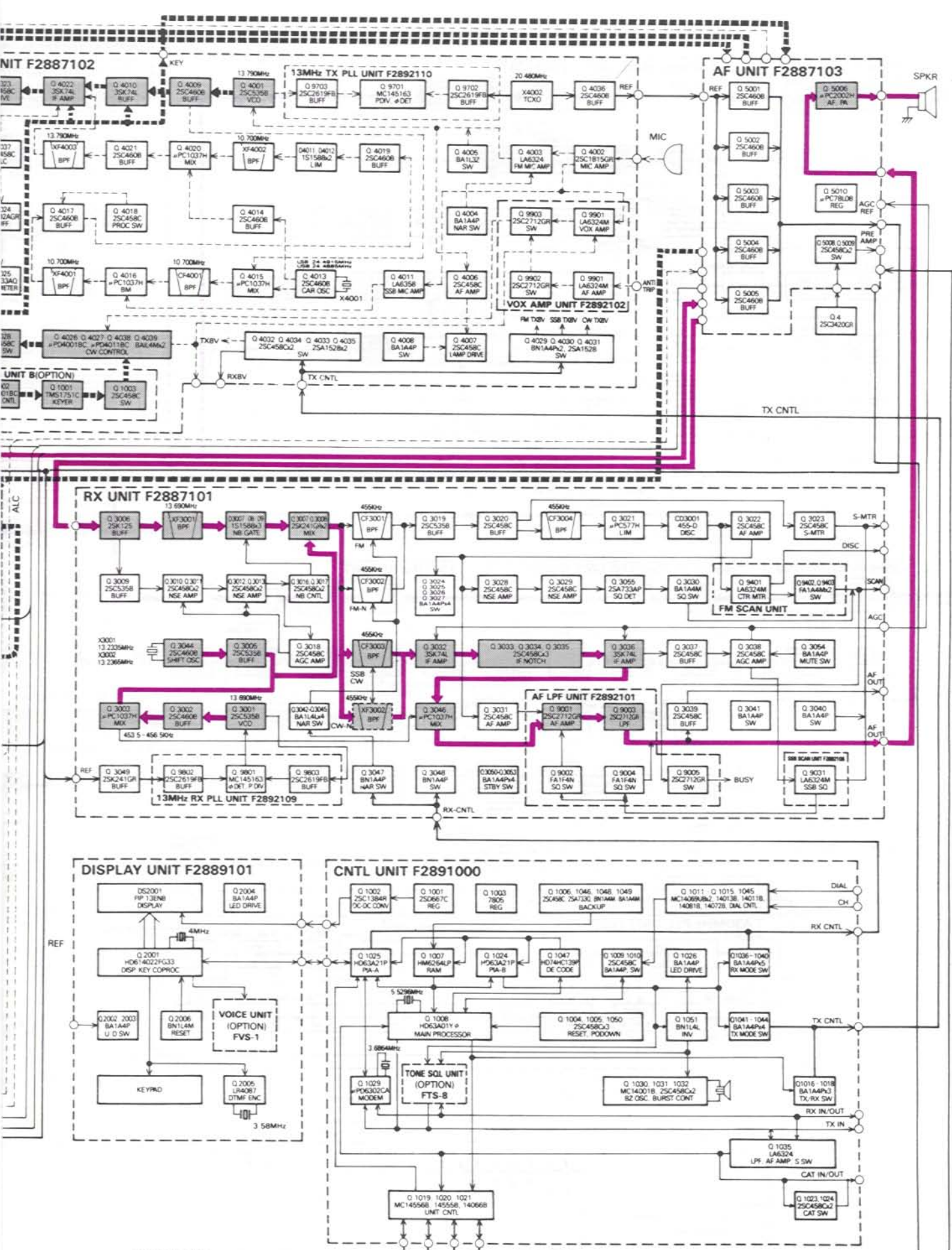

TX/RX PLL DATA

SEMICONDUCTOR CROSS-REFERENCE

◎ MAIN CHASSIS

Symbol No.	ORIGINAL	REPLACEMENT	REPLACEMENT	REPLACEMENT
	Part No.	Part No.	Part No.	Part No.
Q4	2SC3420GR	2SD1667		
	G3334200G	G3416670		
Q1	μPC7808H	L7808		
	G1090294	G1090777		

◎ AF UNIT

Symbol No.	ORIGINAL
	Part No.
D5008,5009	2SC458C
	G3304580C

◎ RX UNIT

Symbol No.	ORIGINAL	REPLACEMENT	REPLACEMENT	REPLACEMENT
	Part No.	Part No.	Part No.	Part No.
Q3030	BA1A4M	2SC3402		
	G3090074	G3334020		
D3005,3006,3028,3030, 3034,3035,3037,3038, 3039,3040,3041,3042, 3043,3044,3045,3046, 3047,3049,3050,3051, 3052	1SS270	1SS53		
	G2090408	G2090027		
D3036,3048	1SS270TJ	1SS53T1		
	G2060004	G2060002		

◎ 144MHz MAIN UNIT

Symbol No.	ORIGINAL
	Part No.
D6035,6036	2SB7720
	G32077200
D6012	2SC458C
	G3304580C
D6001,6014,6019,6020, 6021,6022,6023,6024, 6025,6026,6027,6028, 6029,6030,6031	1SS270
	G2090408
D6032	1SS270TJ
	G2060004

◎ AF LPF UNIT

Symbol No.	ORIGINAL	REPLACEMENT	REPLACEMENT	REPLACEMENT
	Part No.	Part No.	Part No.	Part No.
D9001,9002,9003, 9004,9005	2SC2712GR TE85R	2SC1623 L6/L7	2SC2812 L6/L7	2SC2462 LC/LD
	G3327127G	G3316237 F/G	G3328127 F/G	G3324627 C/D

◎ 144MHz ALC UNIT

Symbol No.	ORIGINAL
	Part No.
D9501,9502	1SS181 TE85R
	G2070001

◎ FM SCAN UNIT

Symbol No.	ORIGINAL	REPLACEMENT	REPLACEMENT	REPLACEMENT
	Part No.	Part No.	Part No.	Part No.
D9401	1SS184 TE85R	DCB015-TA	MC2838-T14-2	
	G2070009	G2070012	G2070018	

◎ 144MHz SHIFT UNIT

Symbol No.	ORIGINAL
	Part No.
D9101,9102,9103, 9104,9105,9106	2SC2712GR TE85R
	G3327127G

◎ SSB SCAN UNIT

Symbol No.	ORIGINAL	REPLACEMENT	REPLACEMENT	REPLACEMENT
	Part No.	Part No.	Part No.	Part No.
D9301	1SS184 TE85R	DCB015-TA	MC2838-T14-2	
	G2070009	G2070012	G2070018	

◎ 430MHz RF UNIT

Symbol No.	ORIGINAL
	Part No.
D7026,7027	2SB7720
	G32077200
D7031,7032	2SC458C
	G3304580C
D7003,7014,7015, 7016,7017,7018	1SS270
	G2090408
D7006,7011	1SS270TJ
	G2060004

◎ TX UNIT

Symbol No.	ORIGINAL	REPLACEMENT	REPLACEMENT	REPLACEMENT
	Part No.	Part No.	Part No.	Part No.
Q4032,4034	2SC458C	2SC945AP		
	G3304580C	G3309451P		
Q4005	BA1L3Z	2SC3901		
	G3090077	G3339010		
Q4038,4039	BA1L4M	2SC3399		
	G3090080	G3333990		
Q4003	LA6324	μPC324C	M5224P	
	G1090646	G1090230	G1090757	
Q4026	μPD4001BC	MC14001BCP		
	G1090278	G1090027		
Q4027	μPD4011BC	MC14011BCP		
	G1090282	G1090068		
D4003,4004,4006,4007, 4008,4014,4017,4018, 4019,4022	1SS270	1SS53		
	G2090408	G2090027		
D4023	1SS270TJ	1SS53T1		
	G2060004	G2060002		

◎ 430MHz ALC UNIT

Symbol No.	ORIGINAL
	Part No.
D9601,9602	1SS181 TE85R
	G2070001

◎ 430MHz PLL UNIT

Symbol No.	ORIGINAL
	Part No.
D8004,8005,8006,8007, 8008,8009,8010,8011	1SS270
	G2090408

◎ VOX UNIT

Symbol No.	ORIGINAL	REPLACEMENT	REPLACEMENT	REPLACEMENT
	Part No.	Part No.	Part No.	Part No.
Q9902,9903	2SC2712GR TE85R	2SC1623 L6/L7	2SC2812 L6/L7	2SC2462 LC/LD
	G3327127G	G3316237 F/G	G3328127 F/G	G3324627 C/D

◎ 430MHz SHIFT UNIT

Symbol No.	ORIGINAL
	Part No.
D9201,9202,9203, 9204,9205,9206	2SC2712GR TE85R
	G3327127G

144N
AN

430M
AN

REPLACEMENT	REPLACEMENT	REPLACEMENT
Part No.	Part No.	Part No.
2SC945AP		
G3309451P		

REPLACEMENT	REPLACEMENT	REPLACEMENT
Part No.	Part No.	Part No.
2SA715C		
G3107150C		
2SC945AP		
G3309451P		
1SS53		
G2090027		
1SS53T1		
G2060004		

REPLACEMENT	REPLACEMENT	REPLACEMENT
Part No.	Part No.	Part No.
MC2838-T14-2		
G2070024		

REPLACEMENT	REPLACEMENT	REPLACEMENT
Part No.	Part No.	Part No.
2SC1623 L6/L7	2SC2812 L6/L7	2SC2462 LC/LD
G3316237 F/G	G3328127 F/G	G3324627 C/D

REPLACEMENT	REPLACEMENT	REPLACEMENT
Part No.	Part No.	Part No.
2SA715C		
G3107150C		
2SC945AP		
G3309451P		
1SS53		
G2090027		
1SS53T1		
G2060002		

REPLACEMENT	REPLACEMENT	REPLACEMENT
Part No.	Part No.	Part No.
MC2836-T14-2		
G2070024		

REPLACEMENT	REPLACEMENT	REPLACEMENT
Part No.	Part No.	Part No.
1SS53		
G2090027		

REPLACEMENT	REPLACEMENT	REPLACEMENT
Part No.	Part No.	Part No.
2SC1623 L6/L7	2SC2812 L6/L7	2SC2462 LC/LD
G3316237 F/G	S3328127 F/G	G3324627 C/D

◎ CNTL UNIT

Symbol No.	ORIGINAL	REPLACEMENT	REPLACEMENT	REPLACEMENT
	Part No.	Part No.	Part No.	Part No.
Q1004,1005,1006,1009, 1002,1023,1050	2SC458C	2SC945AP		
	G3304580C	G3309451P		
Q1002	2SC1384R	2SD667C		
	G3313840R	G306670C		
Q1049	BA1A4M	2SC3402		
	G3090074	G3334020		
Q1048	BN1A4M	2SA1348		
	G3090081	G3113480		
Q1007	HM6264ALP-12	HM6264ALP-15	HM6264LP	HM6264ALP-10
	G1090878	G1090879	G1090791	G1090880
Q1035	LA6324	μPC324C	M5224P	
	G1090646	G1090230	G1090757	
Q1030	MC14001BCP	μPD4001-BC		
	G1090027	G1090278		
Q1014	MC14011BCP	μPD4011BC		
	G1090068	G1090282		
Q1013	MC14013BCP	μPD4013BC		
	G1090067	G1090280		
Q1021	MC14066BCP	μPD4066BC		
	G1090257	G1090283		
Q1015	MC14081BCP	μPD4081BC		
	G1090053	G1090658		
Q1003	μPC7805H	L7805		
	G1090299	G1090776		
D1005,1006,1007,1008, 1009,1010,1011,1012	1SS270	1SS53		
	G2090408	G2090027		

◎ DISPLAY UNIT

Symbol No.	ORIGINAL	REPLACEMENT	REPLACEMENT	REPLACEMENT
	Part No.	Part No.	Part No.	Part No.
Q2006	BN1L4M	2SA1345		
	G3090084	G3113450		
Q2010	1SS270	1SS53		
	G2090408	G2090027		

◎ VR C UNIT

Symbol No.	ORIGINAL	REPLACEMENT	REPLACEMENT	REPLACEMENT
	Part No.	Part No.	Part No.	Part No.
D201	1SS270	1SS53		
	G2090408	G2090027		

◎ SW A UNIT

Symbol No.	ORIGINAL	REPLACEMENT	REPLACEMENT	REPLACEMENT
	Part No.	Part No.	Part No.	Part No.
D301	1SS270	1SS53		
	G2090408	G2090027		

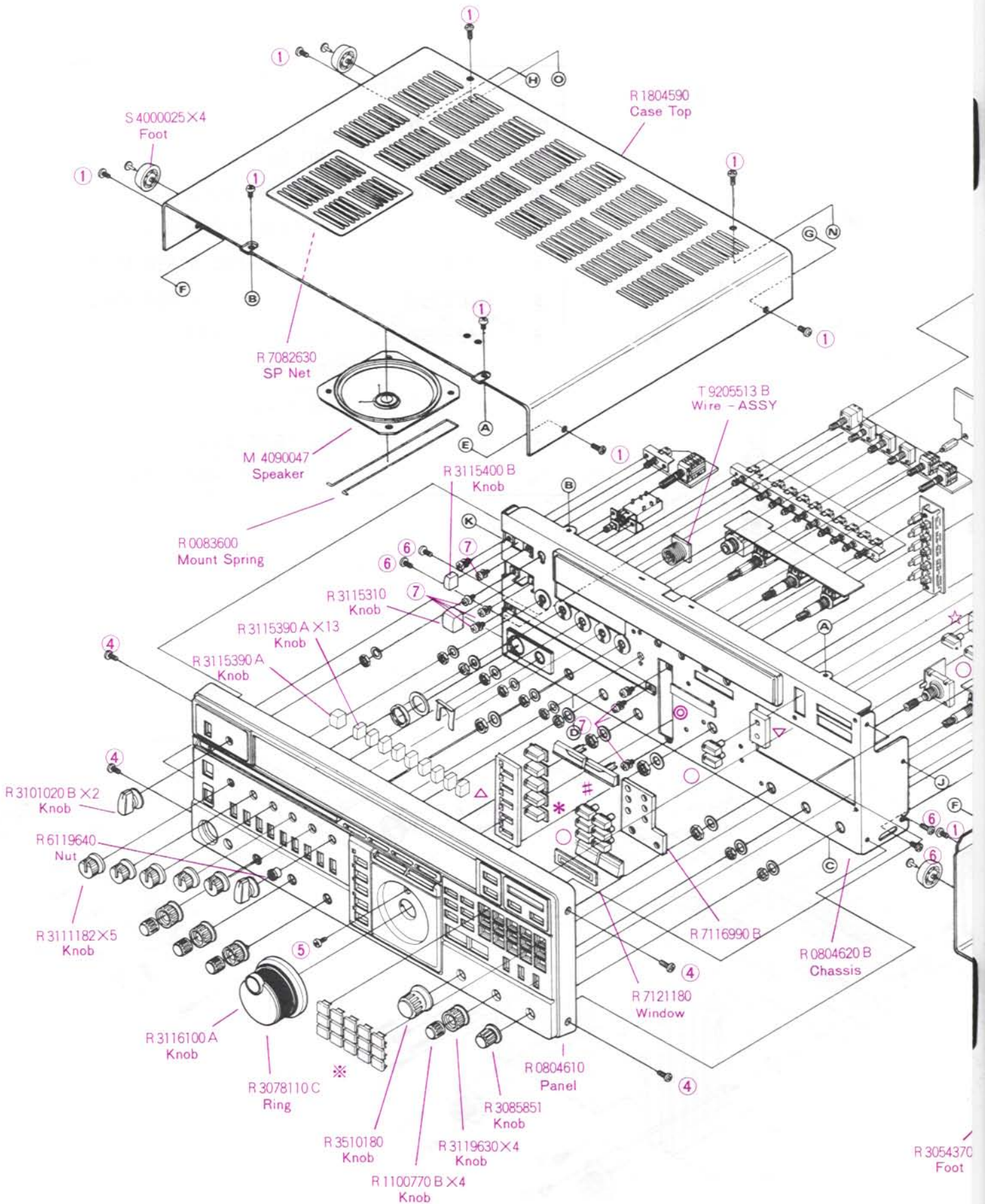

- | | | | | | | | | |
|-----------------|---------------|-----------------|---------------|-------------------|------|----------------------|------|----------------------|
| △ : R 7114200 A | Sponge Rubber | ▽ : R 7116970 B | Sponge Rubber | ○ : R 3116820 X10 | Knob | □ : R 3115340 (U P) | Knob | # : R 3115320 (U P) |
| ◎ : R 7116980 A | Sponge Rubber | ☆ : R 7122620 | Sponge Rubber | * : R 3119630 | Knob | □ : R 3115350 (DOWN) | | # : R 3115330 (DOWN) |

EXPLODED VIEW

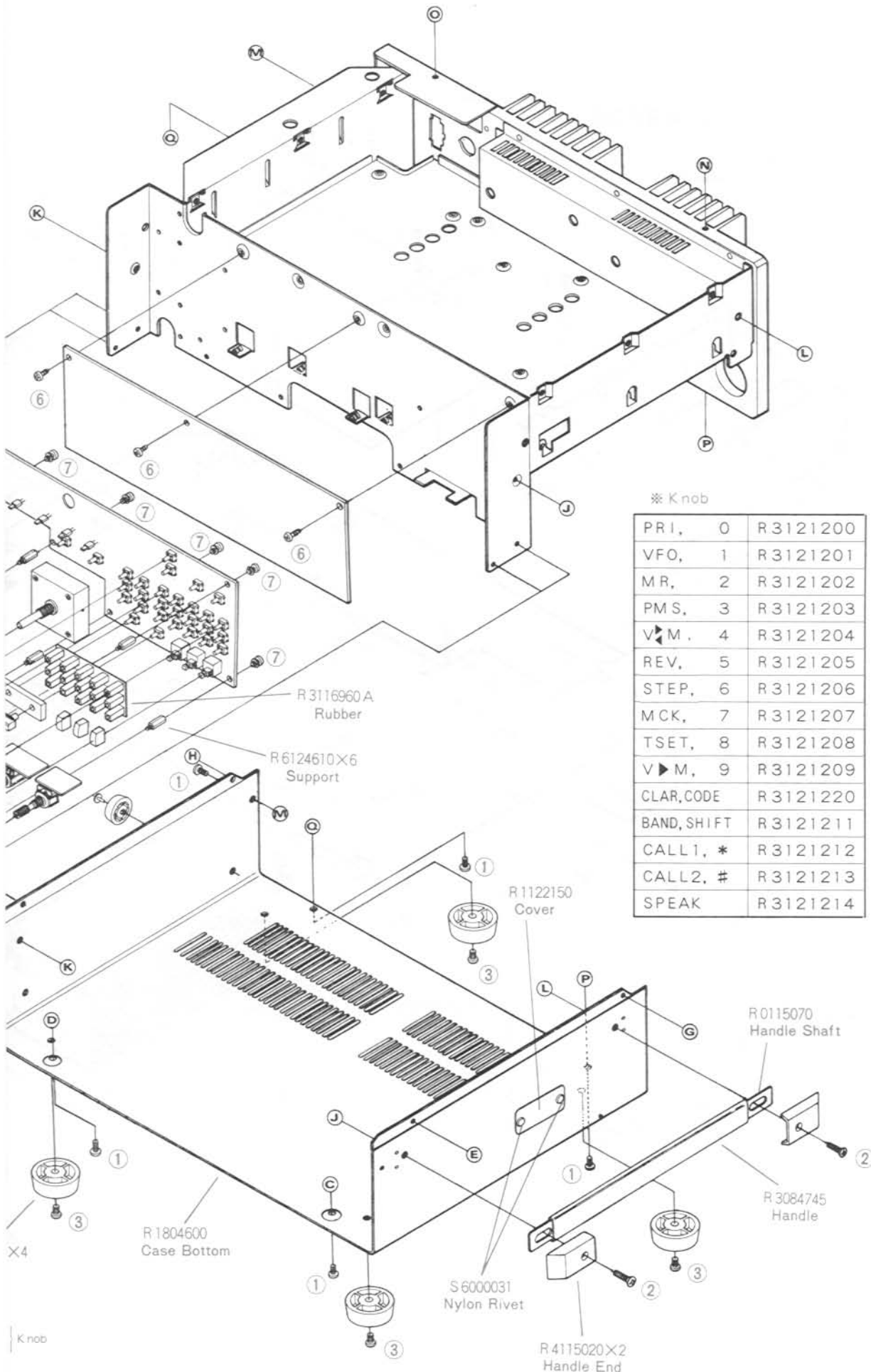

※ Knob

PRI, 0	R 3121200
VFO, 1	R 3121201
MR, 2	R 3121202
PMS, 3	R 3121203
V M, 4	R 3121204
REV, 5	R 3121205
STEP, 6	R 3121206
MCK, 7	R 3121207
TSET, 8	R 3121208
V M, 9	R 3121209
CLAR, CODE	R 3121220
BAND, SHIFT	R 3121211
CALL 1, *	R 3121212
CALL 2, #	R 3121213
SPEAK	R 3121214

X4

Knob

SCREW LIST

Ret No.	Parts No.	Description
①	U20406007	BINDING HEAD SCREW M4X6B
②	U31414002	OVAL HEAD SCREW M4X14 Ni
③	U00406001	PAN HEAD SCREW M4X6
④	U20306007	BINDING HEAD SCREW M3X6B
⑤	U20306001	BINDING HEAD SCREW M3X6
⑥	U42306201	TAPPING SCREW 3 ϕ X6
⑦	U02306001	SEMS SCREW SM3X6
⑧	U00306001	PAN HEAD SCREW M3X6
⑨	U00314001	PAN HEAD SCREW M3X14
⑩	U40308201	TAPPING SCREW 3 ϕ X8

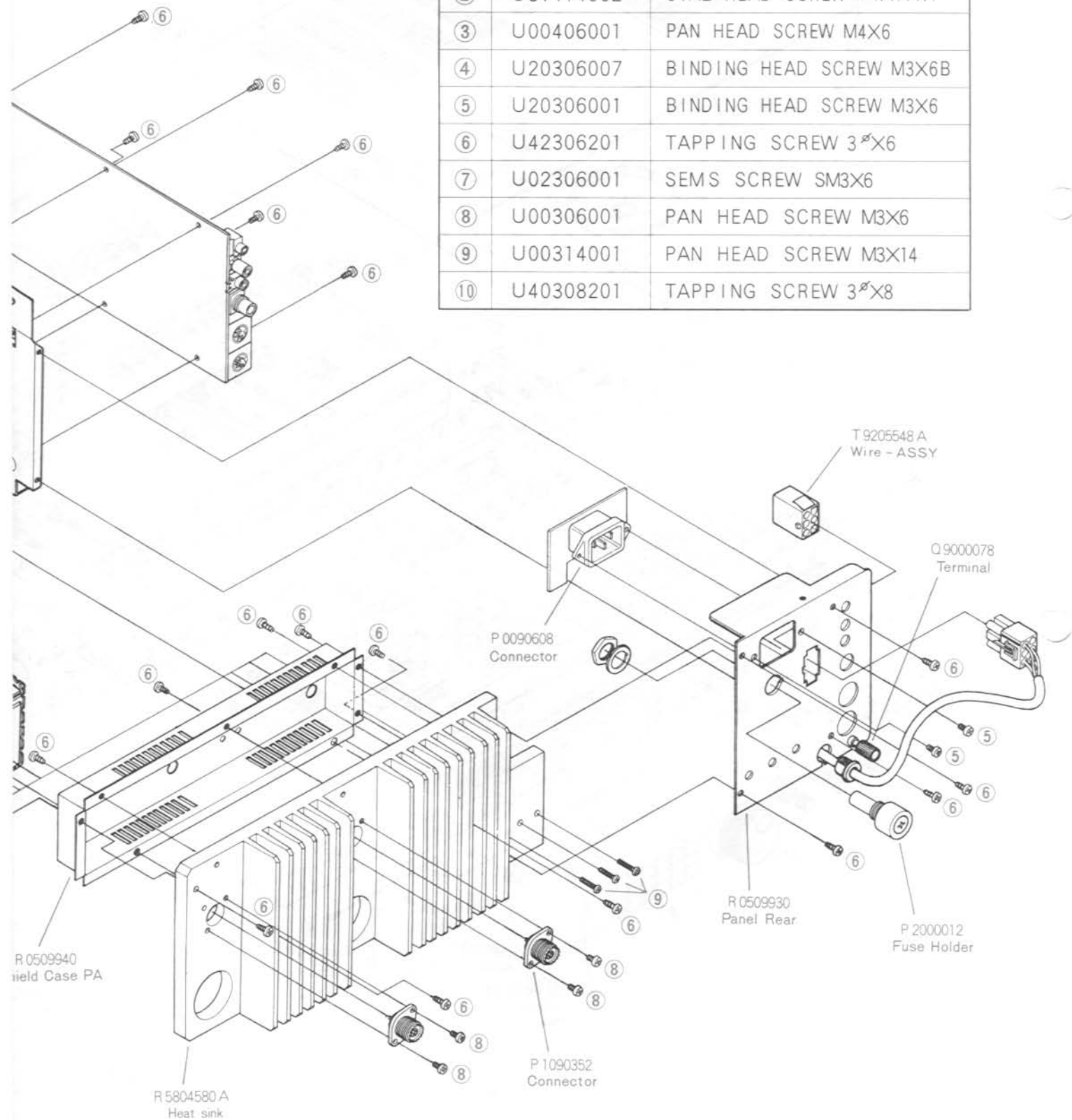

50MHz PLL UNIT (No. 1XXX)

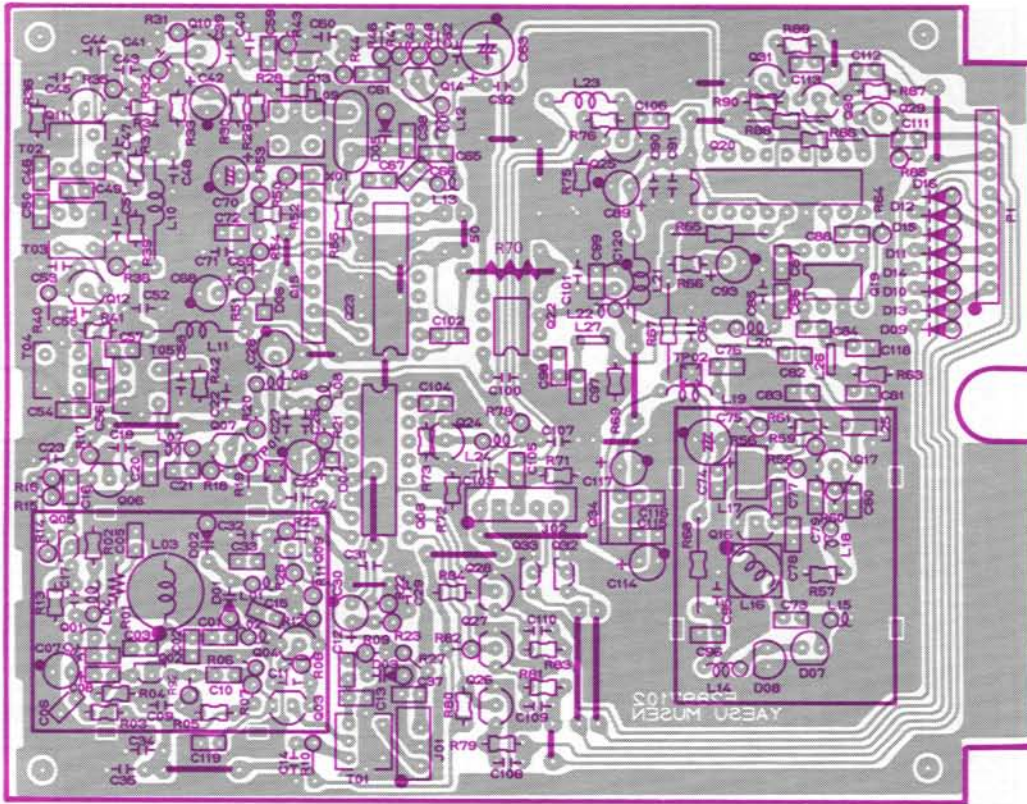

Component side (obverse)

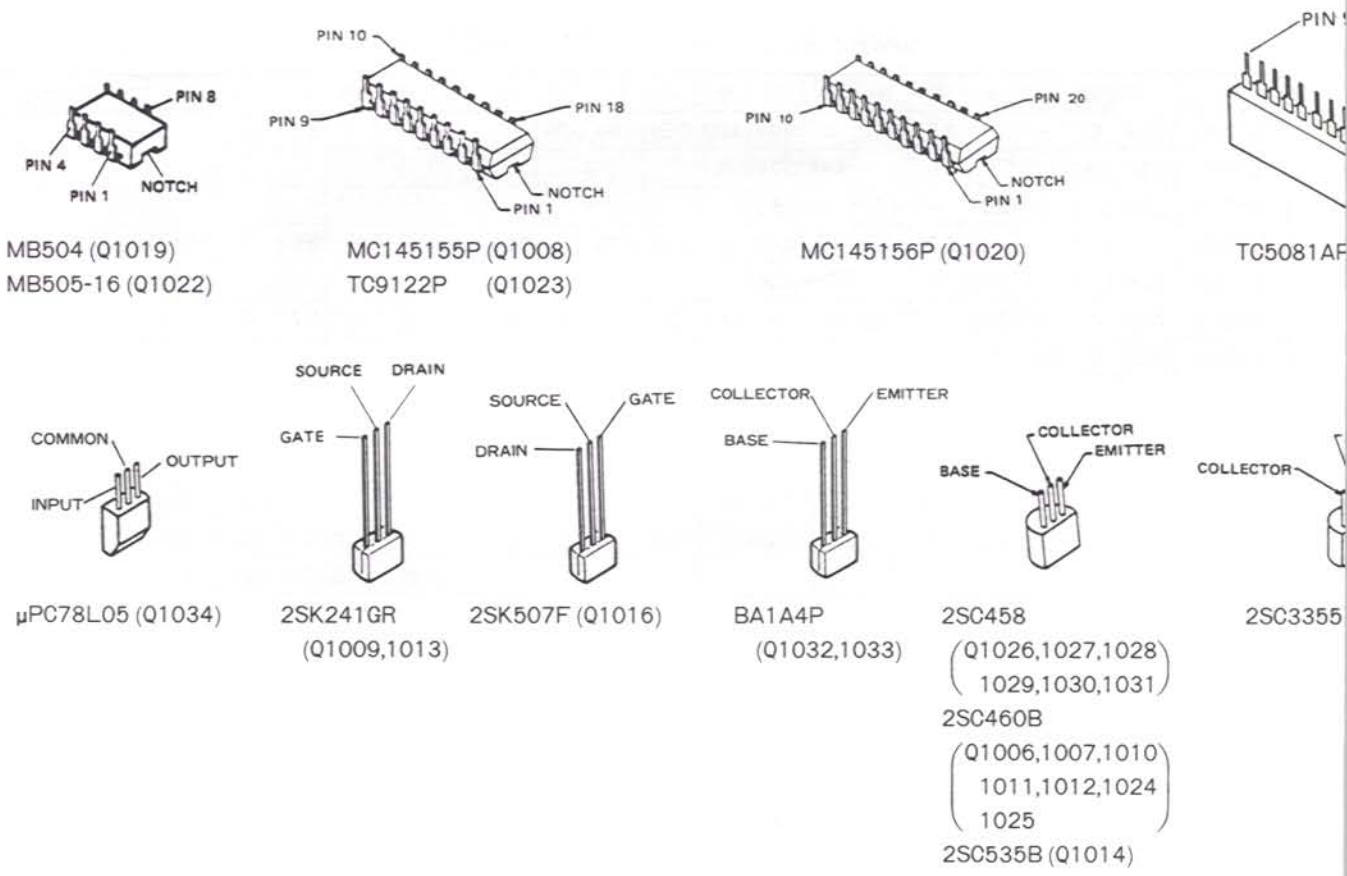

0MHz BAND MODULE (FEX-736-50) OPTION

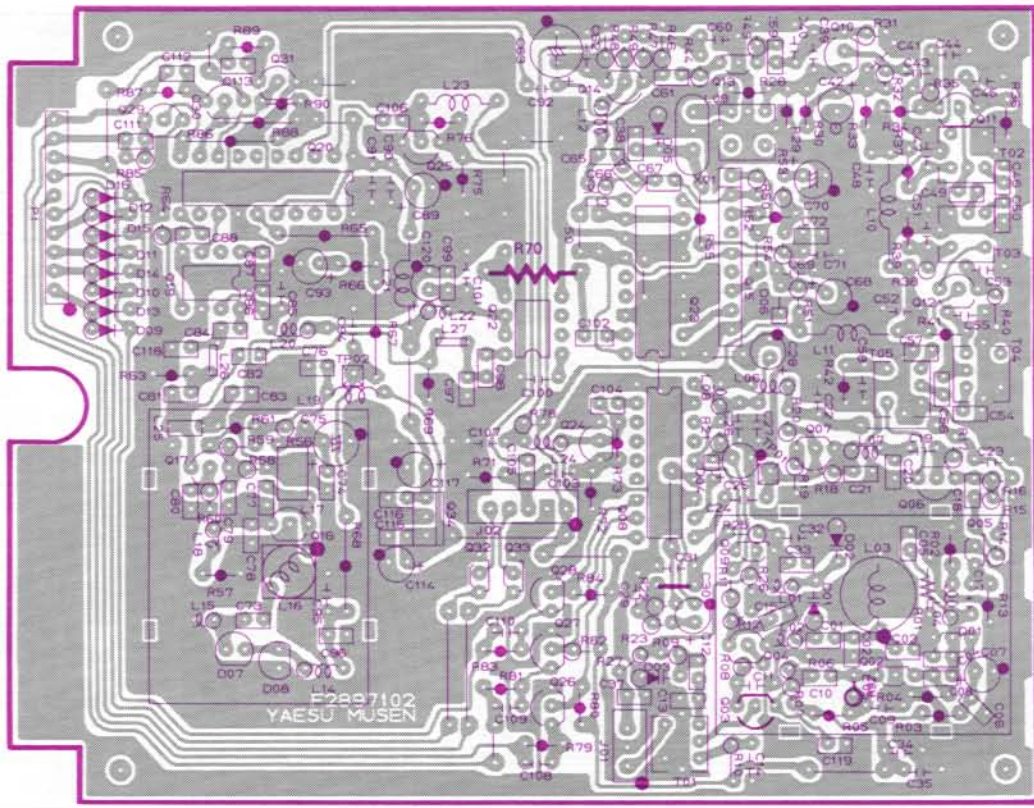

Component side (reverse)

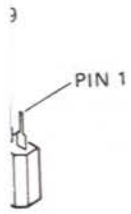

(Q1015)

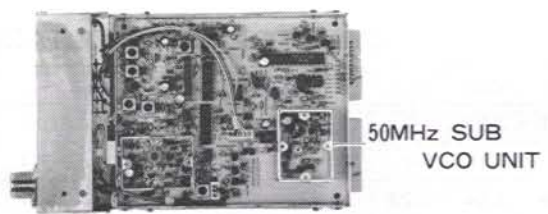

50MHz SUB VCO UNIT (No. 1XXX)

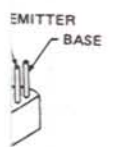

(Q1017)

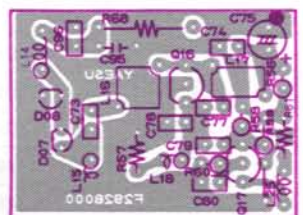

Component side (obverse)

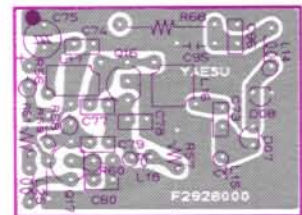

Component side (reverse)

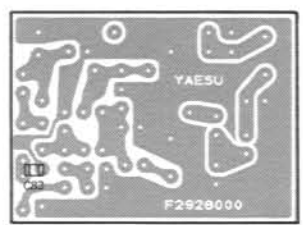

Chip side (obverse)

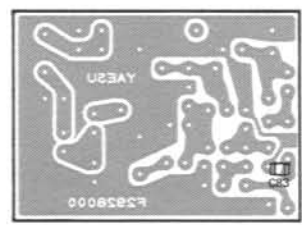

Chip side (reverse)

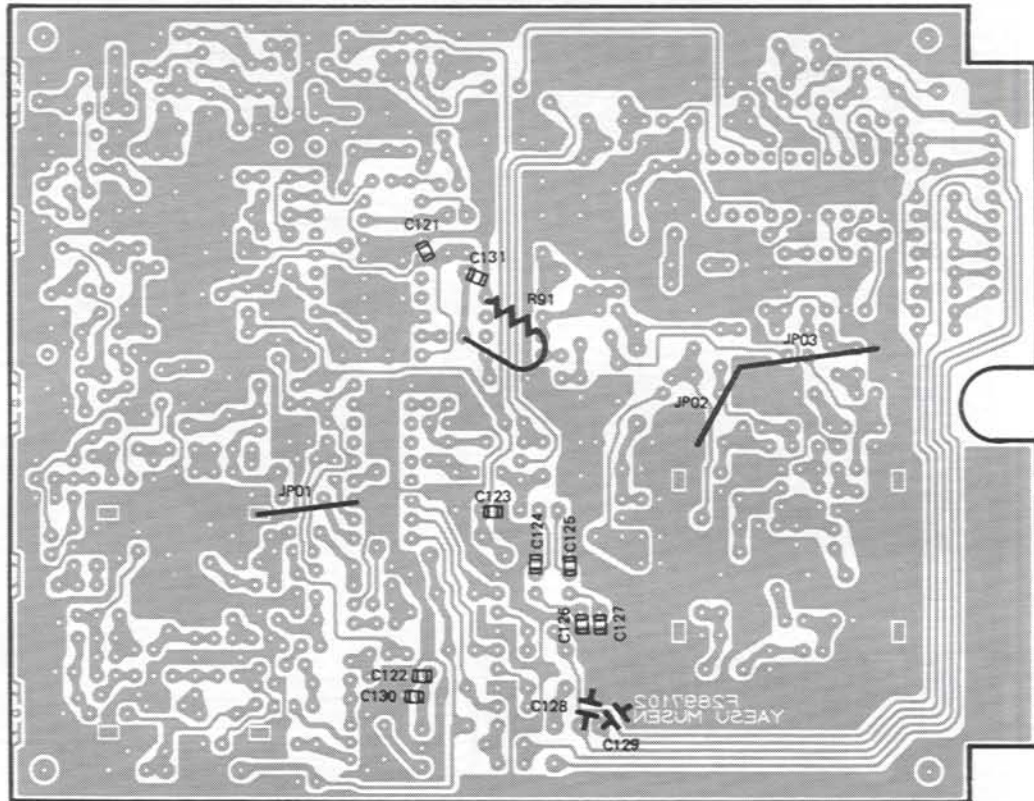

Solder side (reverse)

50MHz PLL UNIT IC VOLTAGE CHART

(DC VOLTS)

	1 (IN)	2 (OUT)	3 (GND)	4	5	6	7	8	9	10	11	12	13	14	15	16	17	18	19	20	REMARKS	
Q1008	8.57	0	—	—	8.56	5.22	0	8.49	3.92	0.09	0.09	0.09	—	—	—	—	3.97	0				
Q1015	3.32	3.30	2.78	—	7.57	—	3.32	0.79	0													
Q1019	2.53	5.02	0	2.91	—	4.45	—	2.52														
Q1020	0	5.02	—	—	5.03	1.62	0	4.45	—	1.98	0.72	0.07	0.06	0.03	—	—	2.53	—	2.04	5.03		
Q1022	2.46	5.03	5.03	2.70	0	—	—	2.46														
Q1023	7.56	3.11	0	0.02	0.02	7.56	0	0	7.56	0	0	0	0	0	0	0	0.79	0				
Q1034	9.00	0	5.01																			

TO : SMC LTD

YMF-00730 / 27

ATTN : MR. GRAHAM TYLAR

RE : MODIFICATION FOR POWER ON UNLOCK WITH 50MHZ UNIT IN FT-736R

INSTALL A 2.2 K-OHMS RESISTOR BETWEEN THE JUNCTION OF T04, R41 AND C55,
AND THE COLLECTOR OF Q12 ON THE PLL UNIT.

AFTER ABOVE MODIFICATION, ADJUST THE CORE OF T02 TO T05 FOR THE
MAIXIMUM LEVEL.

PLEASE REFER TO THE FOLLOWING FAX.

BEST REGARDS,

YAESU MUSEN CO., LTD.

T. TANAKA

50MHz PLL UNIT F2897102 (No.1xxx)

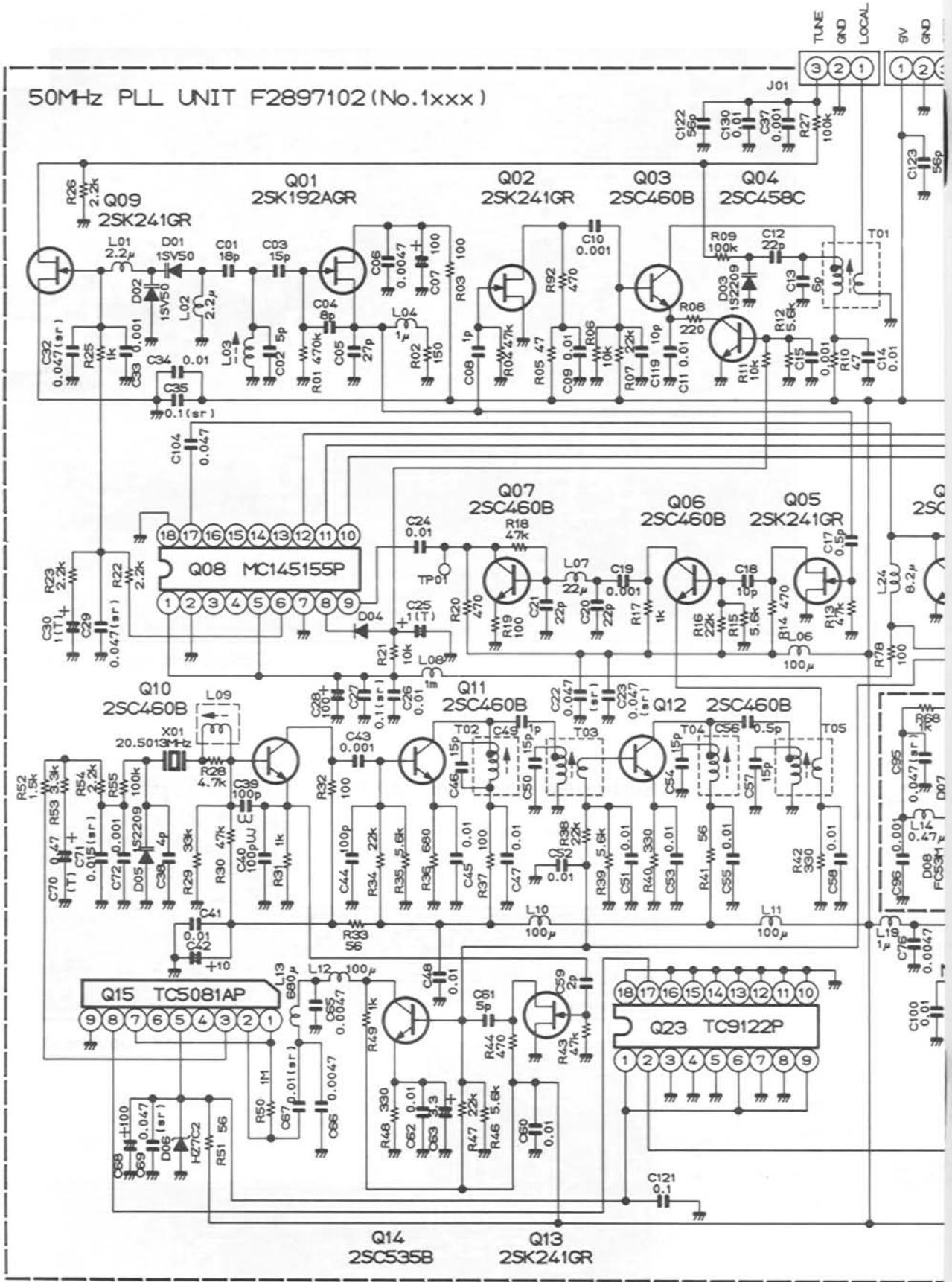

RFSISTOR VALUES ARE IN Ω, 1/5W;
 CAPACITOR VALUES ARE IN μF.
 INDUCTOR VALUES ARE IN HENRIES, UNLESS OTHERWISE NOTED.

0MHz BAND MODULE (FEX-736-50) OPTION

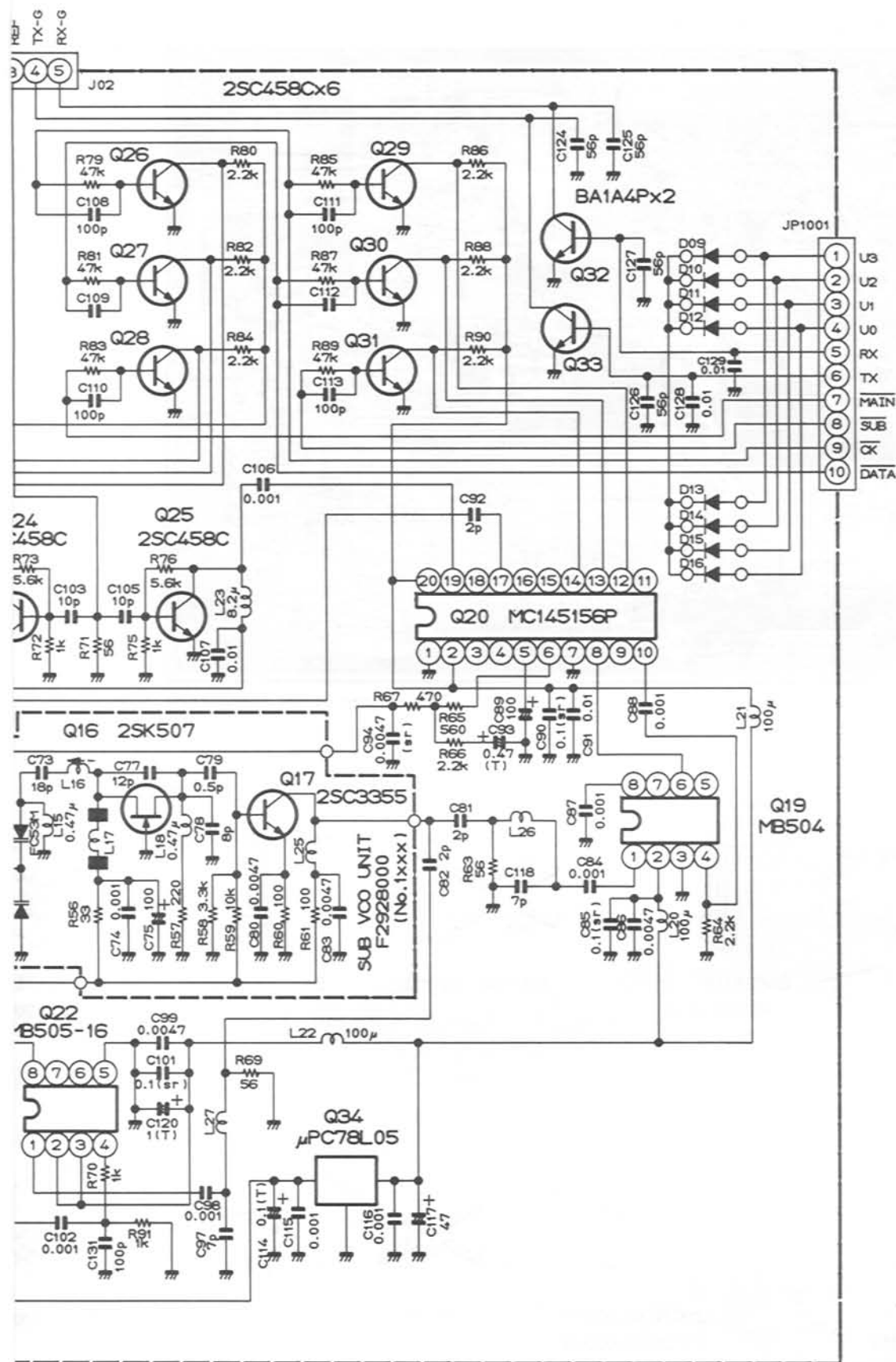

DIODES ARE TYPE 1SS270 UNLESS OTHERWISE NOTED.
 (T) CAPACITORS ARE TANTALUM.
 (sr) CAPACITORS ARE SEMICONDUCTOR CERAMIC, 25Vv:

50MHz BAND MODULE (FEX-736-50) OPTIO

50MHz RF UNIT (No. 2XXX)

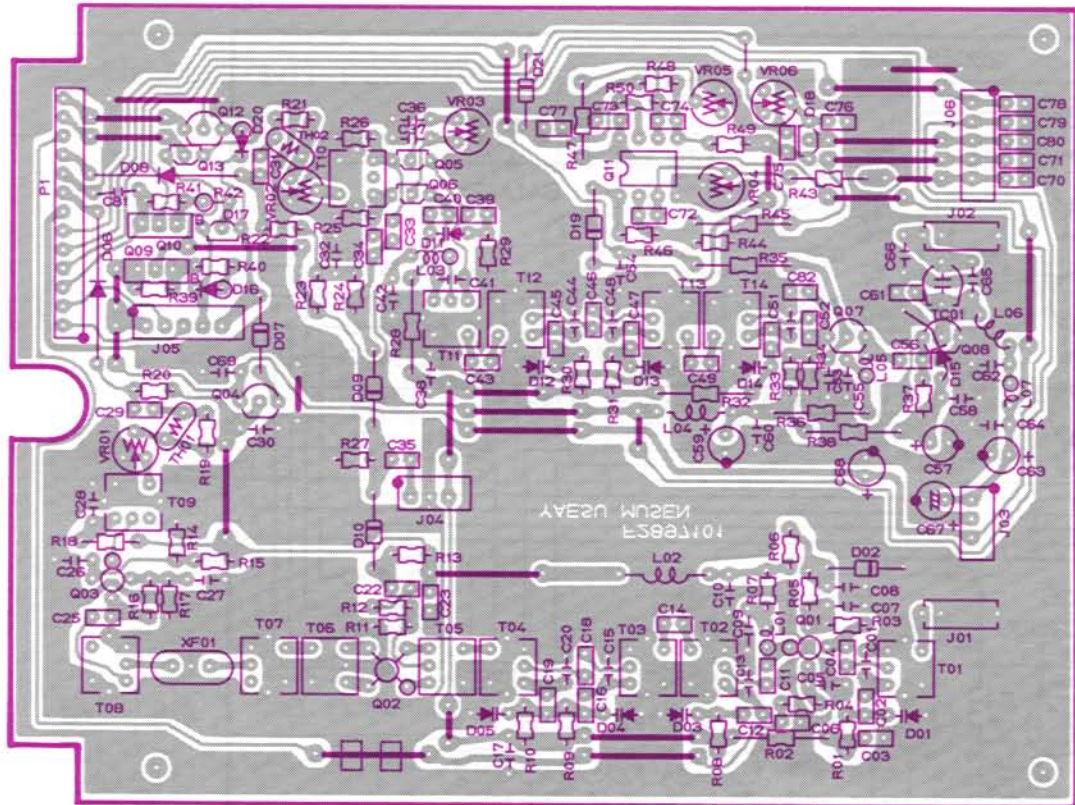

Component side (obverse)

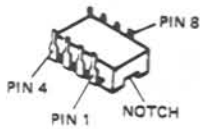

LA6358 (Q2011)

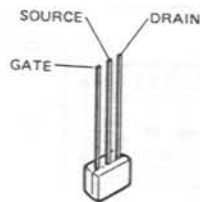

2SK241GR
(Q2004,2005)

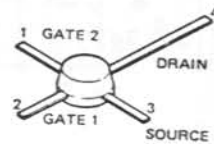

3SK122L (Q2003)

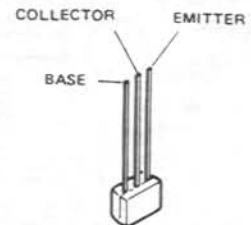

BA1A4P (Q2013)

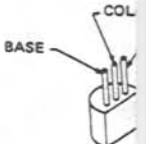

2SA15
(Q20)

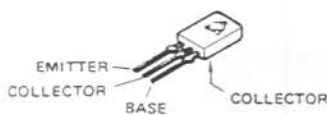

2SB772Q
(Q2009,2010)

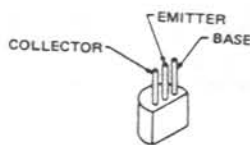

2SC2026 (Q2007)
2SC2538 (Q2008)

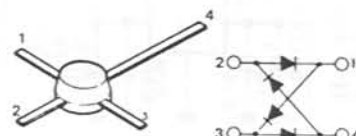

ND487C1-3R (Q2002)

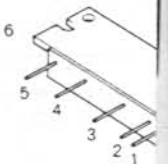

M57735 (Q)

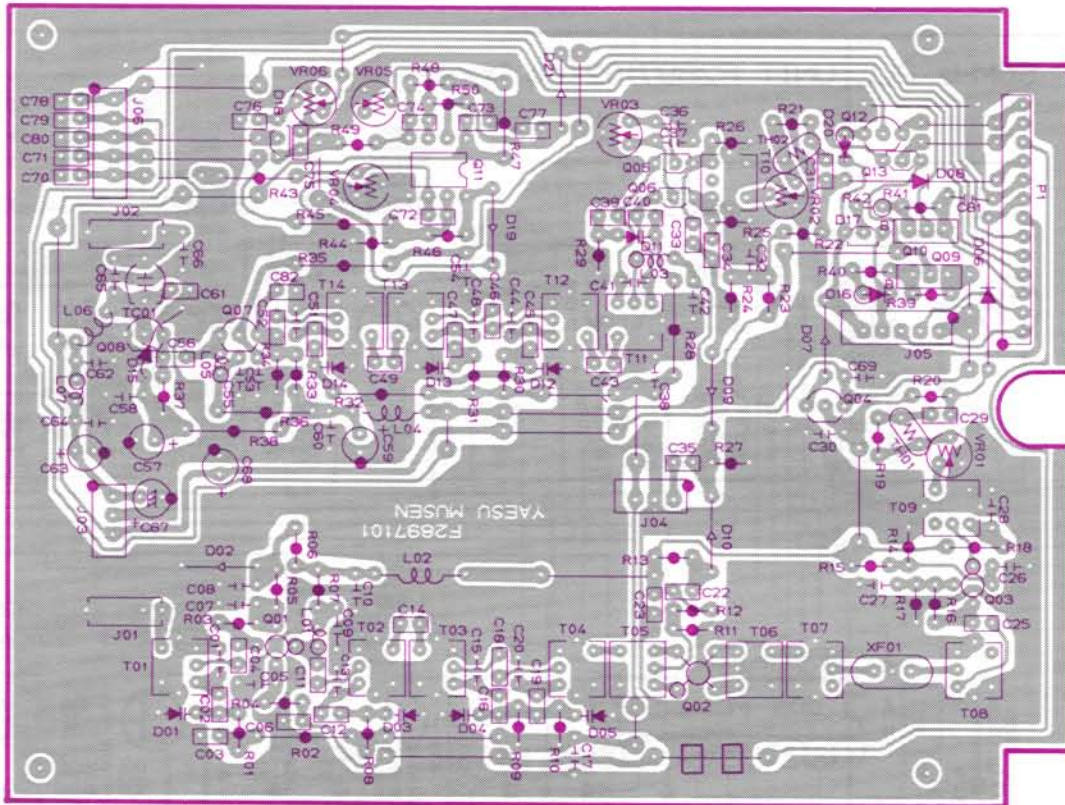

Component side (reverse)

50MHz PA UNIT (No. 3XXX)

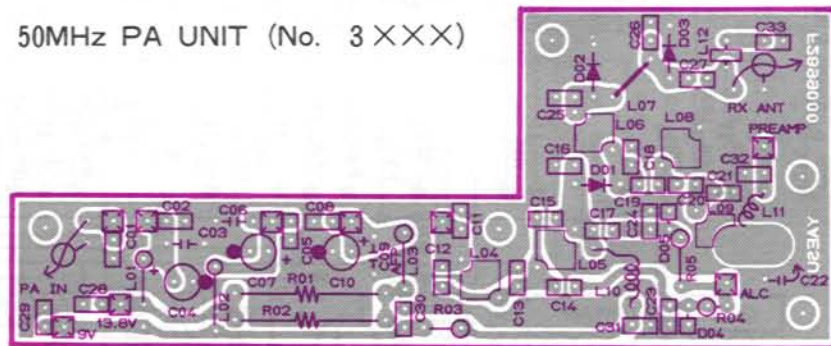

Component side (obverse)

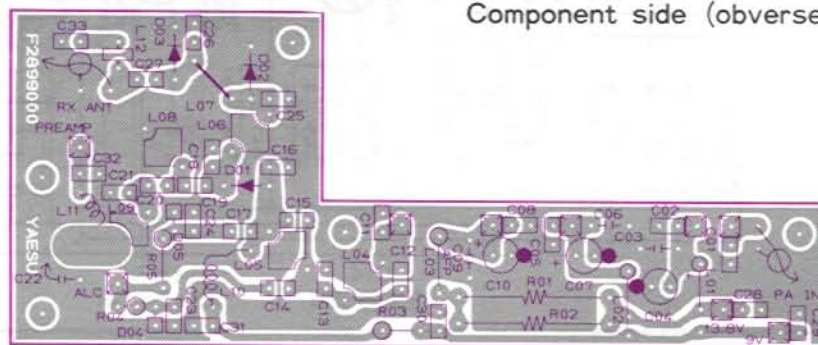

Component side (reverse)

1. INPUT
2. Vcc₁
3. Vcc₂
4. Vcc₃
5. OUTPUT
6. FLA

LECTOR
EMITTER

28
04,2012)

3001)

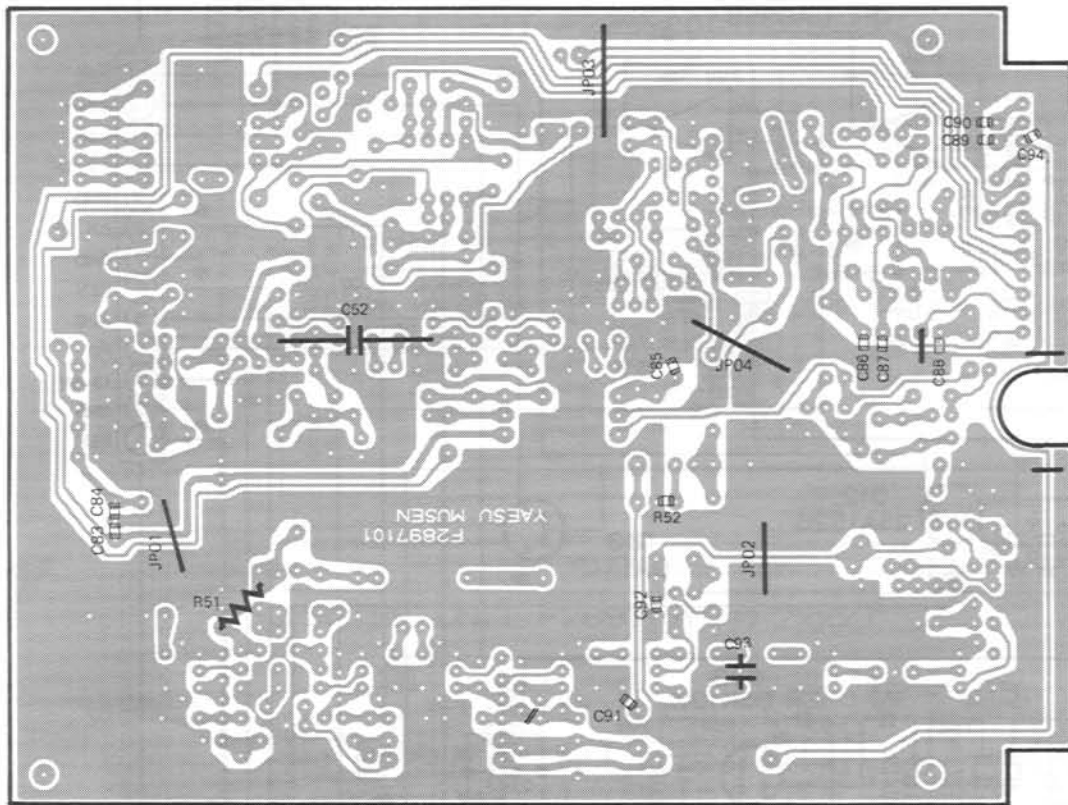

Solder side (obverse)

50MHz RF UNIT VOLTAGE CHART
(DC VOLTS)

	E(S)	C(D)	(G ₁) ^B	(G ₂)	REMARKS
Q2001	1.24	8.50	1.07	1.99	
Q2003	0.61	8.34	0.61	4.44	
Q2004	9.00	8.93/0.02	8.80/8.96		RX/TX
Q2005	0.95	8.94	0.05		
Q2006	0.95	8.94	0.05		
Q2007	1.71	8.78	2.47		
Q2008	0	13.04	0.64		
Q2009	8.98	0/8.90	8.89/8.22		RX/TX
Q2010	13.80	13.42/13.19	12.80/12.62		RX/TX
Q2012	0/12.50	0/12.50	0/0.79		PRE AMP OFF/ON
Q2013	0	0	0/8.90		RX/TX

	1(IN)	2(OUT)
Q2002	0	0
Q2011	8.67	6.14
Q3001	—	13.8
Q01	13.50	0

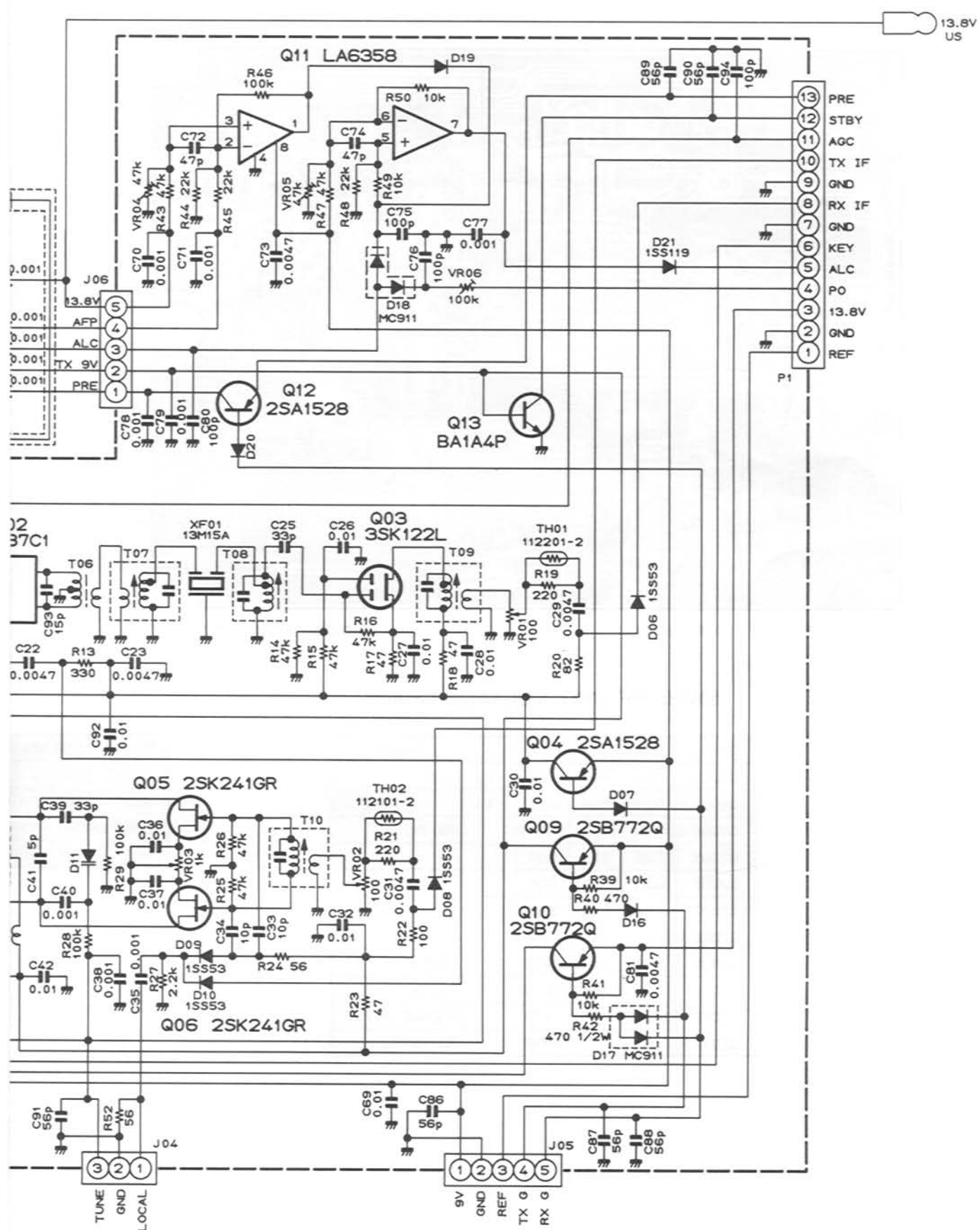

220MHz RF UNIT (No. 2XXX)

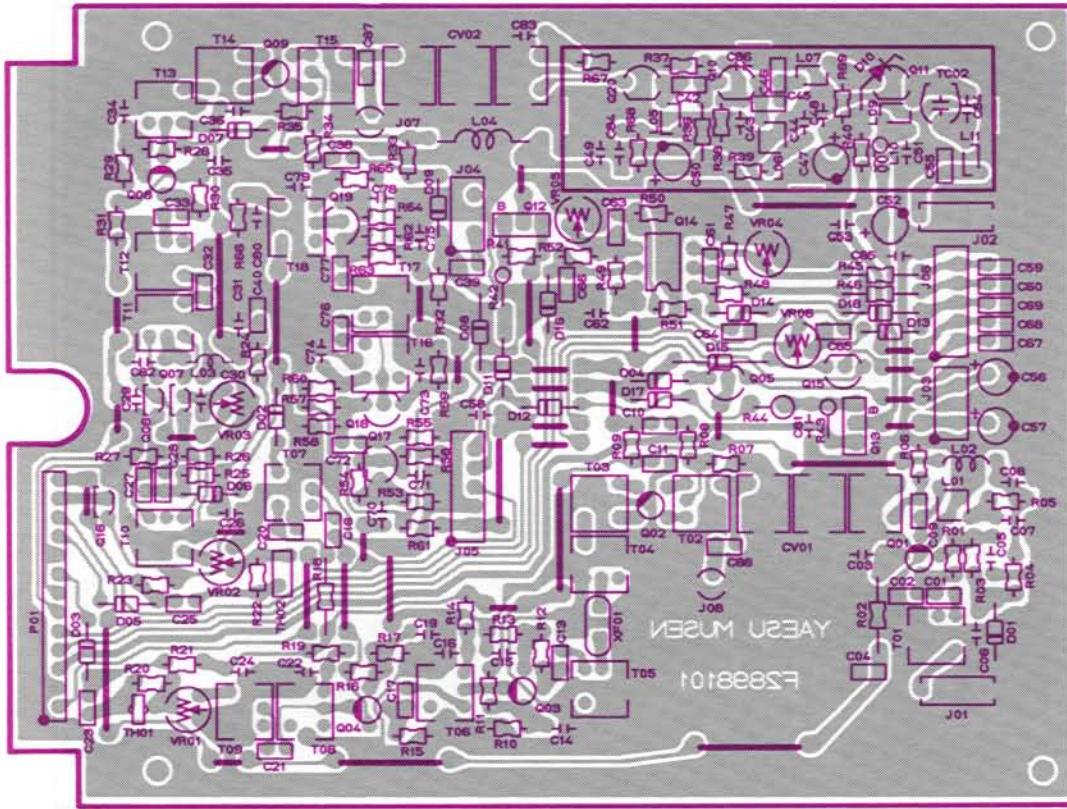

Component side (obverse)

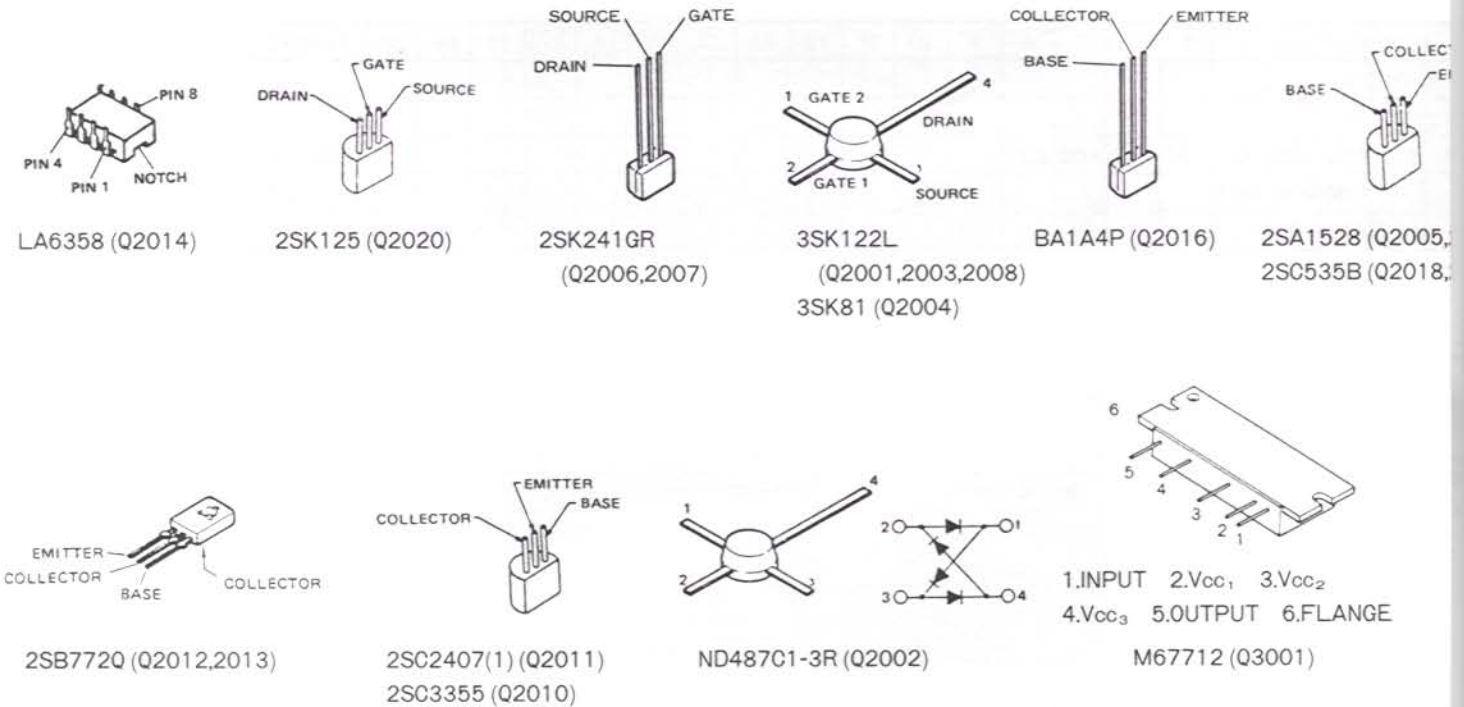

20MHz BAND MODULE (FEX-736-220) OPTION

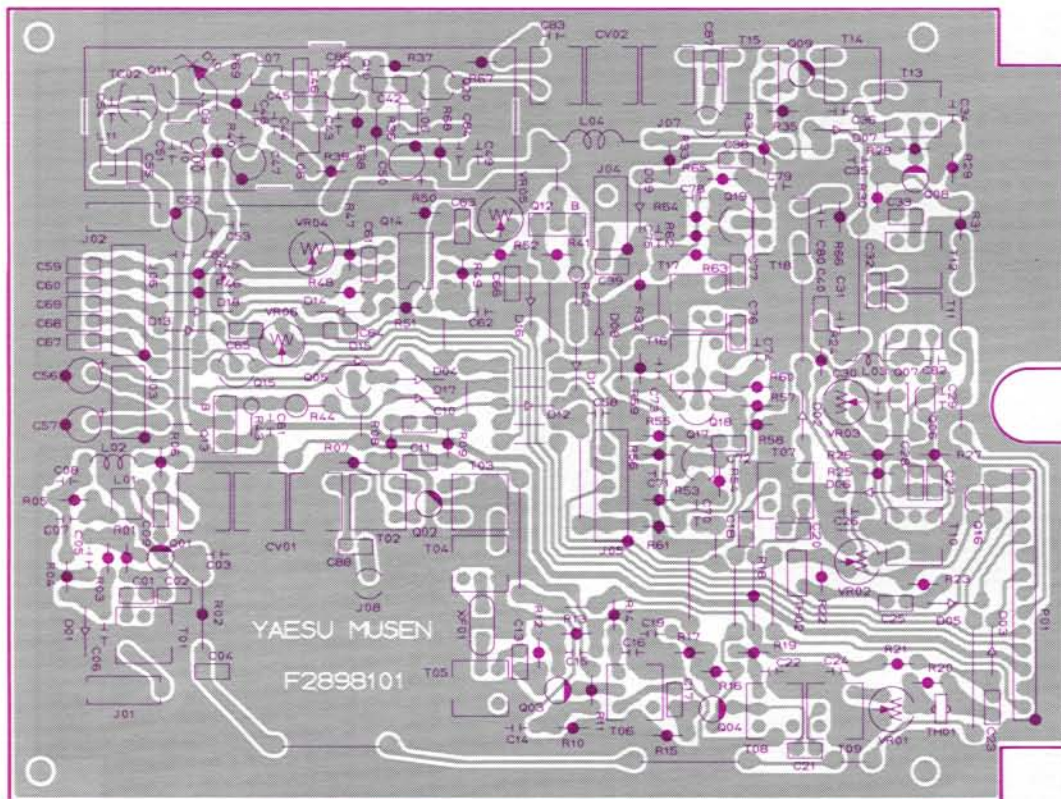

Component side (reverse)

220MHz PA UNIT (No. 3XXX)

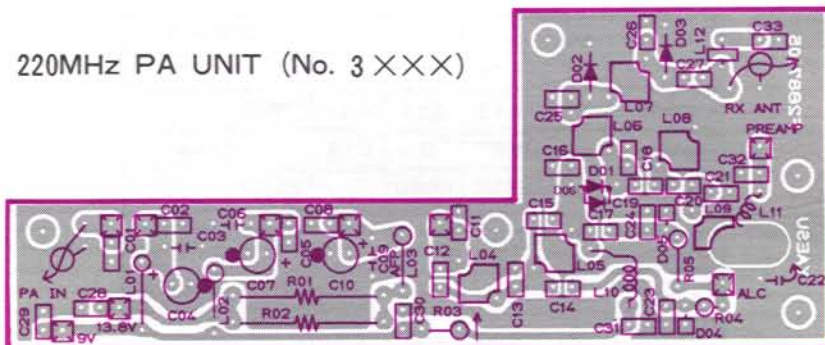

Component side (obverse)

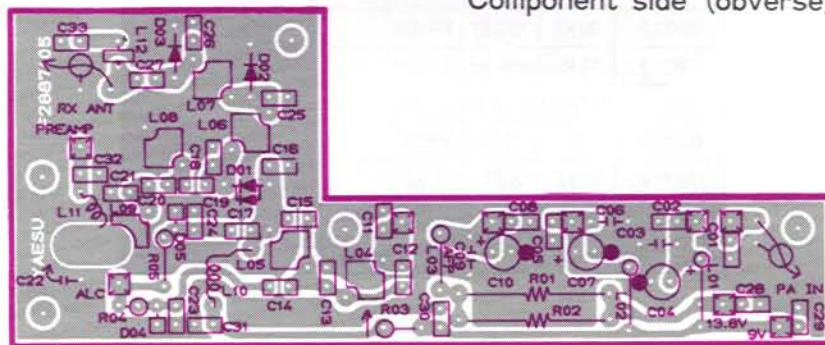

Component side (reverse)

FOR
MITTER

2015)
2019)

220MHz BAND MODULE (FEX-736-220) OPTIO

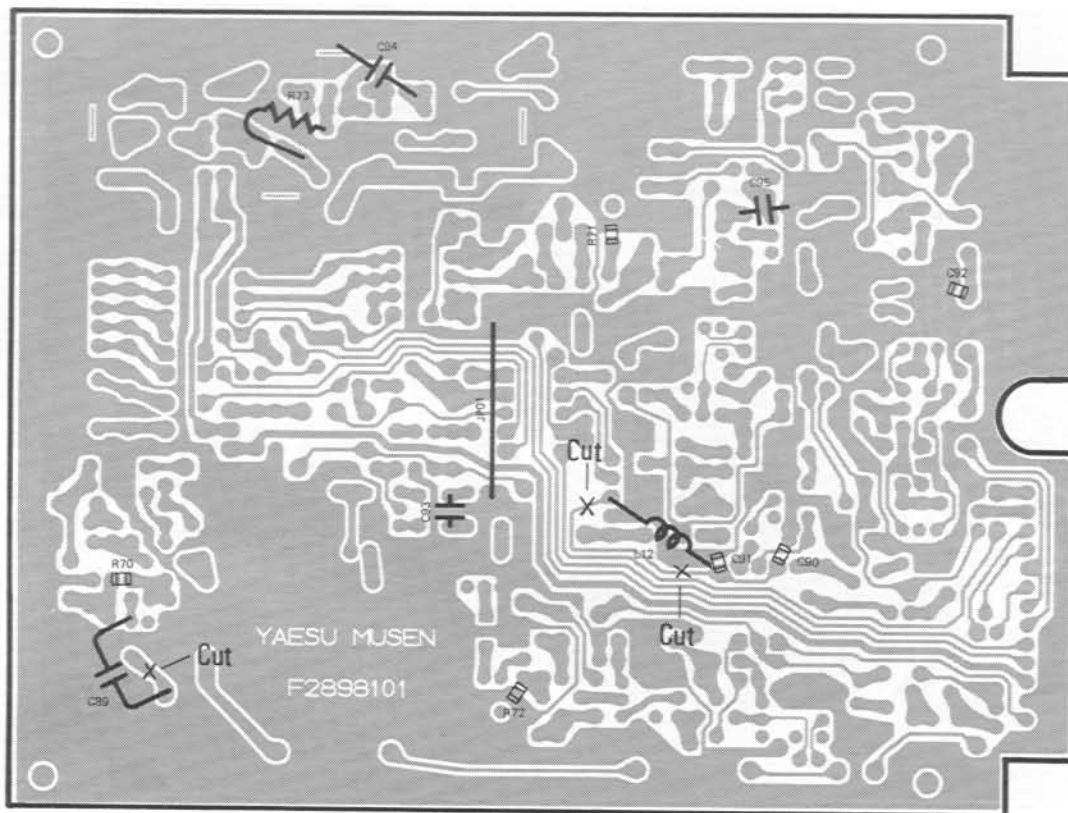

Solder side (obverse)

220MHz RF UNIT VOLTAGE CHART

(DC VOLTS)

	E(S)	C(D)	(G ₁) ^B	(G ₂)	REMARKS
Q2001	1.02	8.64	0.92	1.99	
Q2003	0.50	8.43	0.33	4.47	
Q2004	0.28	8.67	0	0.19	
Q2005	9.00	8.95/0	0.79/8.89		RX/TX
Q2006	1.0	8.9	0		
Q2007	1.0	8.9	0		
Q2008	1.69	8.18	1.82	5.21	
Q2010	0.81	8.55	1.55		
Q2011	0	12.56	0.47		
Q2012	9.00	0/8.91	8.99/8.20		RX/TX
Q2013	13.80	13.44/12.85	12.72/12.16		RX/TX
Q2015	0/12.50	0/12.50	0/0.79		PRE AMP OFF/ON
Q2016	0	0.23/0	0/8.53		RX/TX
Q2018	0.97	8.76	1.52		
Q2019	1.34	8.73	2.00		
Q2020	1.28	7.65	0		

Q2002
Q2009
Q2014
Q3001
001

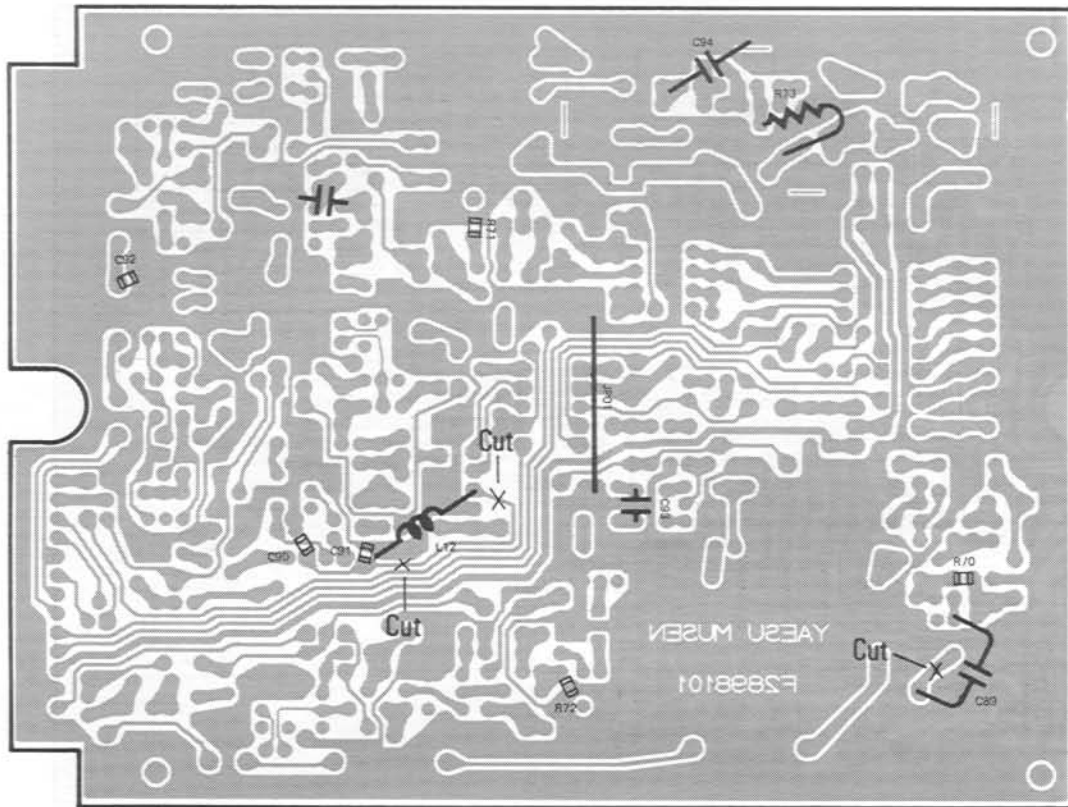

Solder side (reverse)

220MHz RF UNIT IC VOLTAGE CHART

(DC VOLTS)

1 (IN)	2 (OUT)	3 (GND)	4	5	6	7	8	9	10	11	12	13	14	15	16	17	18	19	20	REMARKS
0	0																			
0	0																			
1.19	6.02	6.02	0	1.57	1.57	1.06	8.97													@ 10W output
-	13.80	9.00	13.16	-																@ 10W output
13.8	8.0	0																		

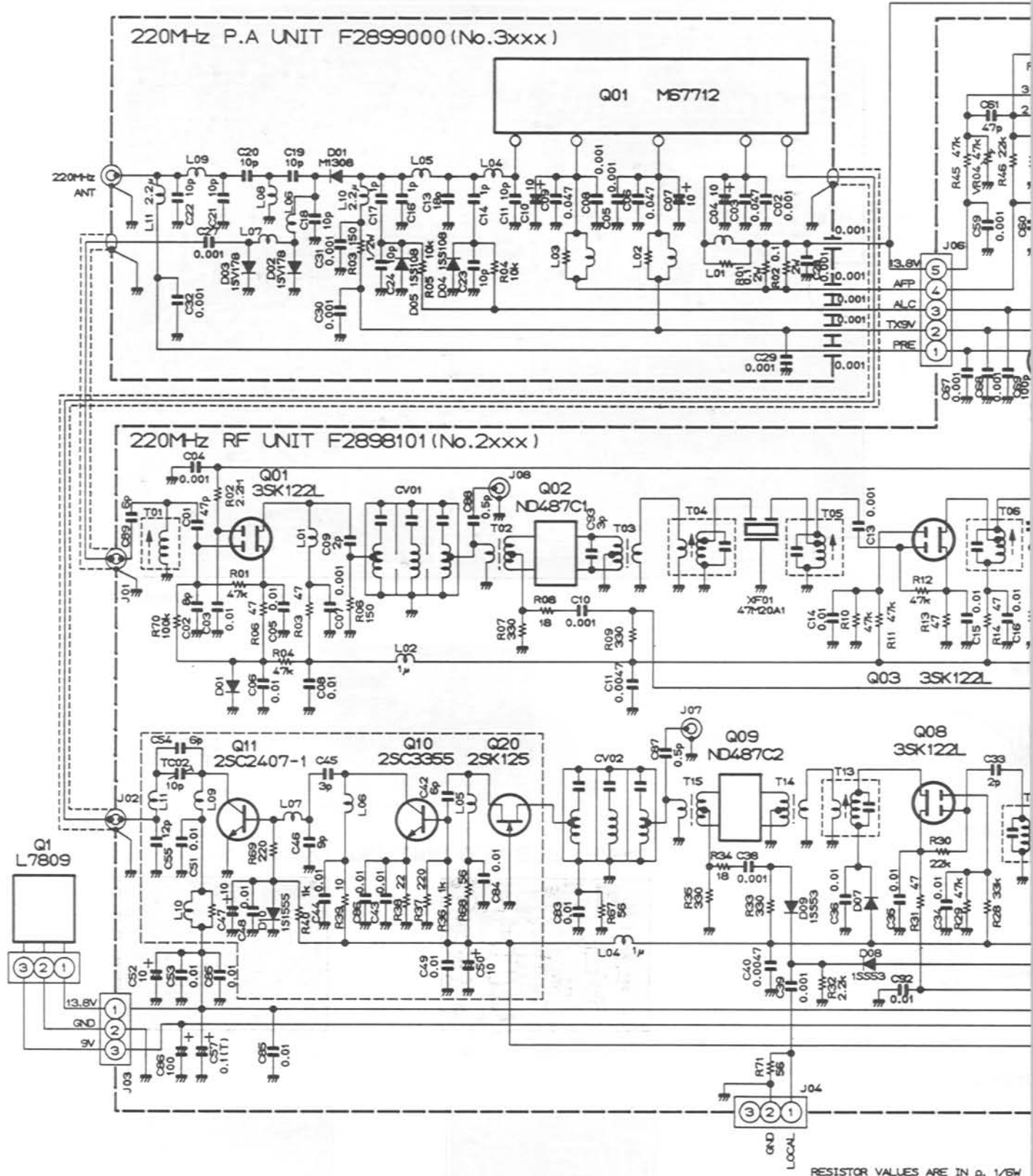

20MHz BAND MODULE(FEX-736-220) OPTION

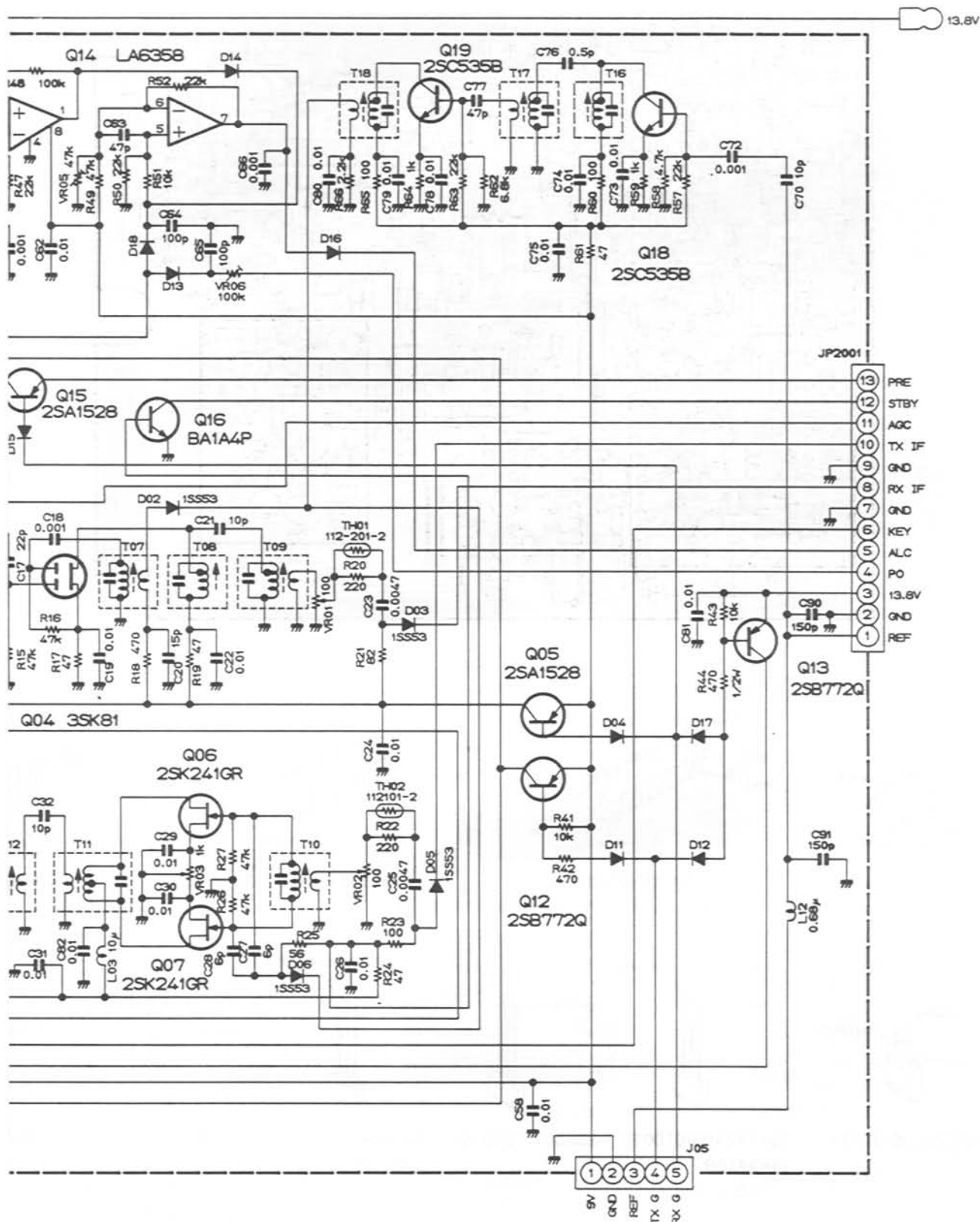

DIODES ARE TYPE 1SS270 UNLESS OTHERWISE NOTED.

(T) CAPACITORS ARE TANTALUM.

(#) CAPACITORS ARE SEMICONDUCTOR CERAMIC. 25V:

UNLESS OTHERWISE NOTED.

220MHz BAND MODULE (FEX-736-220) OPTION

220MHz PLL UNIT (No. XXX)

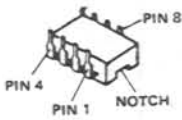
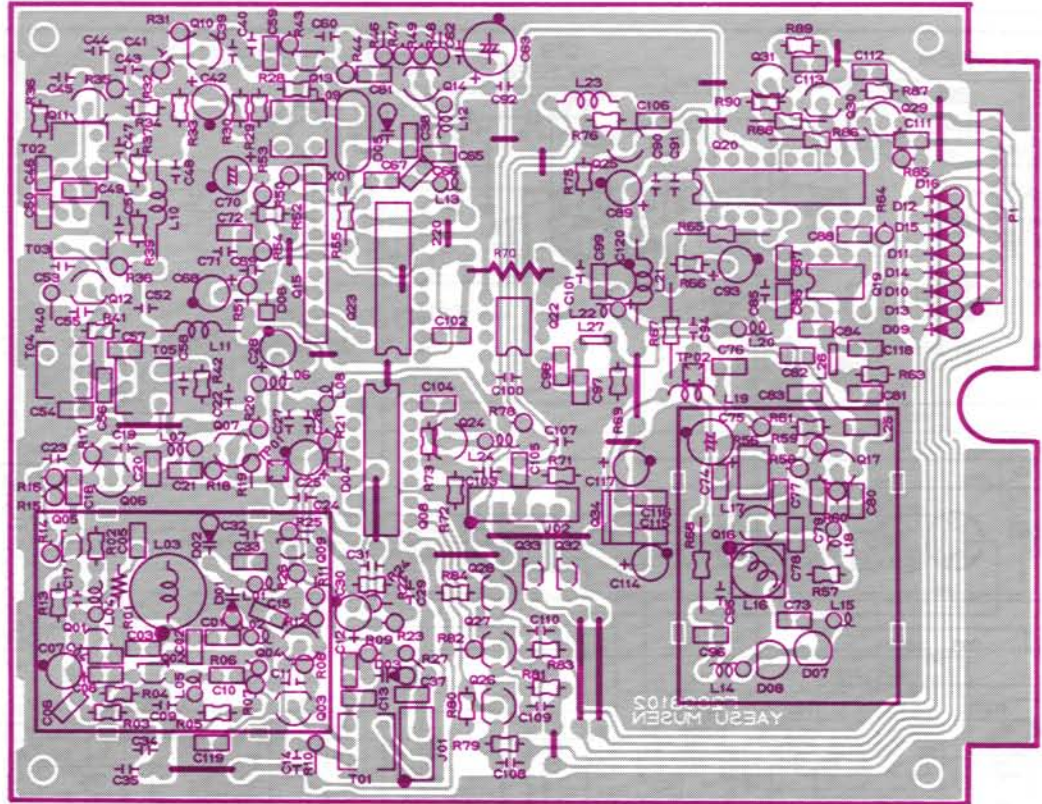

MB504(Q1019)
MB505-16(Q1022)

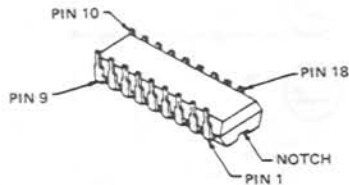

TC9122P(Q1023)
MC145155P(Q1008)

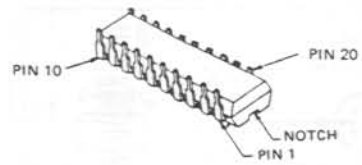

MC145156P(Q1020)

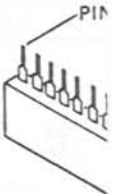

TC5081

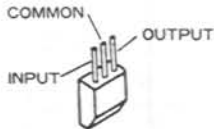

μPC78L05(Q1034)

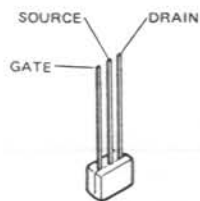

2SK192AGR(Q1001)
2SK241GR
(Q1002,1005,1013)

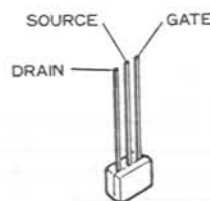

2SK507F(Q1016)

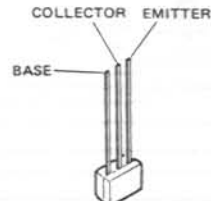

BA1A4P
(Q1032,1033)

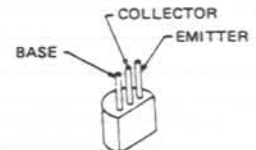

2SC458C
(Q1004,1024,1025)
1026,1027,1028
1029,1030,1031
2SC460B
(Q1007,1010)
2SC535B
(Q1003,1006,1011)
1012,1014

2SC

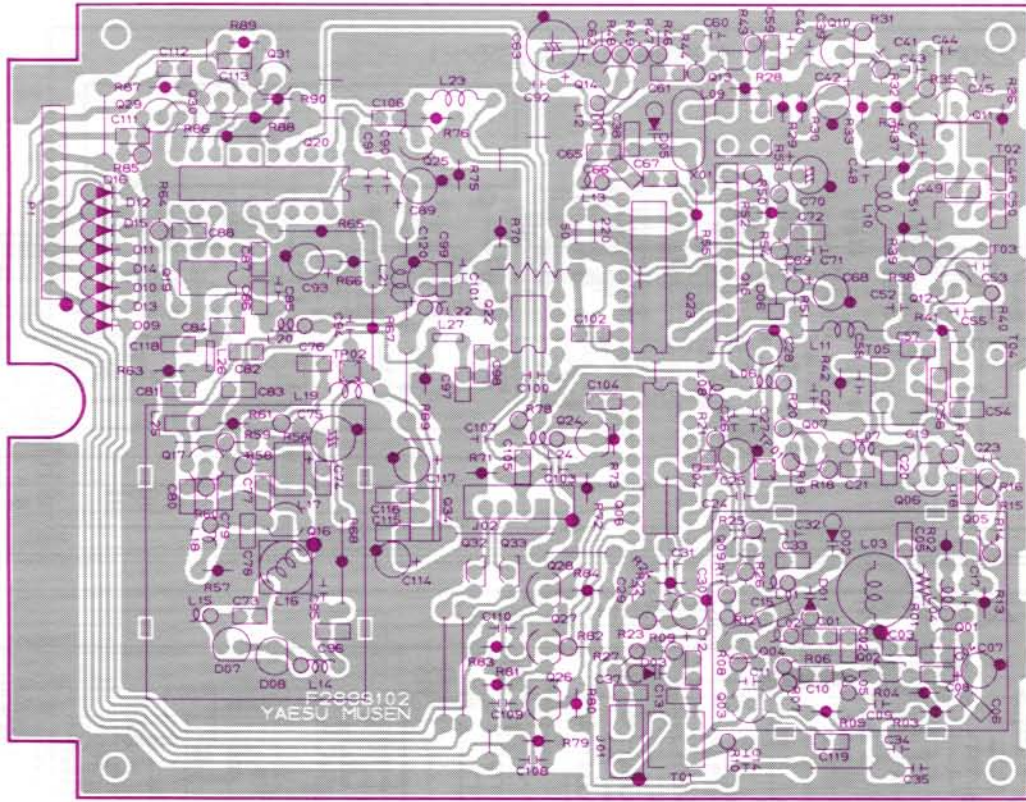

Component side (reverse)

19

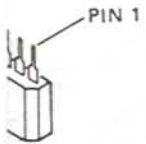

AP(Q1015)

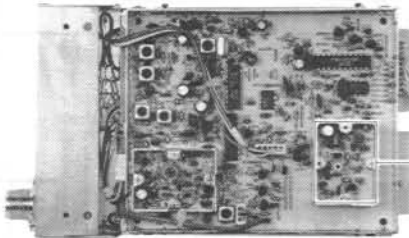

220MHz SUB VCO UNIT

220MHz SUB VCO UNIT (No. 1XXX)

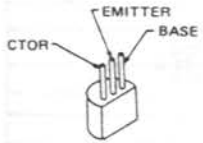

33355(Q1017)

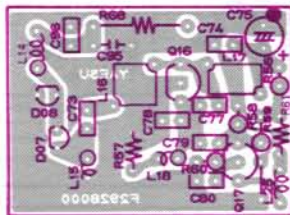

Component side (obverse)

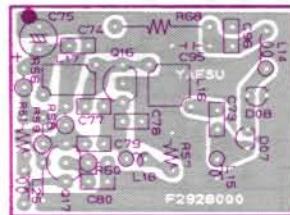

Component side (reverse)

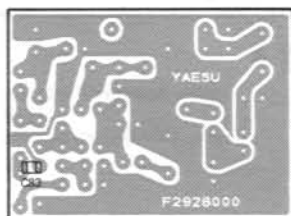

Solder side (obverse)

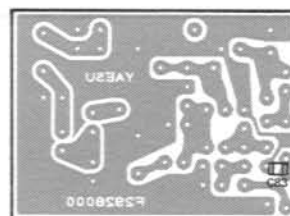

Solder side (reverse)

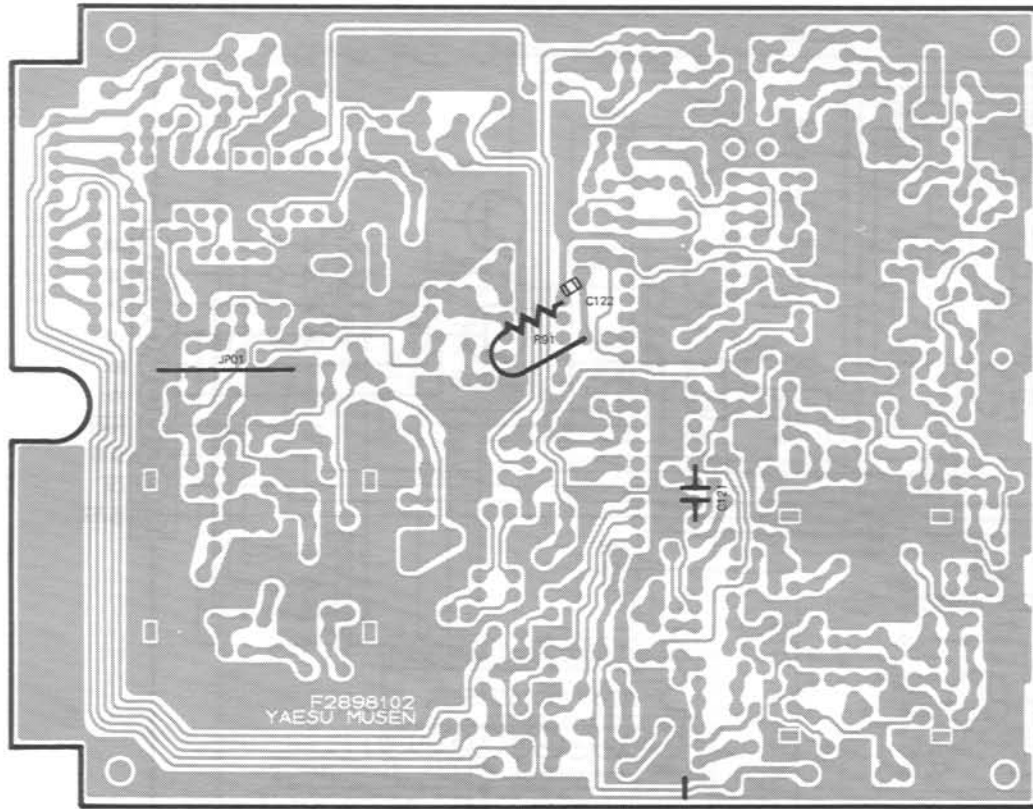

Solder side (obverse)

220MHz PLL UNIT VOLTAGE CHART

(DC VOLTS)

	E(S)	C(D)	(G ₁) ^B	(G ₂)	REMARKS		E(S)	C(D)	(G ₁) ^B	(G ₂)	REMARKS
Q1001	0.64	8.32	0			Q1016	1.17	8.67	0		
Q1002	0	8.53	0			Q1017	1.08	7.81	1.86		
Q1003	1.38	8.64	1.77			Q1024	0	5.08	0.70		
Q1004	0	0.06	0.71			Q1025	0	4.55	0.67		
Q1005	0	4.63	0			Q1026	0	0.09	0.69		
Q1006	0.97	6.00	1.58			Q1027	0	0.09	0.69		
Q1007	0.73	5.33	1.46			Q1028	0	0.09	0.09		
Q1010	2.44	8.51	3.04			Q1029	0	0.07	0.68		
Q1011	1.15	8.70	1.74			Q1030	0	0.07	0.68		
Q1012	0.95	8.77	1.63			Q1031	0	0.07	0.68		
Q1013	0	4.74	0			Q1032	0	0.14/8.93	4.73/0		RX/TX
Q1014	1.05	5.21	1.62			Q1033	0	8.93/0.27	0/4.73		RX/TX

Q10
Q10
Q10
Q10
Q10
Q10
Q10

220MHz BAND MODULE(FEX-736-220) OPTION

220MHz PLL UNIT F2898102(No.1xxx)

J01

3

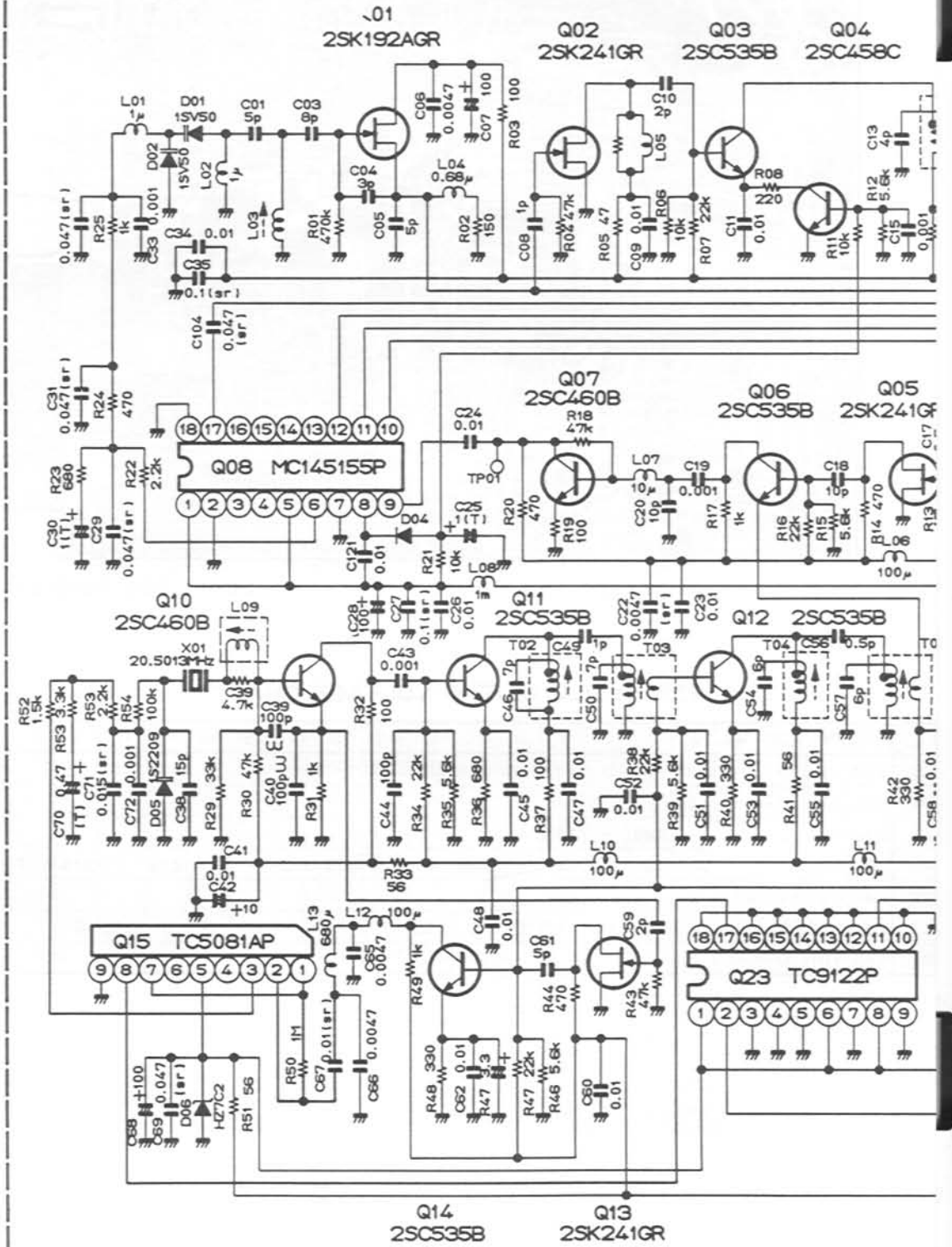

RESISTOR VALUES ARE IN Ω, kΩ, MΩ;
CAPACITOR VALUES ARE IN pF, μF.
INDUCTOR VALUES ARE IN HENRIES, UNLESS OTHERWISE SPECIFIED.

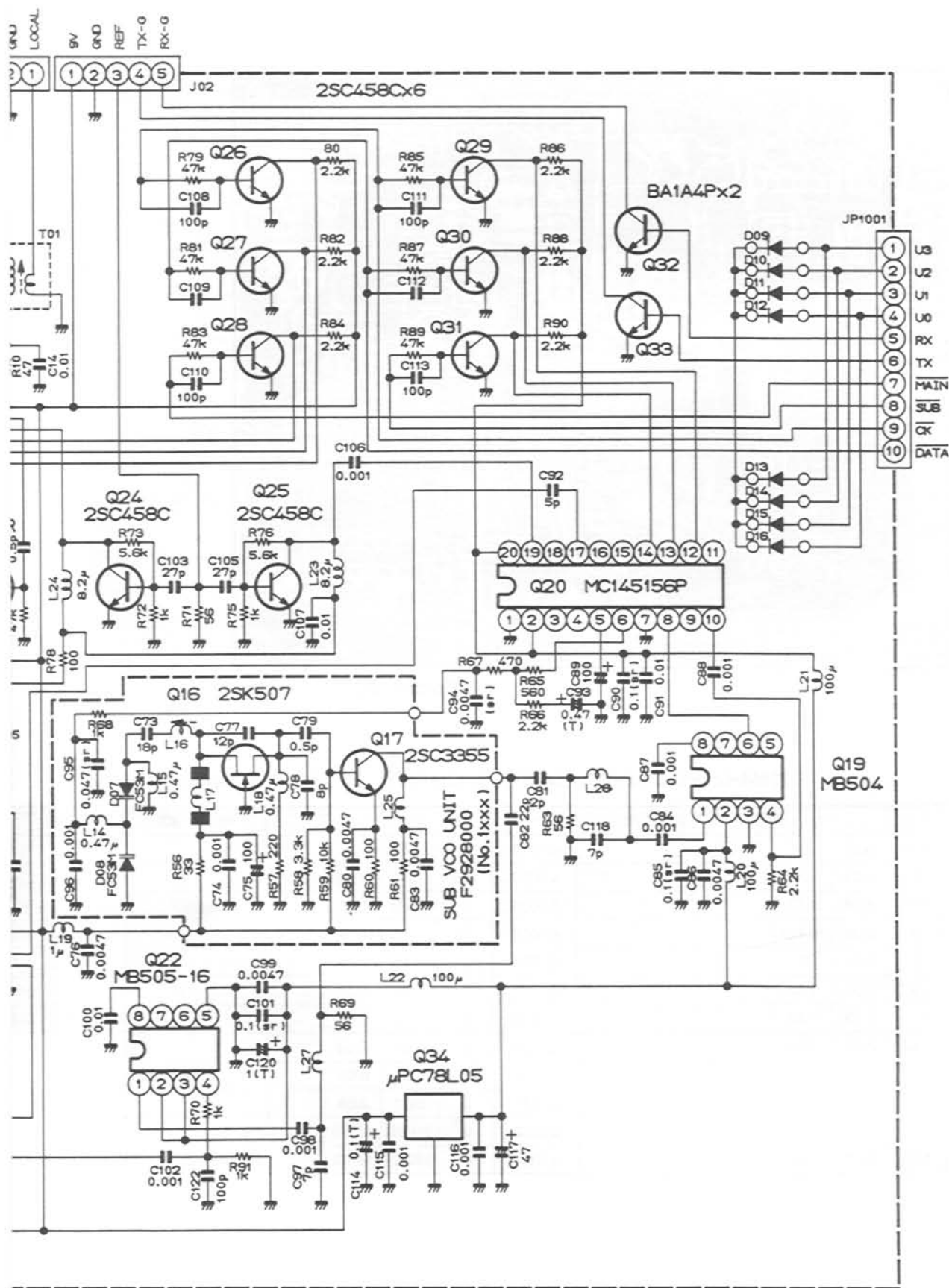

DIODES ARE TYPE 1SS270 UNLESS OTHERWISE NOTED.
 (T) CAPACITORS ARE TANTALUM.
 (s) CAPACITORS ARE SEMICONDUCTOR CERAMIC. 25Vv:

NOTE.

1200MHz PLL UNIT (No. 1 XXX)

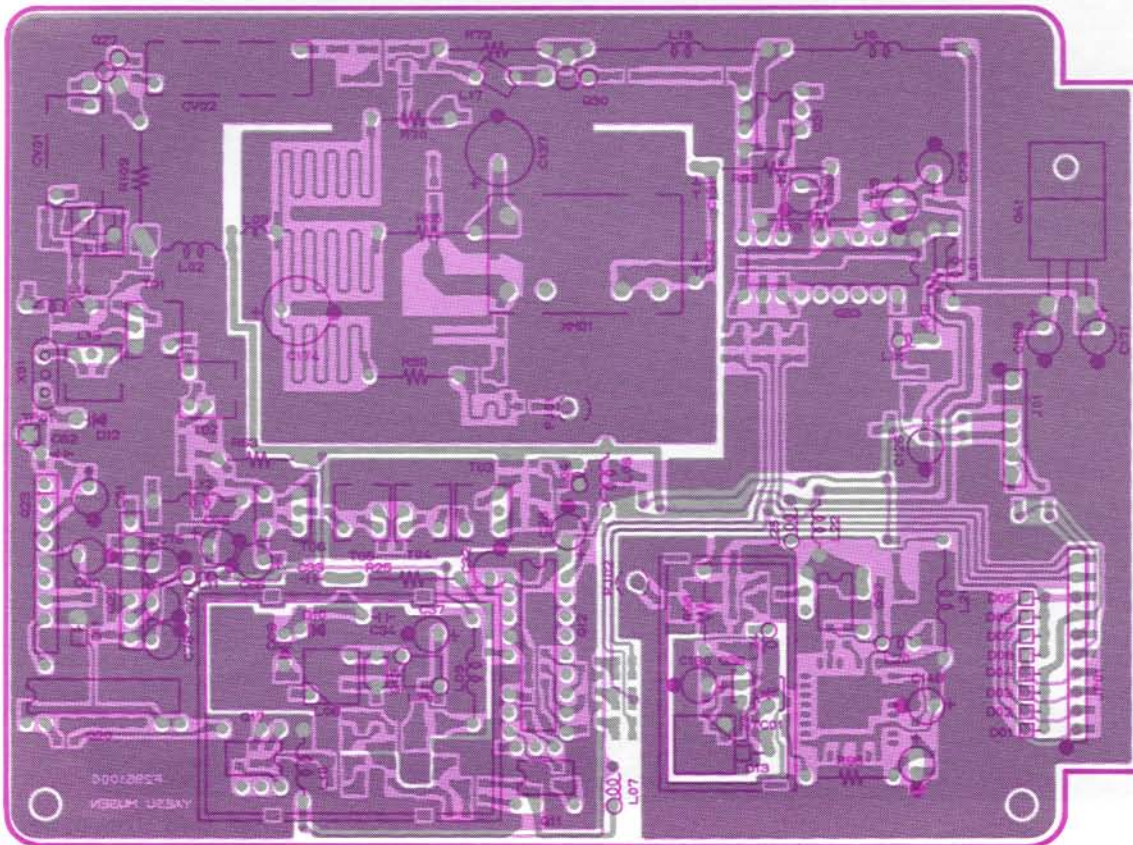

Component side (obverse)

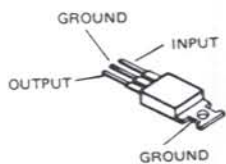

μPC7805H (Q1041)

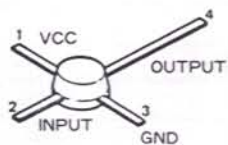

μPC1651G (Q1027,1030)

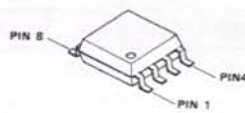

μPC1659G (Q1028)

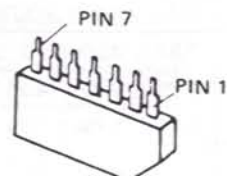

μPC577H (Q1022)

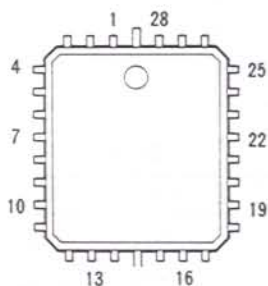

MC145163SL (Q1036)

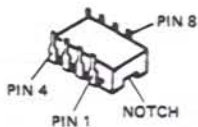

MB503 (Q1031)
MB504L (Q1011)
μPB551C (Q1037)

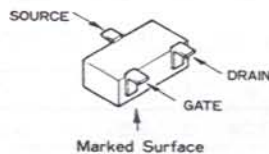

2SK302Y (TY)
(Q1019,1025)

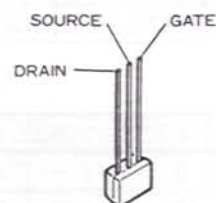

2SK507F (Q1013)



2SK192

MHz BAND MODULE (FEX-736-1.2) OPTION

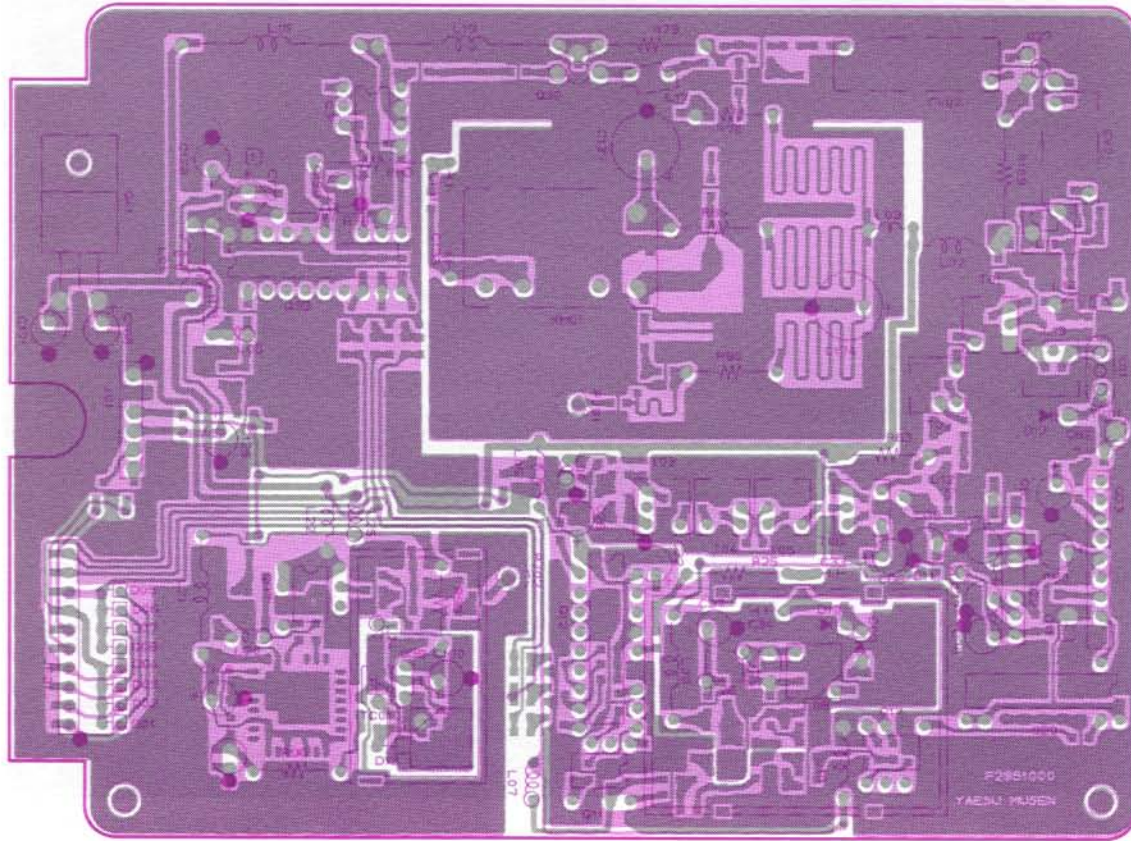

Component side (reverse)

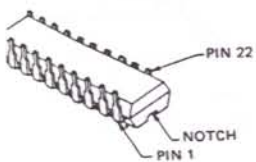

M145156P
(Q1012,1033)

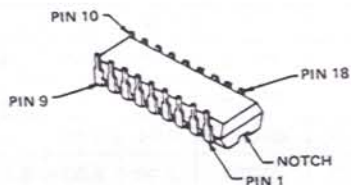

MB505-16 (Q1017)
T69122P (Q1020)

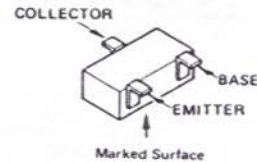

2SA812 (M6) (Q1032)
2SC1623 (L6)

(Q1001,1002,1003)
1004,1005,1006
1007,1008,1009
1010,1018

2SC2620 (QB)
(Q1021,1024,1039)
1040

2SC2712 (LG)
(Q1009,1010,1035)

2SC3120 (HB)
(Q1014,1015,1016)
1026

2SC3356 (R22) (Q1034)



AGR (Q1038)

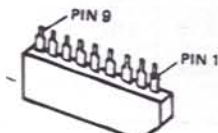

TC5081AP (Q1023)



3SK165 (J0) (Q1029)

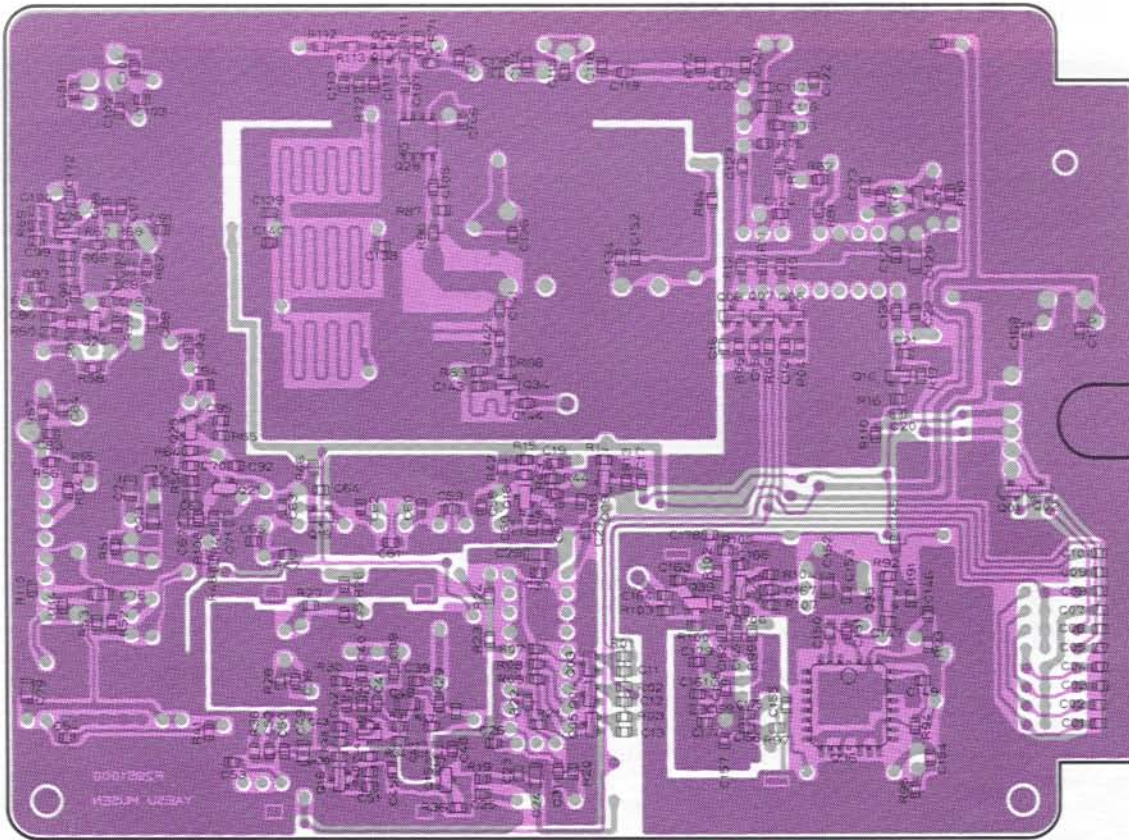

Chip side (reverse)

1200MHz PLL UNIT IC VOLTAGE CHART

(DC VOLTS)

	1(IN)	2(GND)	3(OUT)	4	5	6	7	8	9	10	REMARKS
Q1011	2.37	4.96	0	2.74	0	3.20	—	2.39			
Q1017	2.35	2.35	4.95	0	2.52	0	—	—	2.35		
Q1022	5.15	1.79	1.79	0	4.30	1.94	8.69				
Q1023	—	—	2.00	—	7.52	—	3.70	0.63	0		
Q1027	0.89	5.57	0	3.18							
Q1028	0.74	0	0	0	5.79	0	0	8.62			
Q1030	0.88	4.77	0	3.07							
Q1031	2.37	4.87	4.87	2.80	0	3.49	—	2.37			
Q1037	4.83	3.21	0	0	2.35	0	4.83				
Q1041	8.87	0	5.00								

1200MHz PLL UNIT IC VOLTAGE CHART

(DC VOLTS)

	1	2	3	4	5	6	7	8	9	10	11	12	13	14	15	16	17	18	19
Q1012	0	8.54	—	—	8.54	1.24	0	7.50	—	3.91	0.05	0.05	0.05	—	—	—	—	—	3.76
Q1020	7.52	0	0	0	0	0	0	7.52	7.52	0	0	0	0	0	0	0	0.63	0	
Q1033	7.80	7.80	—	—	7.80	4.42	0	7.61	7.74	3.53	0.05	0.05	0.05	—	—	—	—	4.22	3.49
Q1036	4.26	0	8.63	5.38	0	0	—	—	8.63	—	—	8.63	—	8.63	8.03	—	8.63	8.63	—
	20	21	22	23	24	25	26	27	28										
Q1012	8.85																		
Q1020																			
Q1033	0																		
Q1036	—	—	—	—	—	—	—	4.19	—										

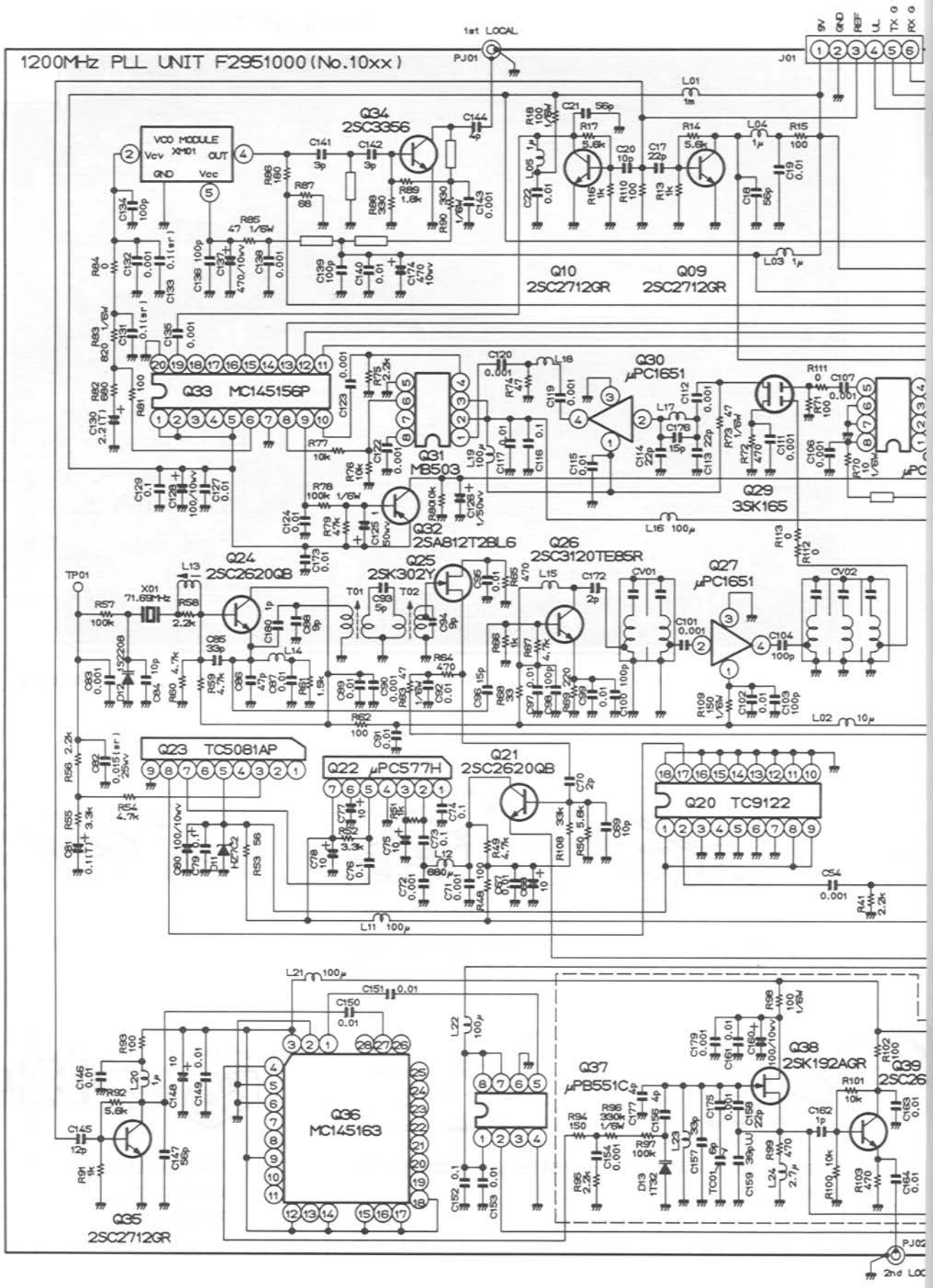

MHz BAND MODULE (FEX-736-1.2) OPTION

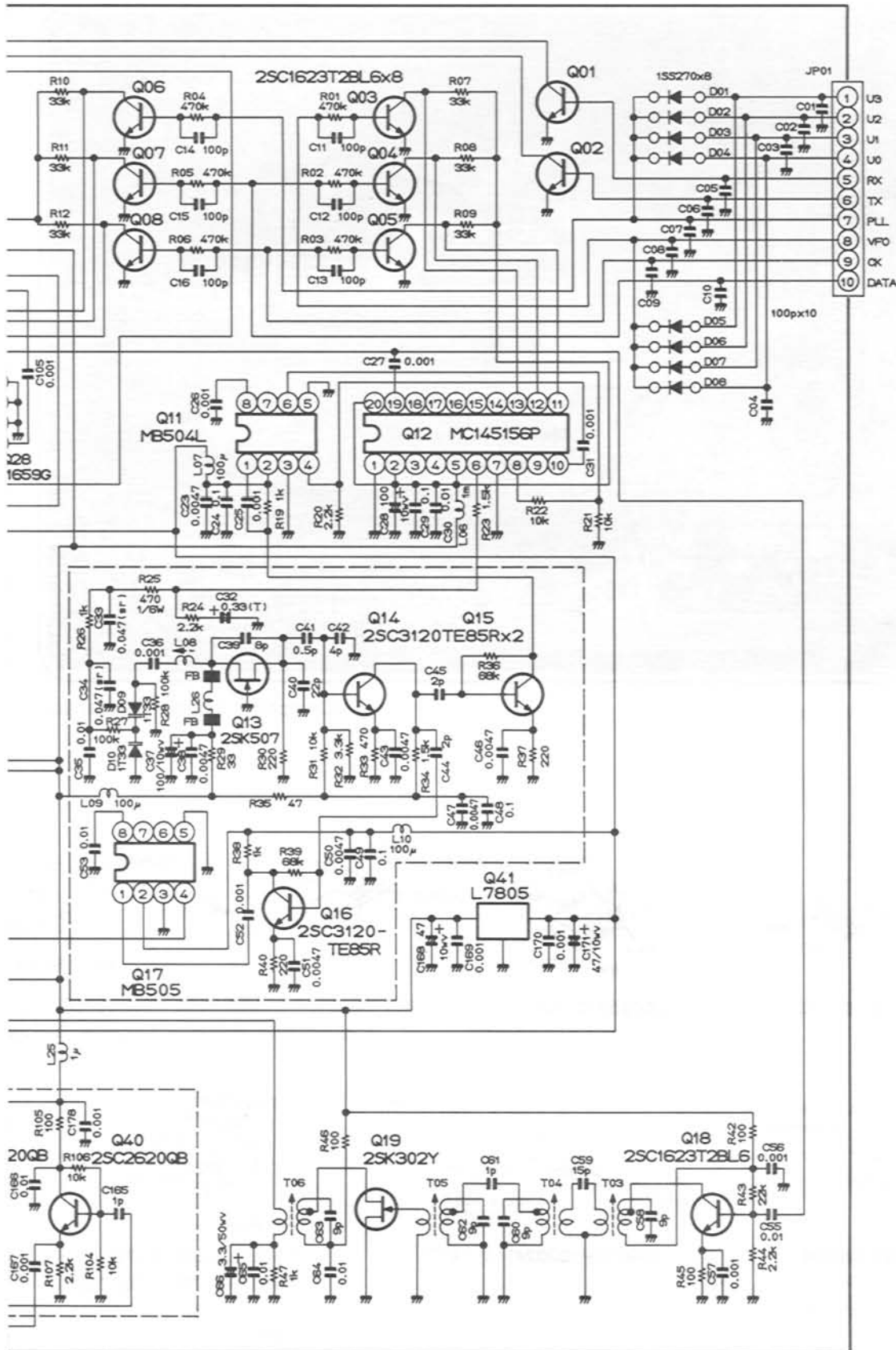

RESISTOR VALUES ARE IN Ω , 1/10W;
CAPACITOR VALUES ARE IN μ F, 50v;
INDUCTOR VALUES ARE IN HENRIES.

(T) CAPACITORS ARE TANTALUM.
(ϵ r) CAPACITORS ARE SEMICONDUCTOR CERAMIC, 25v.
UNLESS OTHERWISE NOTED.

1200MHz BAND MODULE (FEX-736-1.2) OF

1200MHz RF UNIT (No. 2XXX)

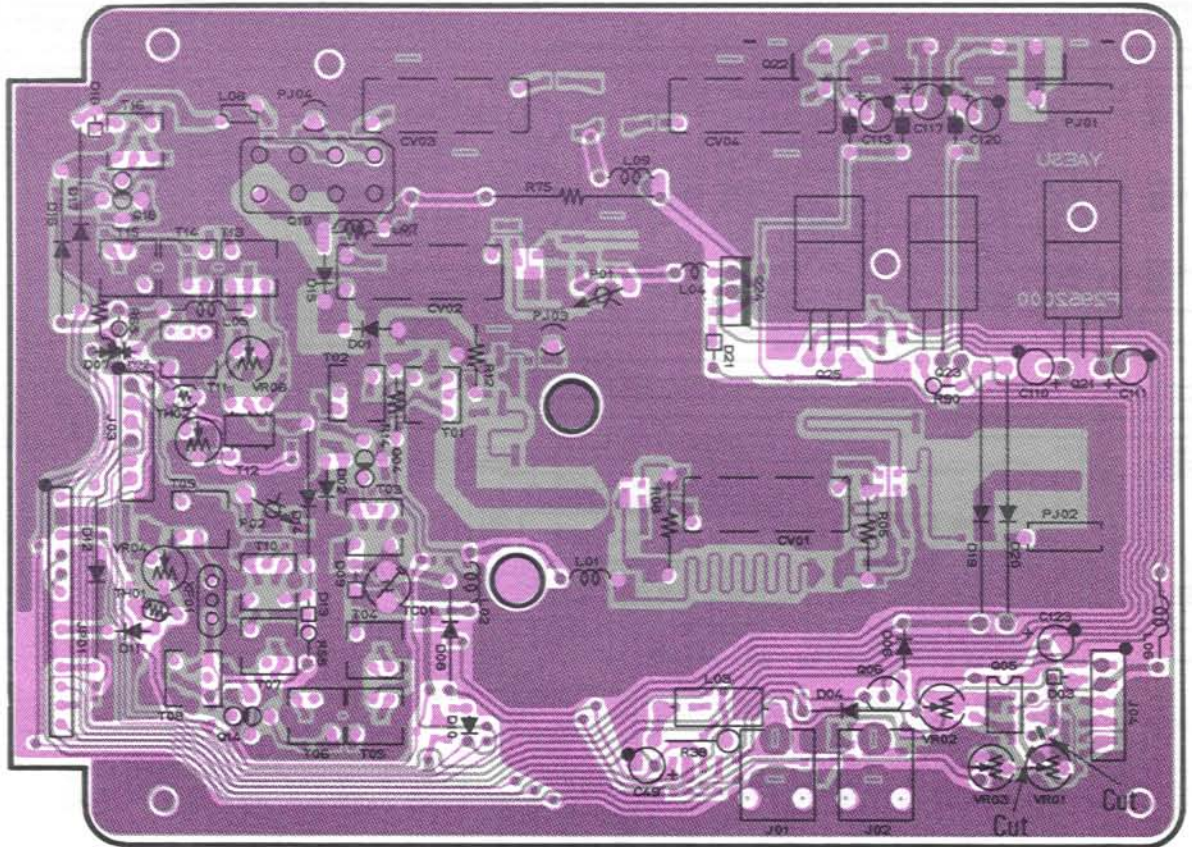

Component side (obverse)

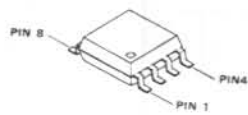

μPC1659G (Q2020)

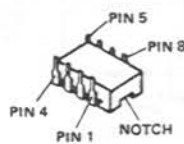

LA6358 (Q2005)

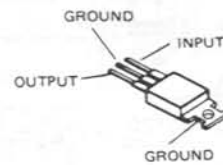

L7809 (Q2021)

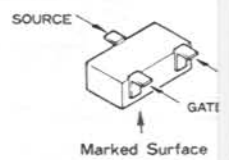

2SK302GR (TG)
(Q2015,2016,20)

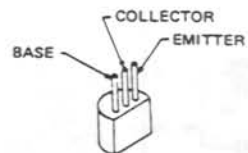

2SA1528 (Q2006)

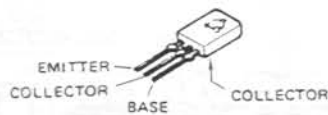

2SB772P (Q2024)

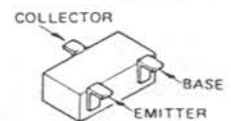

Marked Surface

- FA1L4L (L30) (Q2027)
- FA1L4M (L31) (Q2007,2011)
- 2SA812 (M6)
(Q2008,2009,2010)
- 2SC1623 (L6) (Q2026)
- 2SC2620 (QB) (Q2013)
- 2SC3356 (R22) (Q2002,2012)

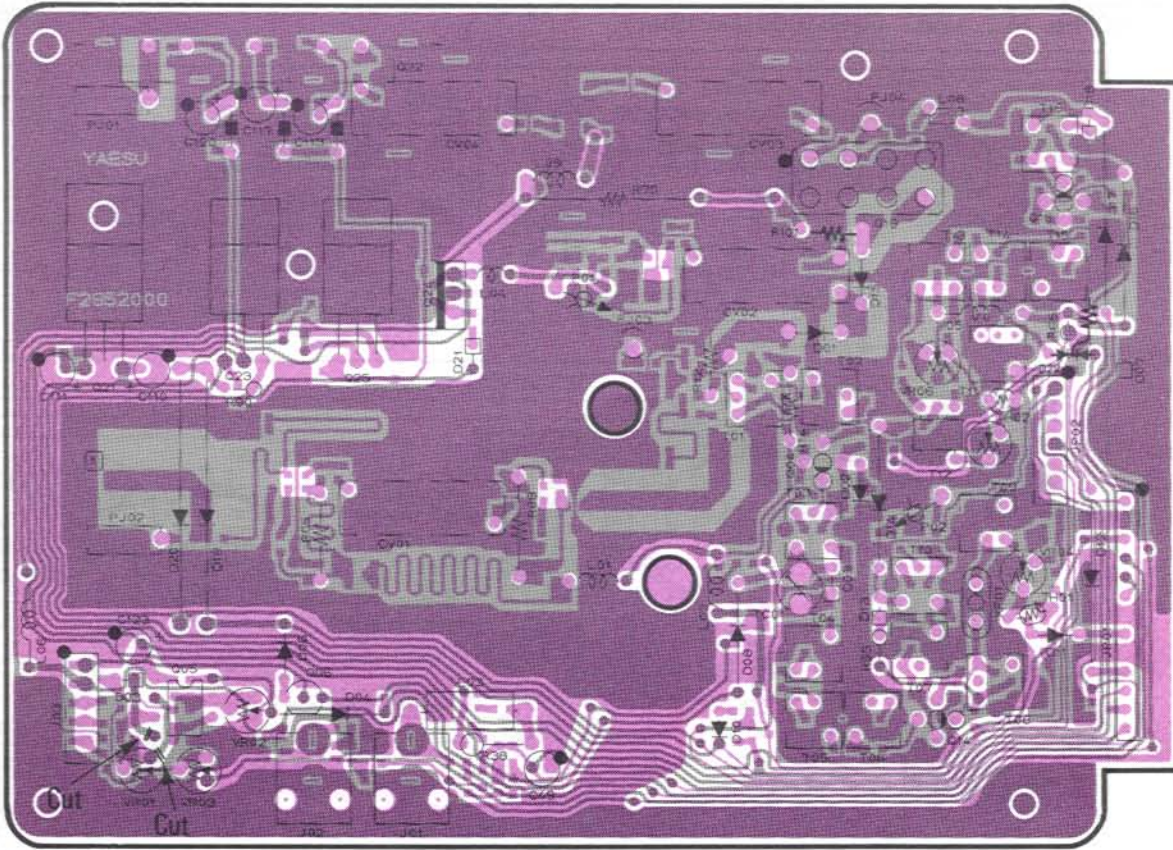

Component side (reverse)

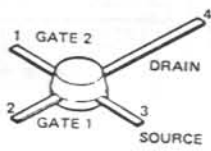

3SK122L
(Q2004,2014,2018)

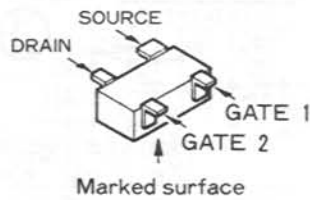

3SK164-0 (F0) (Q2001)
3SK165-0 (J0) (Q2003)

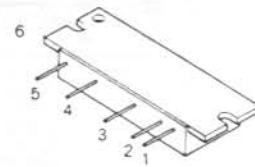

M67715 (Q2022)

1. INPUT
2. Vcc₁
3. Vcc₂
4. Vcc₃
5. OUTPUT
6. FLA

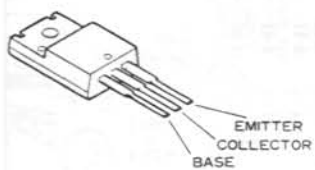

2SB1134R (Q2023)
2SD1667R (Q2025)

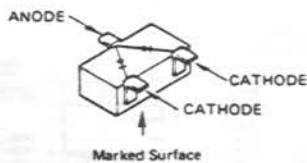

1SS181 (A3) (D2005)

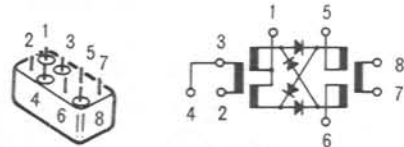

1.RF (IF) 2,5,6,7.CASE GND
3,4.IF (RF) 8.LO
DM-600A24 (Q2019)

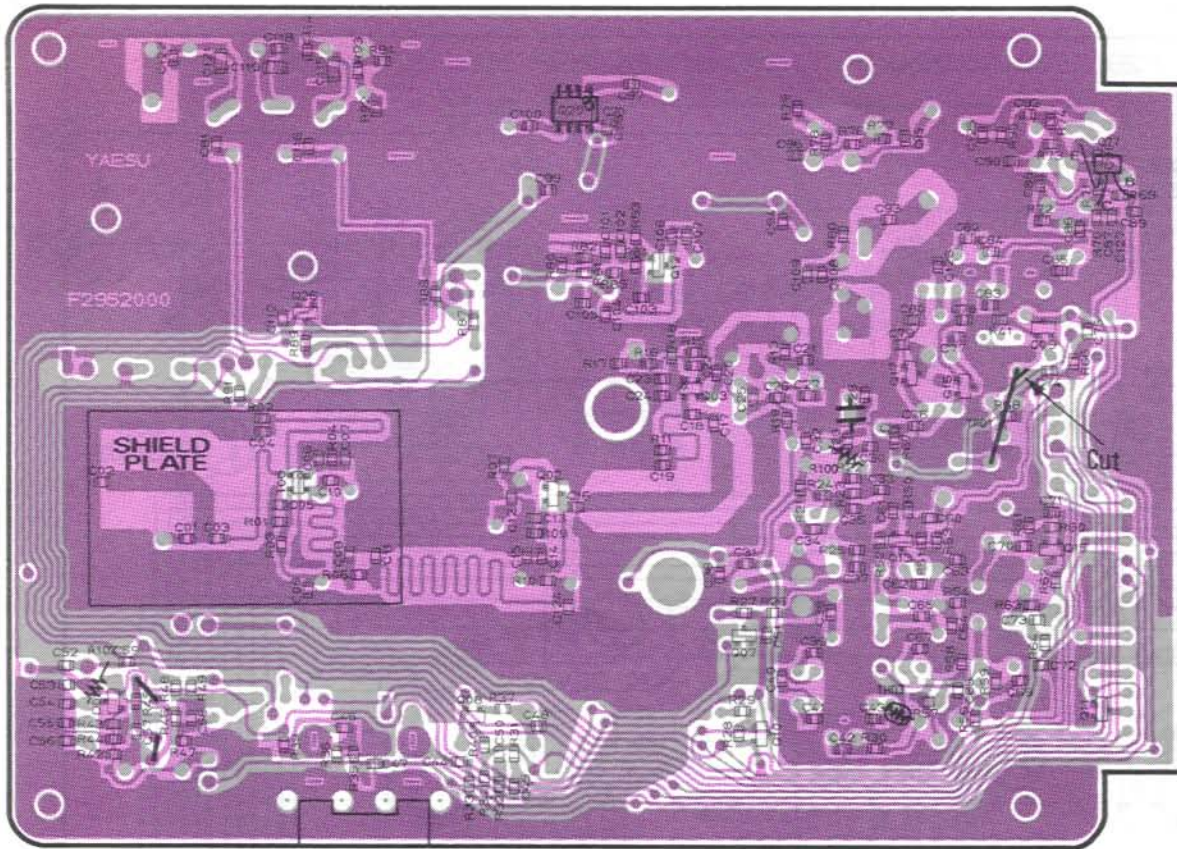

Chip side (obverse)

1200MHz RF UNIT VOLTAGE CHART (DC VOLTS)

	E(S)	C(D)	(G ₁)	B (G ₂)	REMARKS		E(S)	C(D)	(G ₁)	B (G ₂)	REMARKS
Q2001	0.78	8.17	0	1.95		Q2013	1.24	7.87	1.91		
Q2002	0.10	7.78	0.84			Q2014	0.13	8.53	0	0	
Q2003	1.6	7.2	0	0		Q2015	4.16	8.72	4.36		
Q2004	1.40	7.80	1.01	2.00		Q2016	1.0	8.4	0		
Q2006	0/1250	0/1250	0/0.79		PRE AMP OFF/ON	Q2017	1.0	8.4	0		
Q2007	13.38/1326	0/1320	13.38/11.04		W/O TV UNIT/W/TV UNIT	Q2018	1.15	7.63	1.30	3.70	
Q2008	13.30/1230	0/1320	13.30/13.14		W/O TV UNIT/W/TV UNIT	Q2023	13.4	13.3	12.7		
Q2009	0	0	0			Q2024	8.97/8.91	0/8.77	8.97/8.13		RX/TX
Q2010	8.87/8.80	8.77/8.76	0		W/O TV UNIT/W/TV UNIT	Q2025	0/7.90	0/8.73	0/8.48		RX/TX
Q2011	0	0	0/8.41		RX/TX	Q2026	0	0	0		
Q2012	0	7.15	0.73			Q2027	0	0/3.70	2.67/1.25		RX/TX

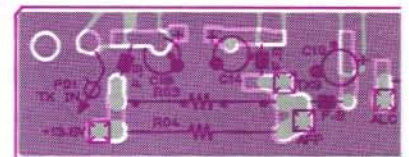

1200MHz RF UNIT IC VOLTAGE CHART (DC VOLTS)

	1(IN)	2(GND)	3(OUT)	4	5	6	7	8	9	10	REMARKS
Q2005	1.07	1.90	0	1.84	6.38	6.38	1.00	8.93			@ 10W output
Q2019	0	0	0	-	0	0	0	0			
Q2020	0.74	0	0	0	5.84	0	0	8.70			
Q2021	12.6	0	9.0								
Q2022	-	7.64	7.64	7.64	-						
Q3001	-	13.8	9.0	13.2	-						@ 10W output

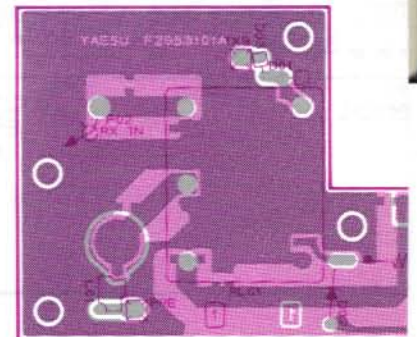

1200MHz BAND MODULE (FEX-736-1.2) OPTION

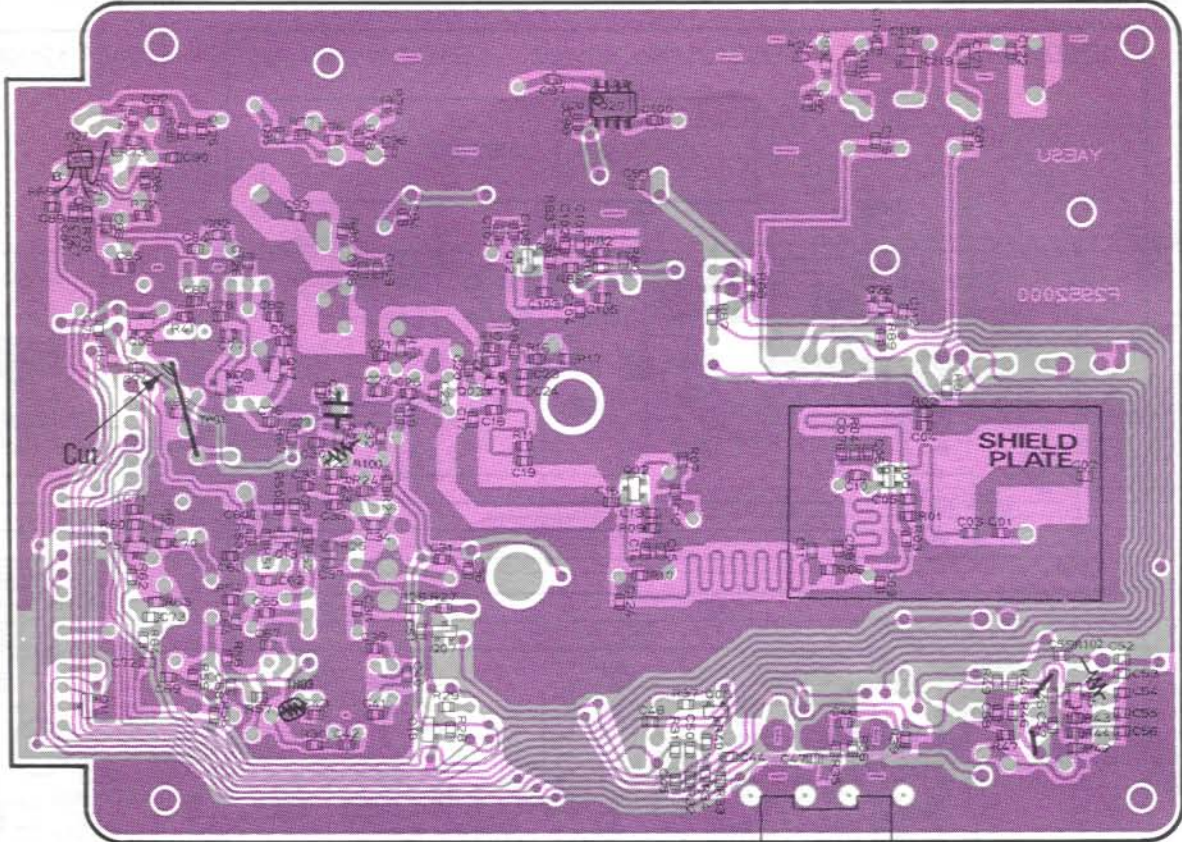

Chip side (reverse)

1200MHz PA UNIT (No. 3XXX)

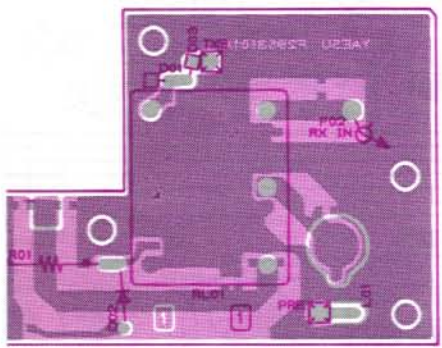

Component side (obverse)

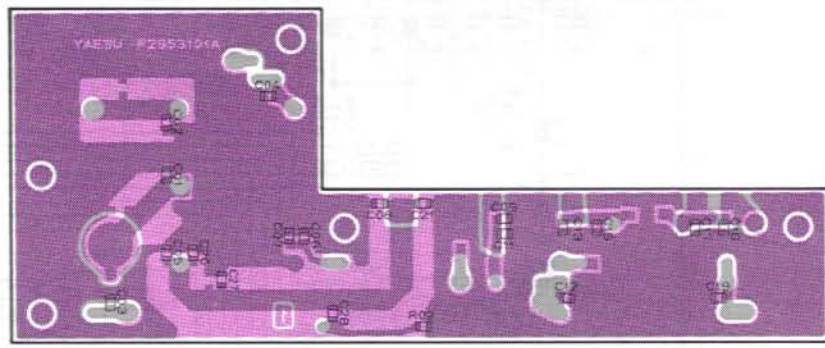

Chip side (obverse)

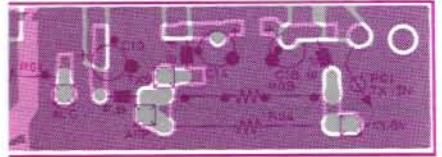

Component side (reverse)

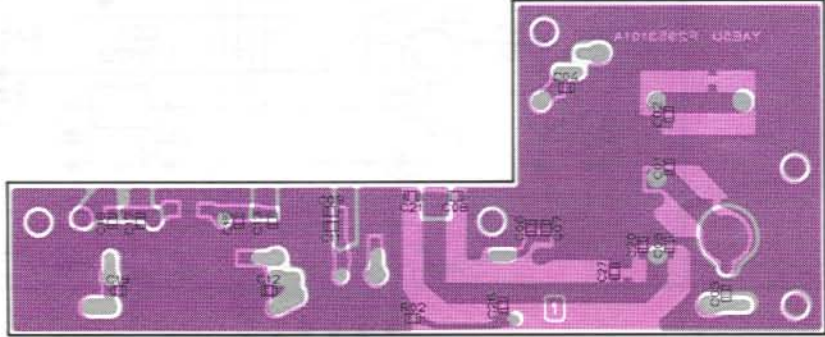

Chip side (reverse)

1200MHz BAND MODULE (FEX-736-1.2)

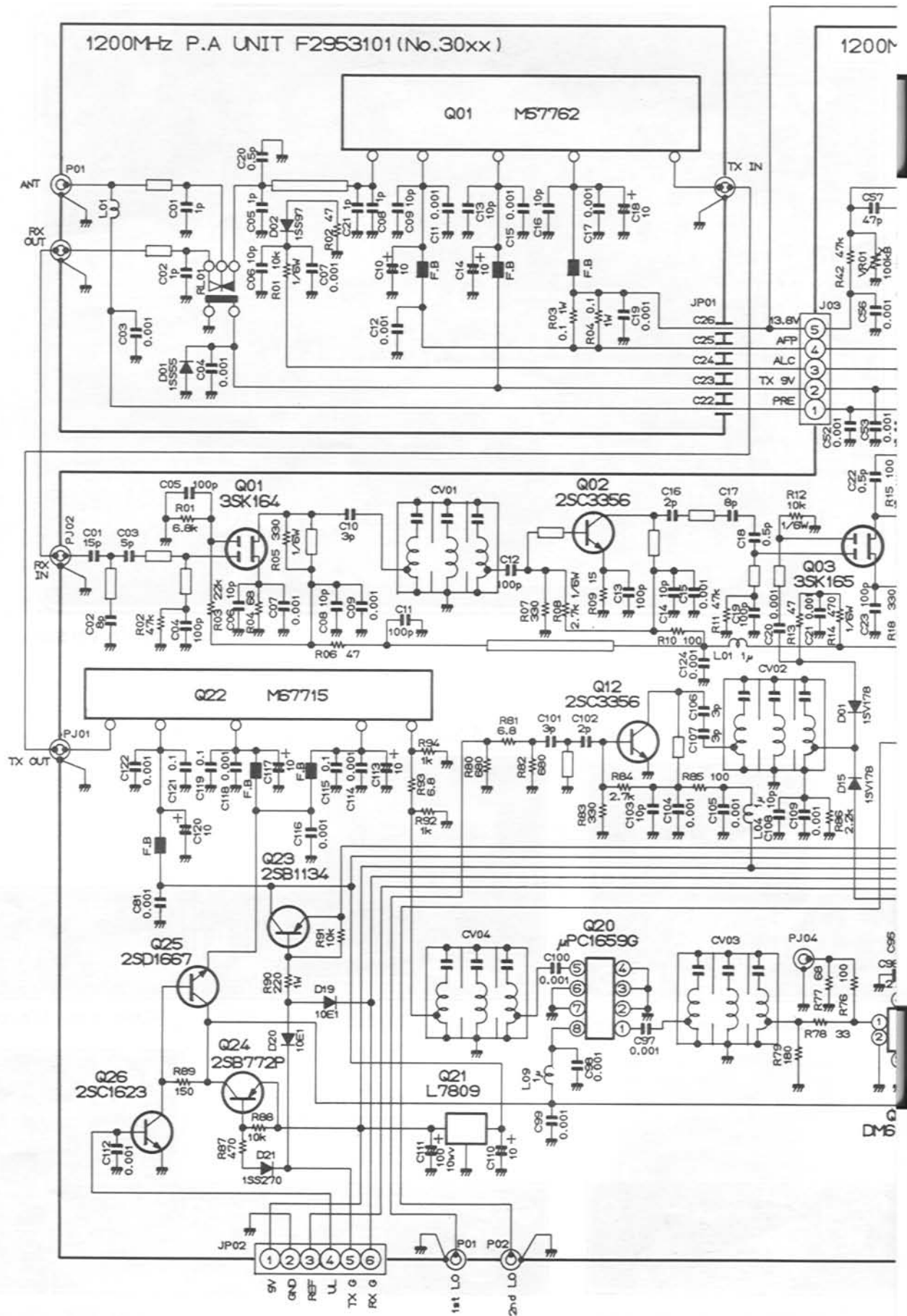

Hz RF UNIT F2952000 (No.20xx)

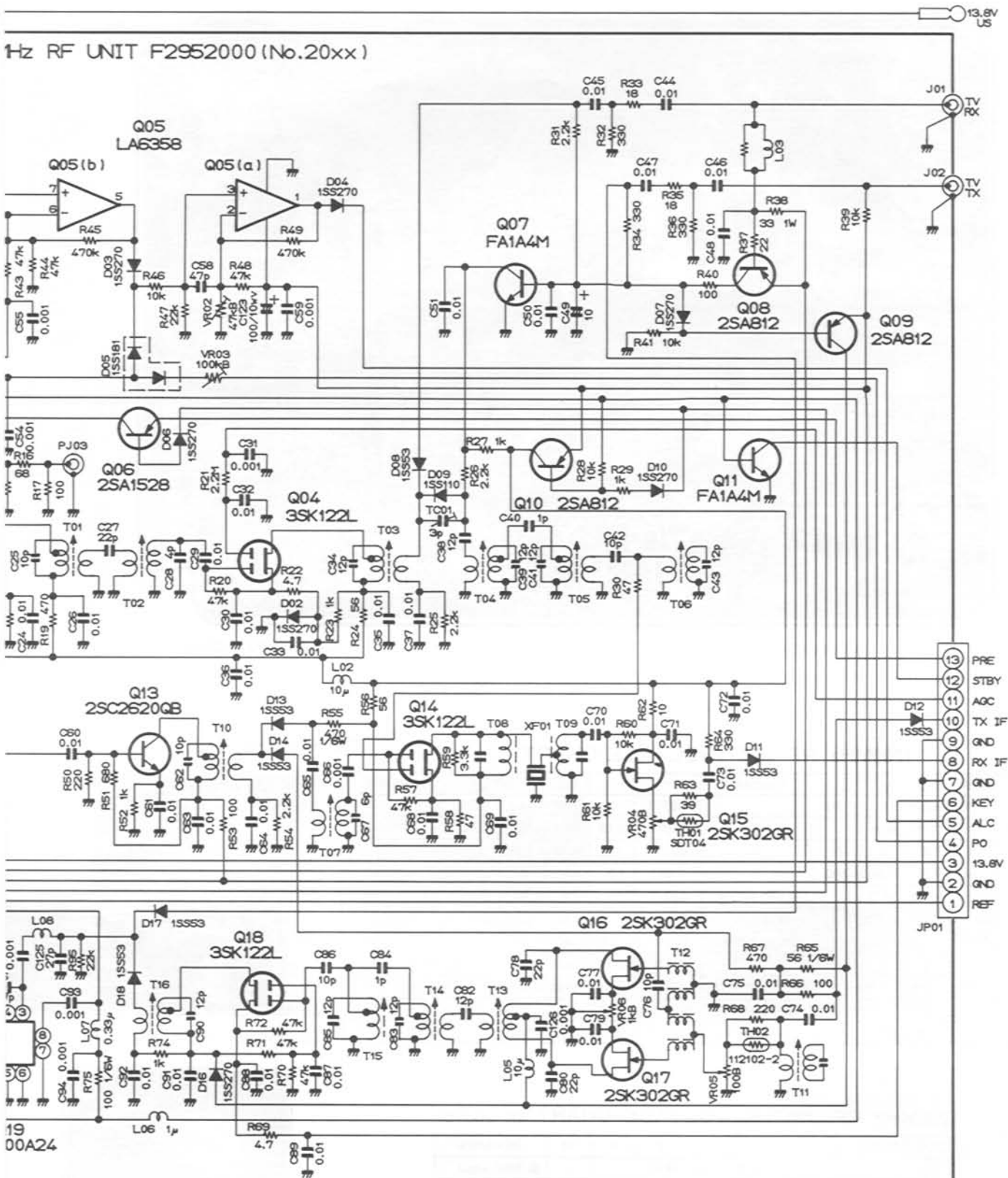

RESISTOR VALUES ARE IN Ω , 1/10W;
CAPACITOR VALUES ARE IN μ F.
INDUCTOR VALUES ARE HENRIES.
UNLESS OTHERWISE NOTED.

(144MHz RX) LEVEL DIAGRAM

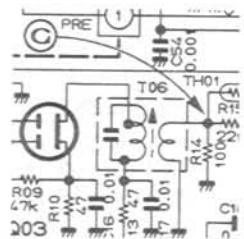
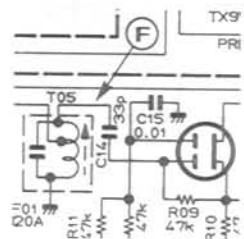
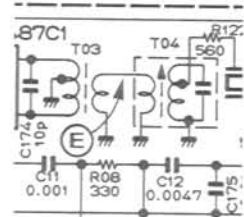
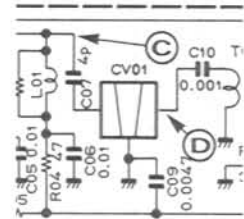
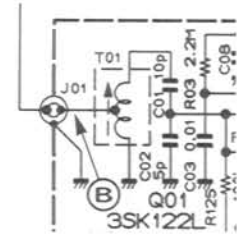
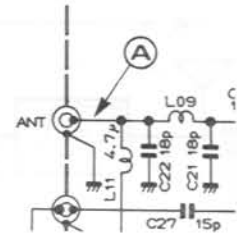
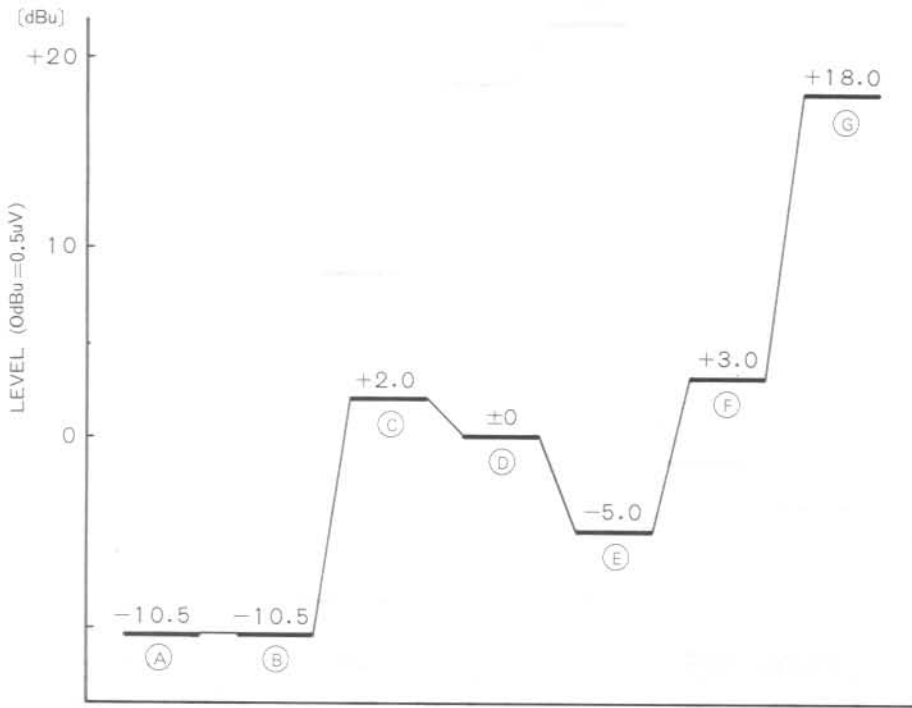
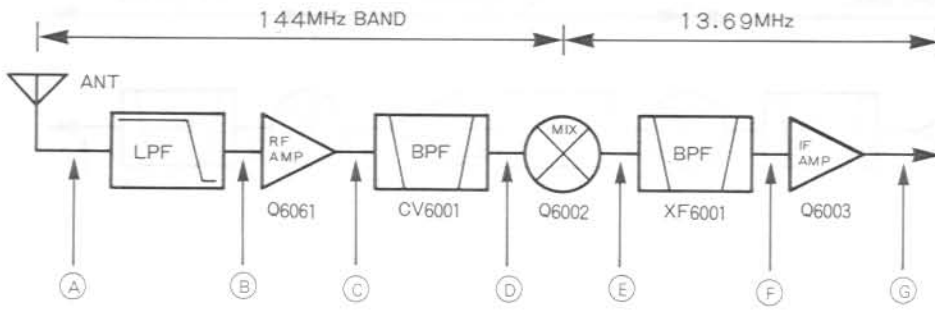

LEVEL DIAGRAM (430MHz RX)

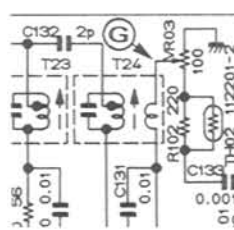
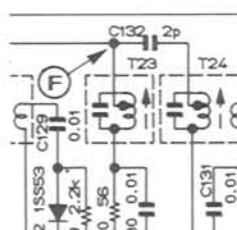
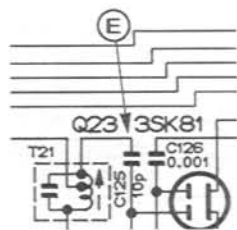
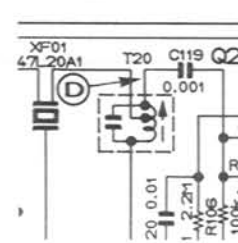
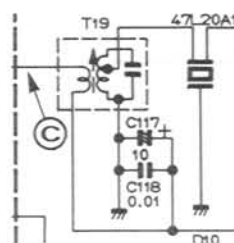
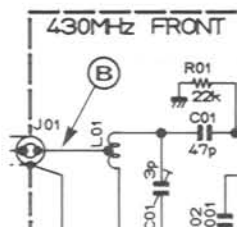
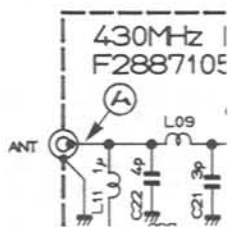
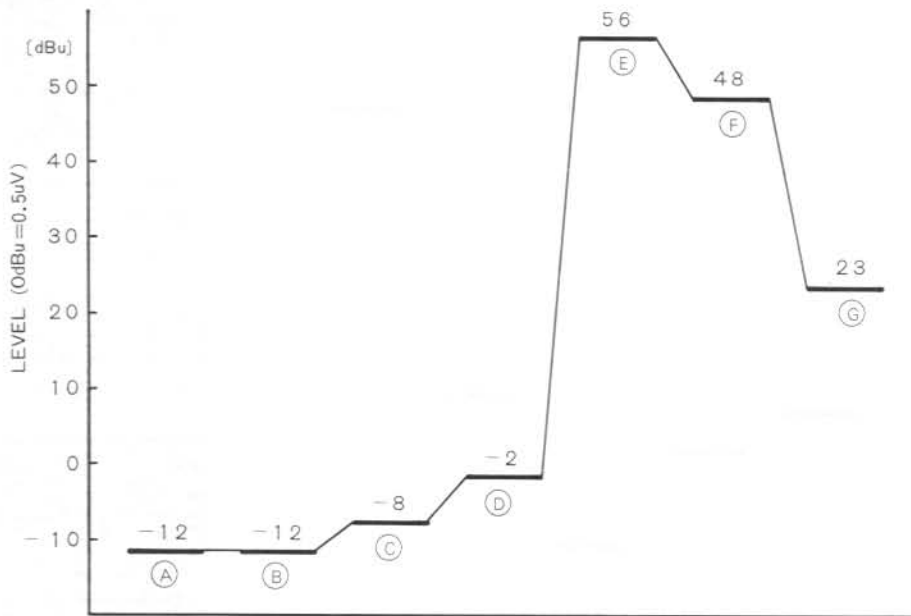
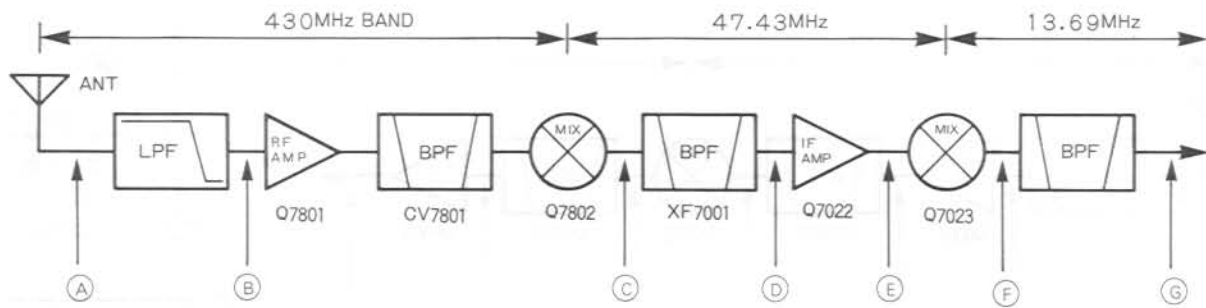

(144MHz TX) LEVEL DIAGRAM

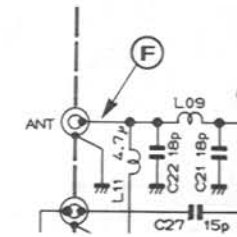
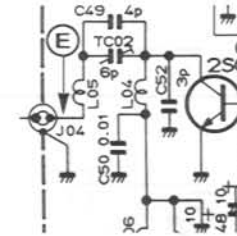
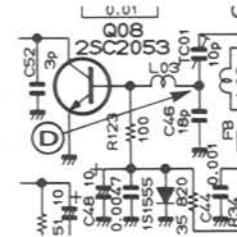
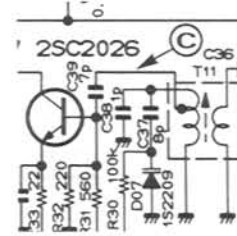
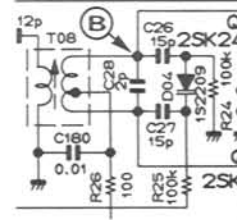
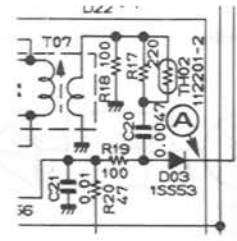
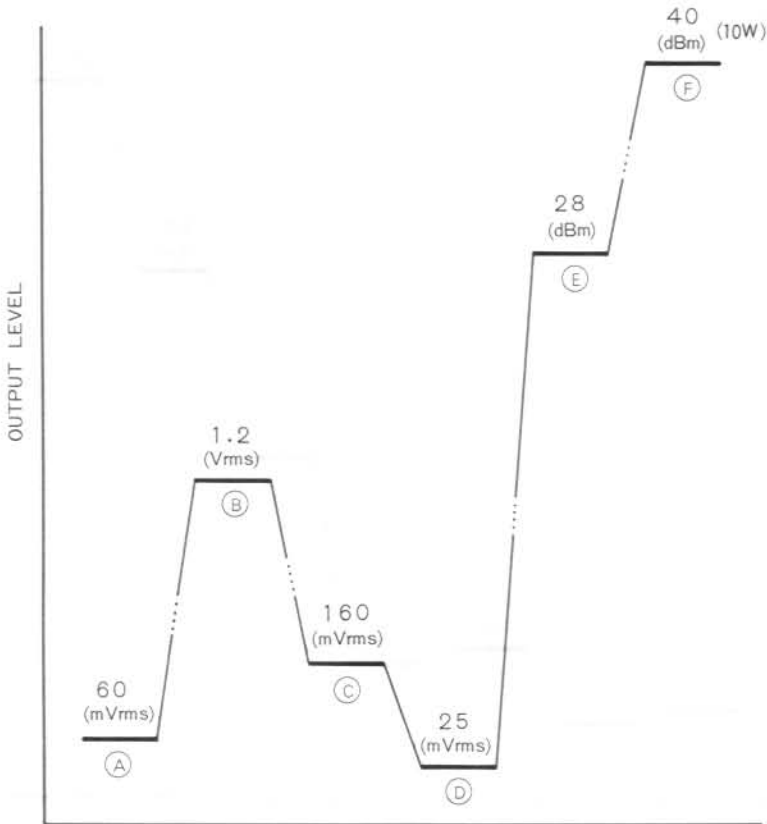
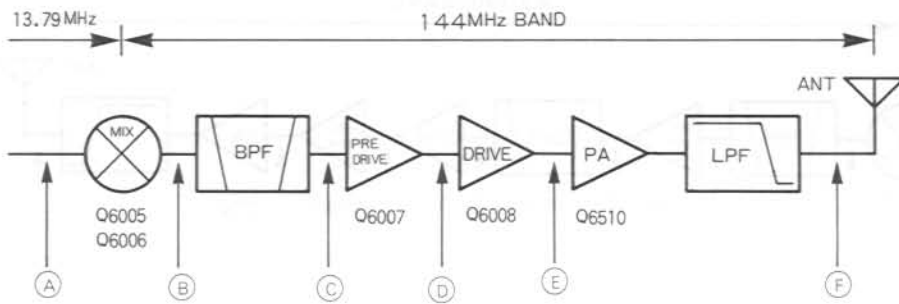

LEVEL DIAGRAM (430MHz TX)

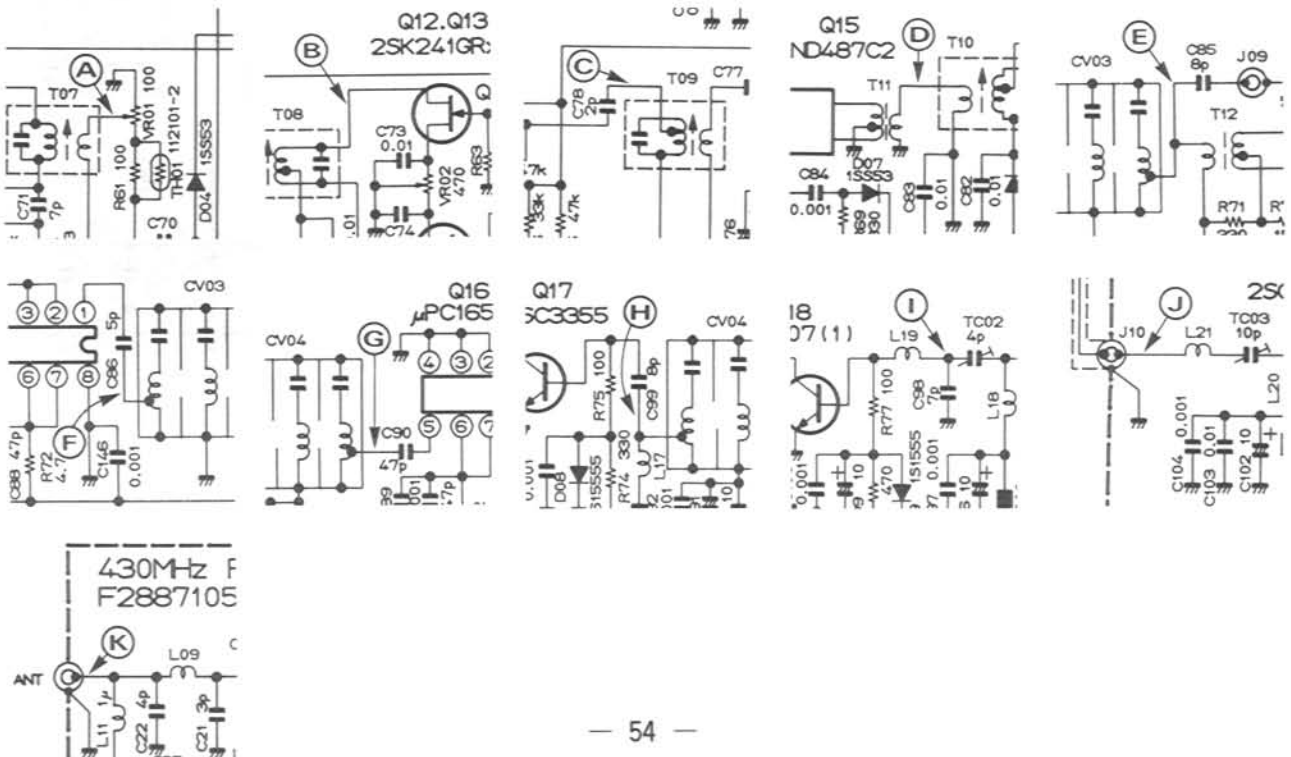
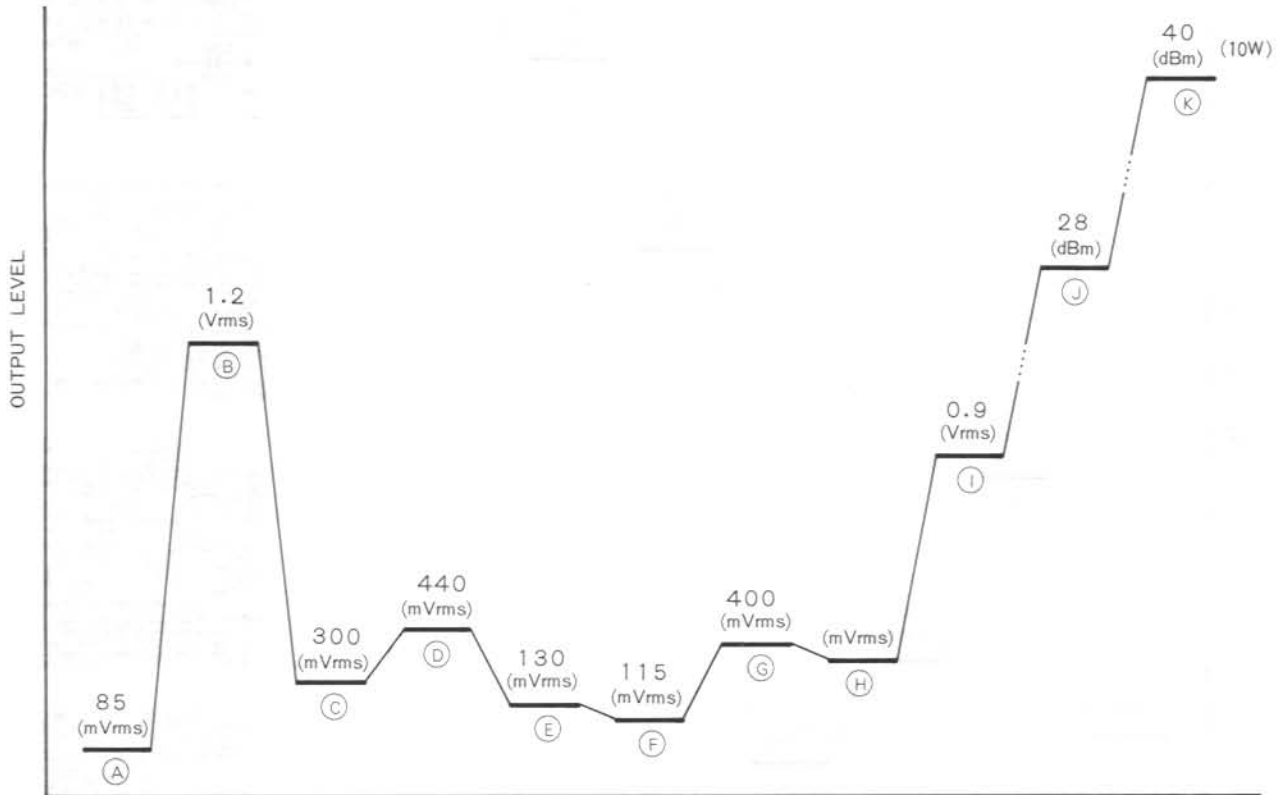
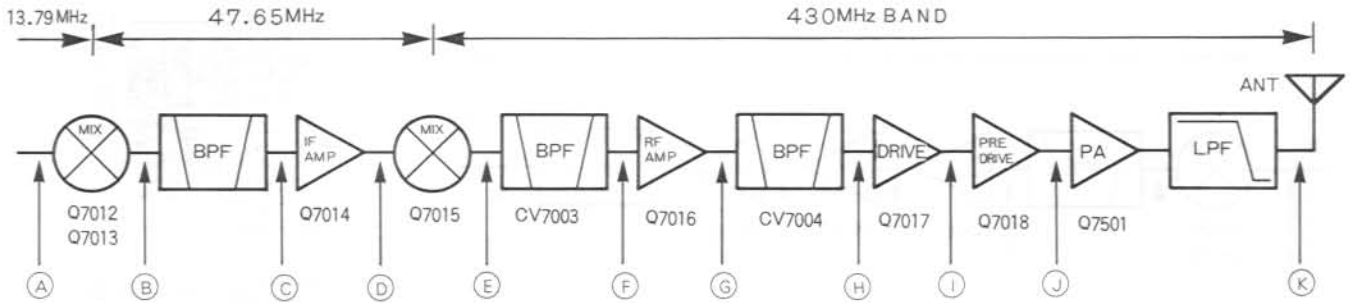

ALIGNMENT

The FT-736R is carefully designed to allow the knowledgeable operator to make all adjustments required for various station conditions, modes and operator preferences simply from the controls on the front panel, without opening the case of the transceiver. These adjustments are described in the FT-736R Operating Manual:

The following procedures cover the sometimes critical and tedious adjustments that are not normally required once the transceiver has left the factory. However, if damage occurs and some parts subsequently be replaced, realignment may be required. If a sudden problem occurs during normal operation, it is likely due to component failure; realignment should not be done until after the faulty component has been replaced.

We recommend servicing be performed only by authorized Yaesu service technicians who are experienced with the circuitry and fully equipped for repair and alignment. Therefore, if a fault is suspected, contact the dealer from whom the transceiver was purchased for instructions regarding repair. Authorized Yaesu service technicians realign all circuits and make complete performance checks to ensure compliance with factory specifications after replacing any faulty components.

Those who do undertake any alignment are cautioned to proceed at their own risk. Problems caused by unauthorized attempts at realignment are not covered by the warranty policy. Also, Yaesu must reserve the right to change circuits and alignment procedures in the interest of improved performance, without notifying owners.

Under no circumstances should alignment be attempted unless the normal function and operation of the transceiver are clearly understood, the cause of the malfunction has been clearly pinpointed and any faulty

components replaced, and the need for realignment determined to be absolutely necessary.

The following test equipment (and thorough familiarity with its correct use) is necessary for complete realignment. Correction of problems caused by misalignment resulting from use of improper test equipment is not covered under the warranty policy. While most steps do not require all equipment listed, interactions of some adjustments may require complex adjustments be performed afterwards. Do not attempt to perform only a single step unless it is clearly isolated electrically from all other steps. Rather, have all test equipment ready before beginning, and follow all of the steps in a section in the order they are presented.

A 50-ohm dummy load must be connected to the antenna jack in steps calling for transmission (pressing the MOX button). Correct alignment is not possible with an antenna.

The SHIFT control must be set to the 12 o'clock position, the NOTCH control set fully counterclockwise to OFF, the RF gain control fully clockwise (maximum), and the SQL control must be fully counterclockwise, unless stated otherwise.

After completing one step, read the following step to determine whether the same test equipment will be required. If not, remove the test equipment (except dummy load and wattmeter, if connected) before proceeding.

CAUTION!!!

The front panel PREAMP button must be set to OFF, and jumper plugs J5016-J5019 must be removed from the AF Unit to prevent DC voltage at the Antenna Jacks (which could damage the test equipment).

ALIGNMENT

Alignment Precautions

Correct alignment requires that the ambient temperature be the same as that of the transceiver and test equipment, and that this temperature be held constant between 20 and 30 °C (68 to 86 °F). When the transceiver is brought into the shop from hot or cold air it should be allowed some time for thermal equalization before alignment.

Alignments must only be made with oscillator shields and circuit boards firmly affixed in place. Also, the test equipment must be thoroughly warmed up before beginning.

Alignment values assume an internal DC bus voltage of 13.5V DC.

Note: Signal levels in dB referred to in the alignment procedure are based on 0dBu=0.5uV.

Test Equipment:

Spectrum analyzer covering up to 1300 MHz, or to top edge of highest frequency band installed

Tracking generator covering up to 1300 MHz, or to top edge of highest frequency band installed

RF signal generator covering up to 1300 MHz, or to top edge of highest frequency band installed, with calibrated output and modulation

RF voltmeter ranging from 5mV to 3Vrms, with 5% accuracy to 1300 MHz, or to top edge of highest frequency band installed

Frequency counter with 0.1 ppm accuracy to 1300 MHz, or to top edge of highest frequency band installed

DC voltmeter with at least 10 Megohms impedance

In-line wattmeter accurate to 1300 MHz, or to top edge of highest frequency band installed

50-ohm dummy load, non-reactive to 1300 MHz, or to top edge of highest frequency band installed, 30-watt capacity

FM Deviation meter and SINAD meter

Sampling coupler "T"

AF signal generator with adjustable output from 0.5 to 100mV

AF millivoltmeter

Oscilloscope with 100 MHz bandwidth

(PLL) ALIGNMENT

I. PLL

A. 144 MHz PLL Sub Loop (on 144 MHz Main Unit - requires DC voltmeter)

1. Connect the DC voltmeter between TP6004 and chassis ground.
2. Tune the transceiver to 14x.01999 MHz, CW mode, and adjust L6019 for 4.2V on the voltmeter.
3. Retune the transceiver to 14x.02000 MHz and confirm at least 0.6V on the voltmeter.
4. Disconnect the voltmeter.

B. 144 MHz PLL VCXO (on 144 MHz Main Unit - requires oscilloscope and DC voltmeter)

1. Connect the oscilloscope to TP6002 and the voltmeter between TP6003 and chassis ground.
2. Tune the transceiver to 14x.01999 MHz, CW mode, and adjust L6023 for 5.0V on the voltmeter.
3. Retune the transceiver to 14x.02000 MHz and confirm at least 1.0V on the voltmeter.
4. Adjust T6013-T6016 for maximum amplitude on the 'scope.
5. Disconnect the 'scope and voltmeter.

C. 144 MHz PLL Main Loop (on 144 MHz Main Unit - requires DC voltmeter)

1. Connect the DC voltmeter between TP6001 and chassis ground.
2. Tune the transceiver to the low band edge, CW mode, and adjust L6009 for 2.0V on the voltmeter.
3. Retune the transceiver to the high band edge and confirm $3.0 \pm 0.5V$ (or $2.0 \pm 0.5V$ in versions B1, C1 and H1) on the voltmeter.
4. Disconnect the voltmeter.

D. Transmitter PLL (on TX Unit, requires DC voltmeter)

1. Connect the voltmeter between the exposed lead of R4001 and chassis ground.
2. Adjust T4001 for 4.0V on the voltmeter.
3. Remove the voltmeter.

E. Receiver PLL (on RX Unit, requires DC voltmeter)

1. Connect the voltmeter between the exposed lead of R3005 and chassis ground.
2. Adjust T3001 for 4.0V on the voltmeter.
3. Remove the voltmeter.

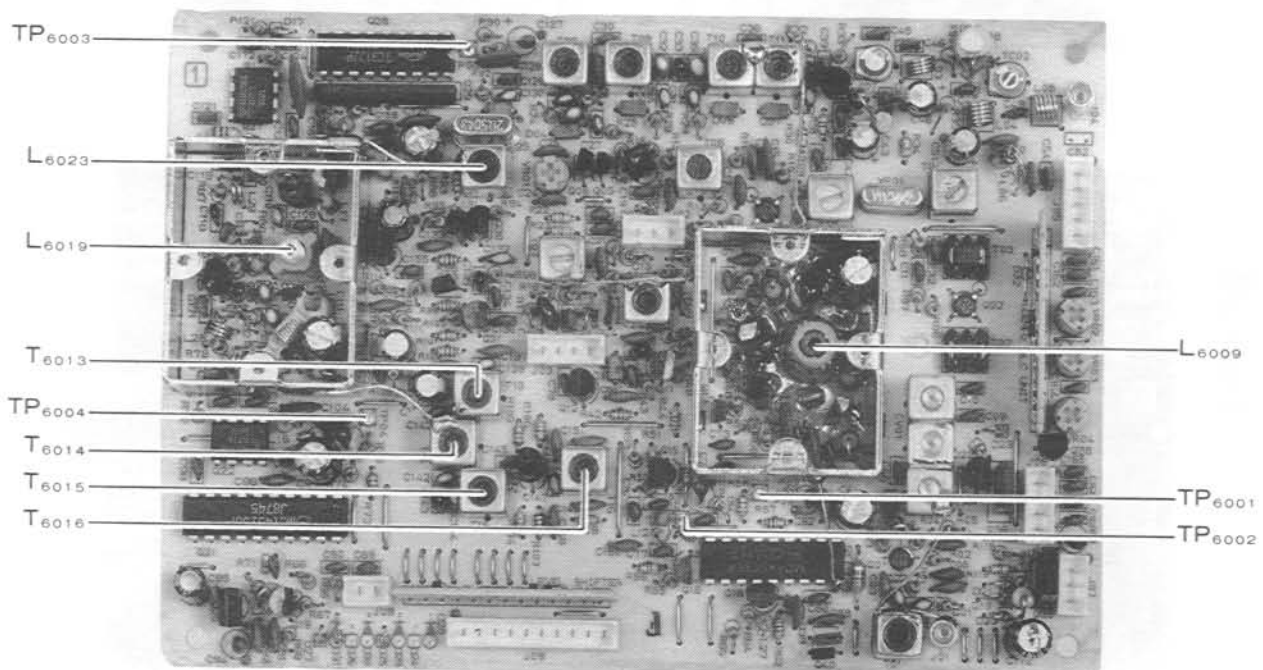

144MHz MAIN UNIT ALIGNMENT POINTS

ALIGNMENT (PLL)

F. 430 MHz PLL Sub Loop (on 430 MHz PLL Unit - requires DC voltmeter)

1. Connect the DC voltmeter between TP8001 and chassis ground.
2. Tune the transceiver to 4xx.01999 MHz, CW mode, and adjust L8004 for 4.2V on the voltmeter.
3. Retune the transceiver to 4xx.02000 MHz and confirm at least 0.6V on the voltmeter.
4. Disconnect the voltmeter.

G. 430 MHz PLL VCXO (on 430 MHz PLL Unit - requires RF voltmeter and DC voltmeter)

1. Connect the RF voltmeter to the exposed lead of R8015, and the DC voltmeter between the exposed lead of R8017 and chassis ground.

2. Tune the transceiver to 4xx.01999 MHz, CW mode.
3. Adjust T8001 for maximum RF voltage, and then adjust L8016 for 6.5V on the DC voltmeter.
4. Retune the transceiver to 4xx.02000 MHz and confirm at least 1.0V on the DC voltmeter.
5. Retune the transceiver to the center of the band, FM mode, and move the RF voltmeter to J8001.
6. Adjust T8002 and CV8001 for maximum on the RF voltmeter.
7. Disconnect the voltmeters.

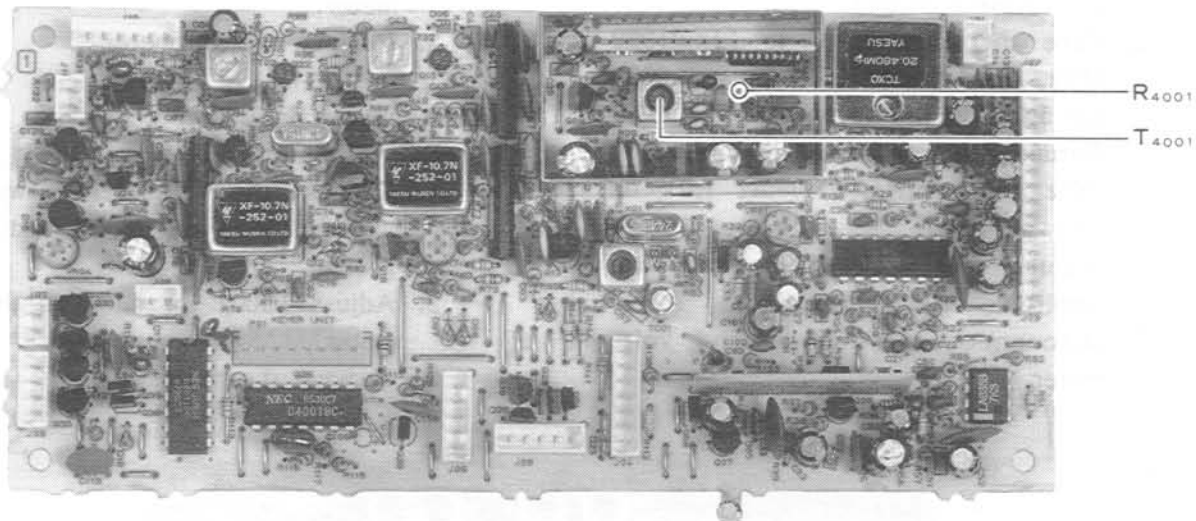

TX UNIT ALIGNMENT POINTS

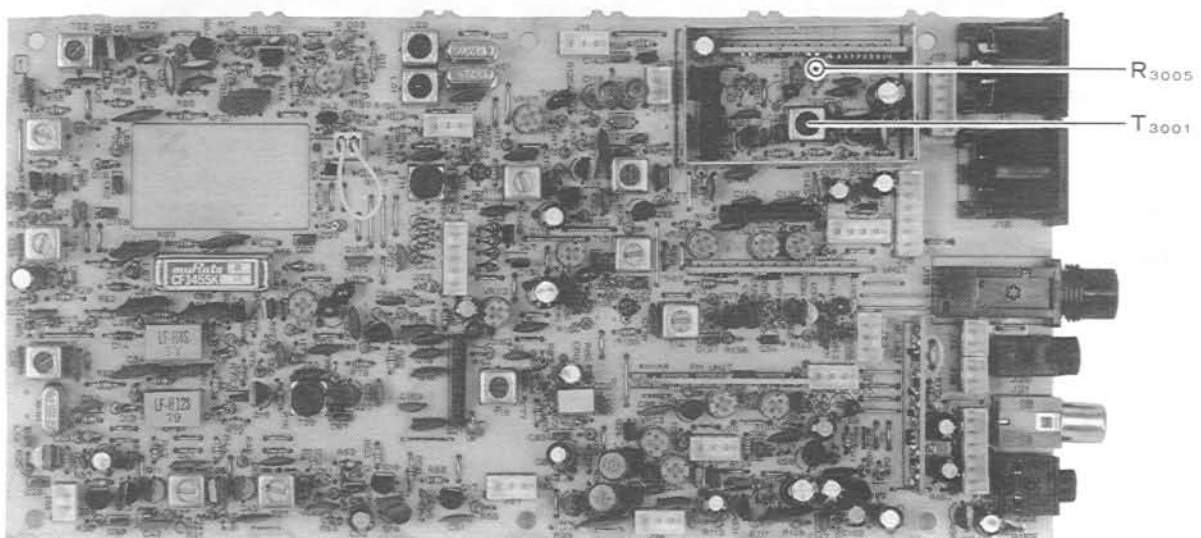

RX UNIT ALIGNMENT POINTS

(PLL) ALIGNMENT

H. 430 MHz 2nd Local (on 430 MHz Local and RF Units - requires RF and DC voltmeters)

1. Connect the DC voltmeter between the exposed lead of R7712 on the 430 MHz Local Unit and chassis ground. Connect the RF voltmeter to the exposed lead of L7029 on the 430 MHz RF Unit.
2. Set the transceiver to the center of the 70cm band, FM mode.
3. Adjust TC7701 on the 430 MHz Local Unit for 5.0V on the DC voltmeter.
4. Adjust CV7001 on the 430 MHz RF Unit for maximum on the RF voltmeter.
5. Disconnect the voltmeters.

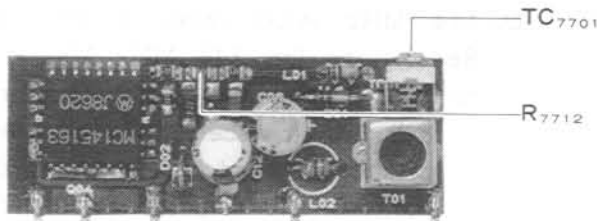

430MHz LOCAL UNIT ALIGNMENT POINTS

I. 430 MHz PLL Main Loop (on 430 MHz RF Unit - requires RF and DC voltmeters)

1. Connect the DC voltmeter between TP7001 and chassis ground. Connect the RF voltmeter to the cathode of D7010.
2. Tune the transceiver to the high edge of the 70cm band, CW mode, and adjust TC7001 for 4.0V (7.5V for versions A1 and A2) on the DC voltmeter.
3. Retune the transceiver to the low band edge and confirm at least 1.0V on the DC voltmeter.
4. Retune the transceiver to the center of the band and adjust CV7002 for peak on the RF voltmeter.
5. Retune the transceiver to the high and low band edges and confirm that the RF voltmeter reads within $\pm 1\text{dB}$ ($\pm 2\text{dB}$ for versions A1 and A2) relative to the level at the center of the band.
6. Disconnect the voltmeters.

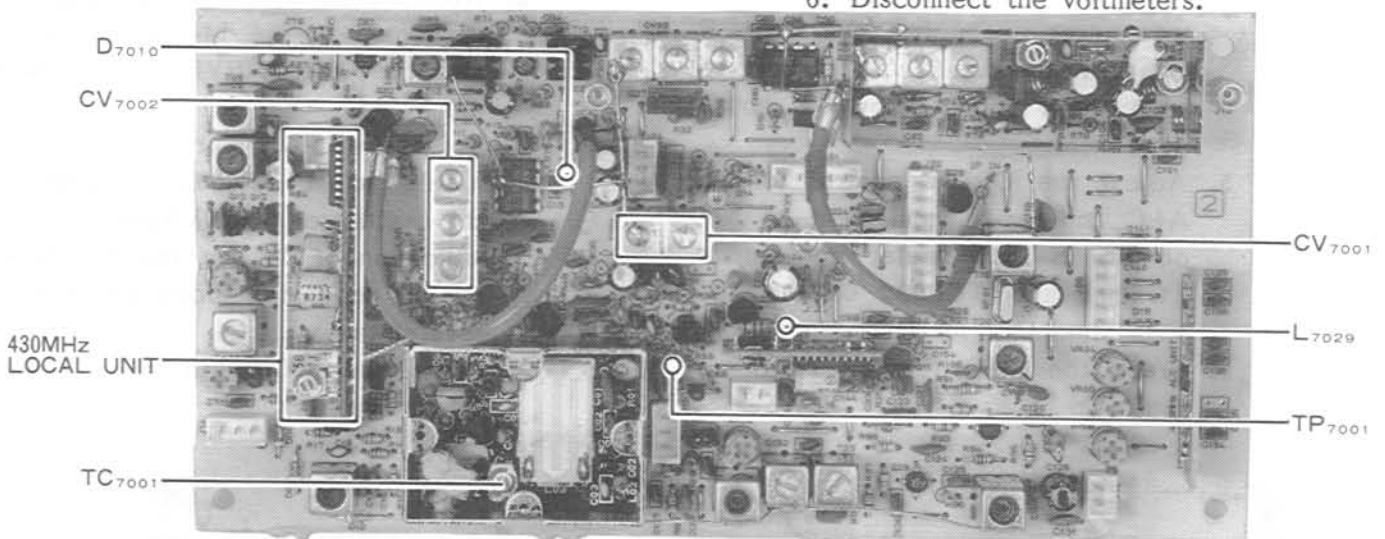

430MHz RF UNIT ALIGNMENT POINTS

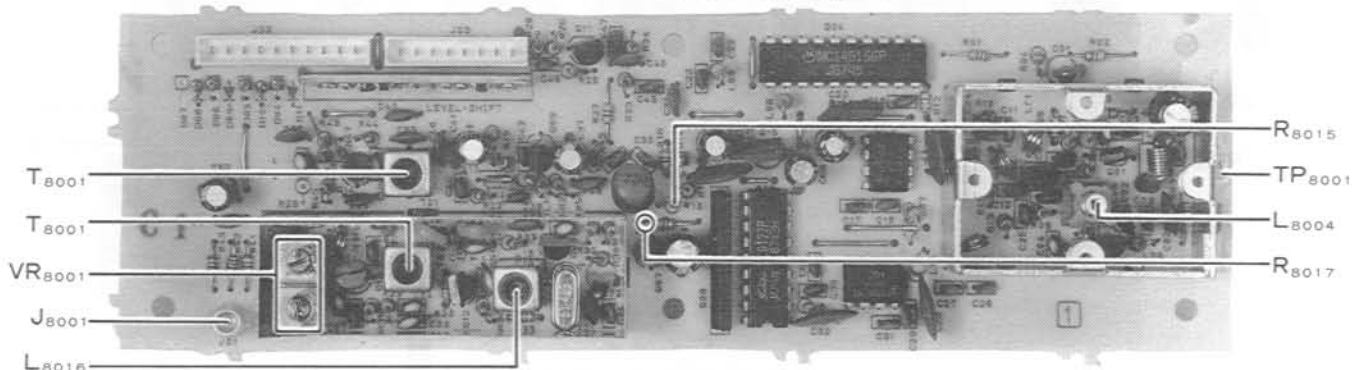

430MHz PLL UNIT ALIGNMENT POINTS

ALIGNMENT (Transmitter)

II. Transmitter

A. ALC Meter Sensitivity (on TX Unit)

1. Set the METER selector to the DISC/ALC position, and select the CW mode.
2. Tune the transceiver to the center of the 144 MHz band and adjust VR4004 so that the ALC meter just begins to deflect while receiving.

B. 144 MHz Transmitter (on TX Unit and 144 MHz Main Unit - requires dummy load, wattmeter)

1. Set the METER selector to DISC/ALC and select the FM mode.
2. Tune the transceiver to the center of the 2m band, and connect the dummy load and wattmeter to the 144 MHz antenna jack.
3. Press the MOX button and adjust the DRIVE control for 4W on the wattmeter.
4. Adjust T4002 and T4003 on the TX Unit, and T6008-T6012 on the 144 MHz Main Unit for peak on the wattmeter, reducing the DRIVE control setting if necessary to keep power output below 5W during adjustment.
5. Adjust the DRIVE control for an ALC indication equivalent to "7" on the S-Unit scale, and adjust TC6001 and TC6002 on the 144 MHz Main Unit for peak output.
6. Press the MOX button again to return to receive.

C. 144 MHz AFP (Automatic Final Protection, on 144 MHz Main Unit, requires dummy load, wattmeter and DC voltmeter)

1. Set the transceiver to the FM mode, turn the DRIVE control fully clockwise, and tune to the center of the 2m band.
2. With the dummy load and wattmeter connected to the 144 MHz antenna jack, connect the DC voltmeter to the anode of D6032.
3. Press the MOX button and adjust VR6003 for 1.0V on the voltmeter.
4. Press the MOX button to return to receive, and remove the voltmeter.

D. 144 MHz ALC level & PO Meter Sensitivity (on 144 MHz Main Unit-requires dummy load and wattmeter)

1. Set the transceiver to the center of the 2m band, FM mode, and set the METER selector to the S/PO position.
2. With the dummy load and wattmeter connected to the 144 MHz antenna jack, set the DRIVE control fully clockwise.
3. Press the MOX button and alternately adjust VR6002 for 25W on the wattmeter and VR6004 for an indication of "8" on the PO meter scale, repeating both adjustments several times.
4. Press the MOX button to return to receive.

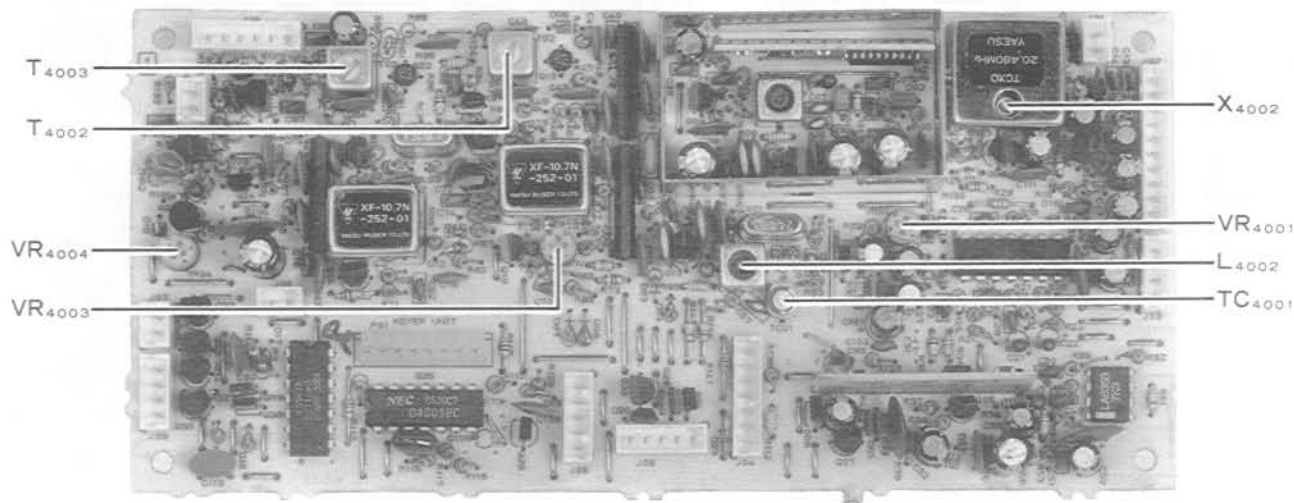

TX UNIT ALIGNMENT POINTS

(Transmitter) ALIGNMENT

E. 144 MHz FM Deviation (on TX Unit)

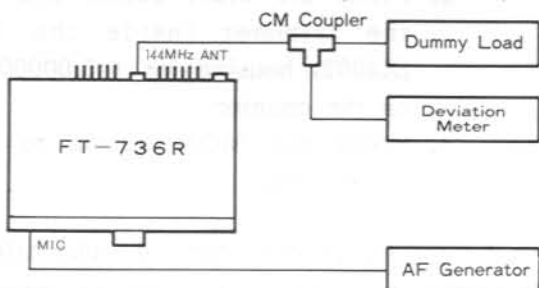

1. Connect the test equipment as shown in the diagram above.
2. In FM mode, tune the transceiver to the center of the 144 MHz band, and set the MIC Gain to 12 o'clock and DRIVE fully clockwise.
3. Set the AF generator for 15mV output at 1 kHz.
4. Press the MOX button and adjust VR4001 for ± 4.5 kHz deviation on the deviation meter.
5. Now select the FM-N mode and confirm ± 2 to ± 3 kHz deviation.
6. Press the MOX button again to return to receive.

F. SSB Carrier Point (on TX Unit- requires dummy load, wattmeter and AF generator)

1. Connect the dummy load and wattmeter to the 144 MHz antenna jack, and the AF generator to pin 8 of the MIC jack (pin 7 is ground).

2. Tune the transceiver to the center of the 2m band in USB mode. Set the MIC gain control to 12 o'clock and the DRIVE control to 9 o'clock. Press the MOX button.
3. While maintaining a constant AF injection level of 1mV, tune the AF generator back and forth between 300 and 2700 Hz while adjusting L4002 so that the power output is the same at both AF injection frequencies.
4. Change to LSB mode and repeat step 3, adjusting L4001.
5. Press the MOX button to return to receive, remove the AF generator.

G. SSB Carrier Balance (on TX Unit)

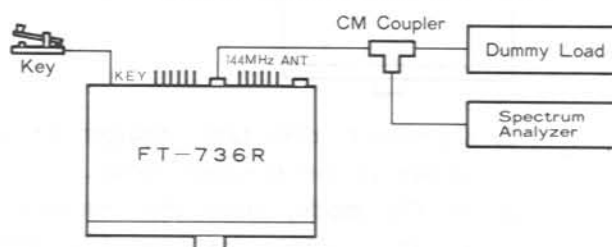

1. Connect the test equipment as shown in the diagram above.
2. In CW mode, tune the transceiver to the center of the 144 MHz band. Set the MIC Gain fully counterclockwise and DRIVE fully clockwise. Also, set the VOX gain control to 9 o'clock.

144MHz MAIN UNIT ALIGNMENT POINTS

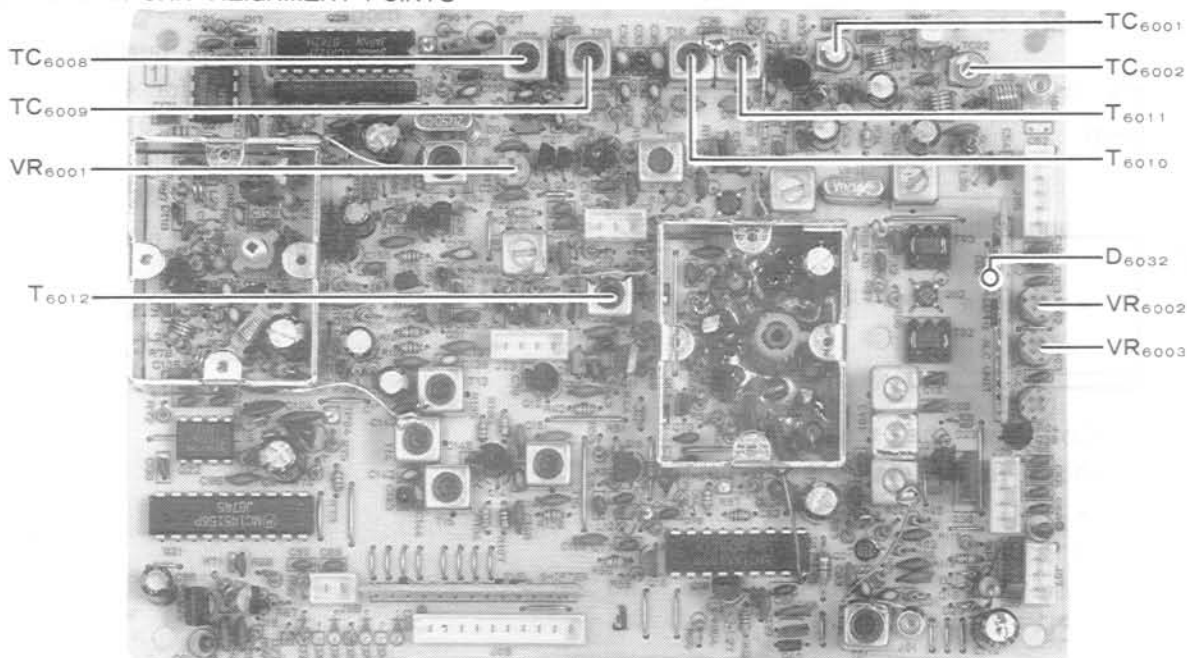

ALIGNMENT (Transmitter)

3. Close the key and note the carrier level on the analyzer. Then change to the USB mode.
4. Press the MOX button and adjust VR4003 for minimum carrier level (less than 40dB below the CW carrier level noted in step 3).
5. Change to LSB mode and confirm at least 40dB carrier suppression while transmitting.
6. Press the MOX button to return to receive.

H. 144 MHz TX Mixer (on 144 MHz Main Unit)

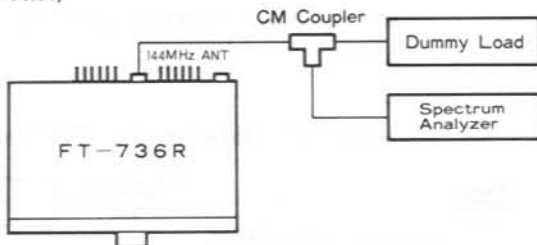

1. Connect the test equipment as shown in the diagram above.
2. In FM mode, tune the transceiver to the center of the 144 MHz band. Set the MIC Gain fully counterclockwise and DRIVE fully clockwise.
3. Press the MOX button and adjust VR6001 so that the spuri at 13.79 MHz on either side of the carrier are at least 65dB down.
4. Press the MOX button again to return to receive.

I. TX Frequency Calibration (on TX Unit)

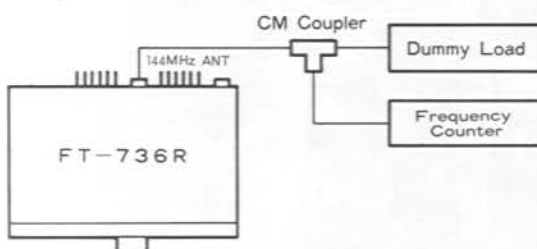

1. Connect the test equipment as shown in the diagram above.
2. In FM mode, tune the transceiver to 145.00000 MHz. Set the MIC gain fully counterclockwise and DRIVE fully clockwise.

3. Press the MOX button and adjust the trimmer inside the TCXO (X4002) housing for 145.00000 MHz on the counter.
4. Press the MOX button to return to receive.

J. 430 MHz TX RF (on 430 MHz RF Unit - requires tracking generator and spectrum analyzer)

1. Connect the tracking generator to J7009 on the 430 MHz Main Unit, and couple the spectrum analyzer to the 430 MHz antenna jack.
2. Set the tracking generator output to -30dBm and adjust CV7003, CV7004, TC7002 and TC7003 for the passband shown (reducing injection level, if necessary, to avoid saturation).

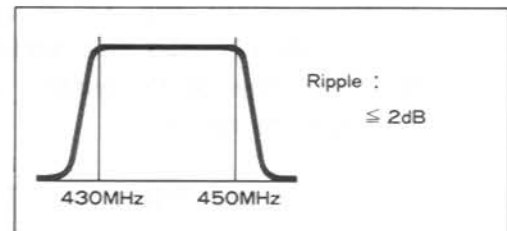

K. 430 MHz TX IF, Part I (on 430 MHz RF Unit - requires dummy load and wattmeter)

1. With the dummy load and wattmeter connected to the 430 MHz antenna jack, tune the transceiver to the center of the 70cm band, FM mode.
2. Press the MOX button and set the DRIVE control for 4W output.
3. Adjust T7006-T7010 for maximum deflection on the wattmeter (but do not exceed 5W output: reduce the DRIVE control setting, if necessary).
4. Press the MOX button again to return to receive.

(Transmitter) ALIGNMENT

L. 430 MHz AFP (Automatic Final Protection, on 430 MHz RF Unit -requires dummy load and DC voltmeter)

1. With the dummy load connected to the 430 MHz antenna jack, connect the DC voltmeter to the jumper wire (marked "A" in the drawing below) on the 430 MHz RF Unit.
2. Set the transceiver to FM, band center. Set the DRIVE control fully clockwise, and set the METER selector to S/PO. Press the MOX button.
3. Adjust VR7005 for 1.0V on the DC voltmeter.
4. Press the MOX button again to return to receive, and remove the voltmeter.

M. 430 MHz ALC and PO Meter Sensitivity (on 430 MHz RF Unit -requires dummy load and wattmeter)

1. With the dummy load connected to the 430 MHz antenna jack, set the transceiver to FM, band center. Set the DRIVE control fully clockwise, and set the METER selector to S/PO.
2. Press the MOX button and alternately adjust VR7004 for 25W output and VR7006 so the transceiver meter deflects to "8" on the PO scale.

3. Repeat the adjustments in step 2 several times, and then press the MOX button again to return to receive.

N. 430 MHz TX Mixer (on 430 RF Unit)

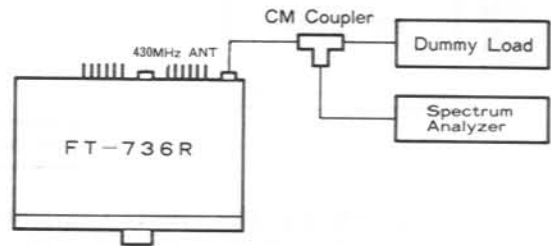

1. Connect the test equipment as shown in the diagram above.
2. Tune the transceiver to the center of the 70cm band, FM mode. Set the MIC gain fully counterclockwise and DRIVE fully clockwise.
3. Press the MOX button and adjust VR7002 so that the spuri at 13.79 MHz on either side of the carrier are at least 65dB down.
4. Press the MOX button again to return to receive.

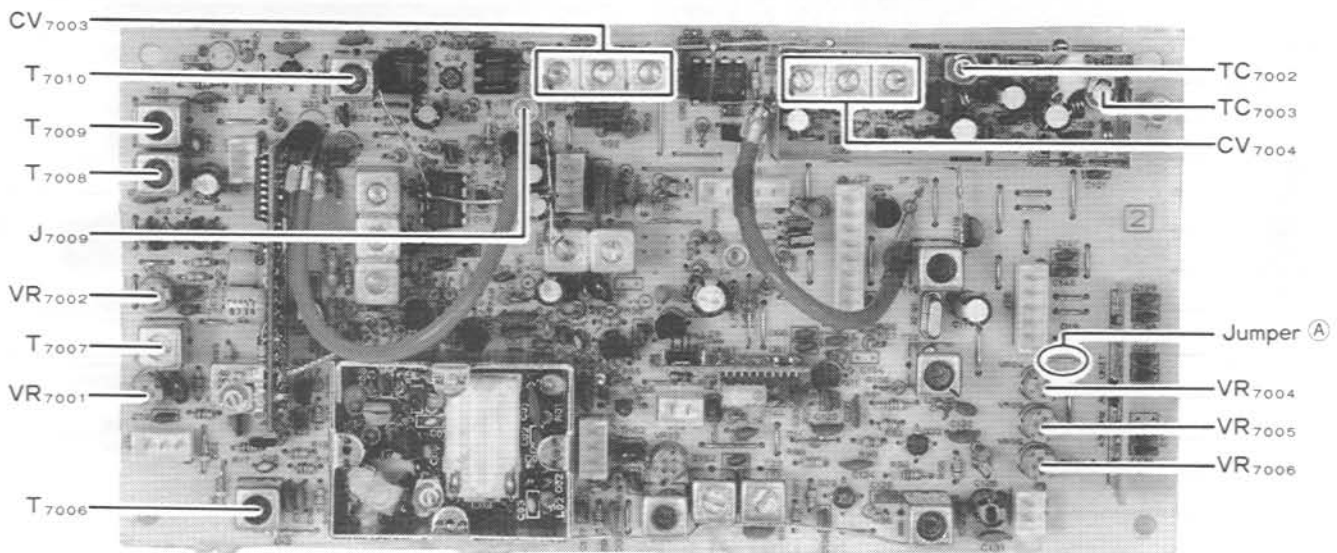

430MHz RF UNIT ALIGNMENT POINTS

ALIGNMENT (Transmitter Receiver)

O. 430 MHz TX IF, Part II (on 430 MHz RF Unit)

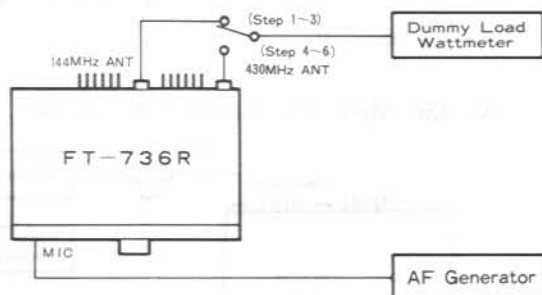

1. Connect the test equipment as shown above, with the AF generator set for 3mV @ 1 kHz.
2. Set the transceiver to USB, at the center of the 144 MHz band.
3. Set the DRIVE control fully clockwise, press the MOX button to transmit, and adjust the MIC gain for 5W output. Press the MOX button again to return to receive.
4. Retune the transceiver, now to the center of the 430 MHz band.
5. Press the MOX button and adjust VR7001 for 5W output.
6. Press the MOX button to return to receive, and disconnect the test equipment.

III. Receiver

A. IF Shift (on RX Unit - requires frequency counter)

1. Connect the counter to jumper "A" in the diagram below.
2. Tune the transceiver to the center of the 430 MHz band, USB mode, and set the SHIFT control to 12 o'clock.
3. Adjust L3001 for 13.2335 MHz \pm 50 Hz on the counter.
4. Confirm at least \pm 1 kHz shift on the counter when the SHIFT control is set to its extremes.
5. Center the SHIFT control and select the LSB mode.
6. Adjust L3002 for 13.2365 MHz \pm 50 Hz on the counter.
7. Repeat step 4.
8. Center the SHIFT control and select the CW mode.
9. Adjust VR3012 for 13.2350 MHz \pm 50 Hz on the counter. In CW mode the counter frequency should not change when the SHIFT control is turned.
10. Disconnect the counter.

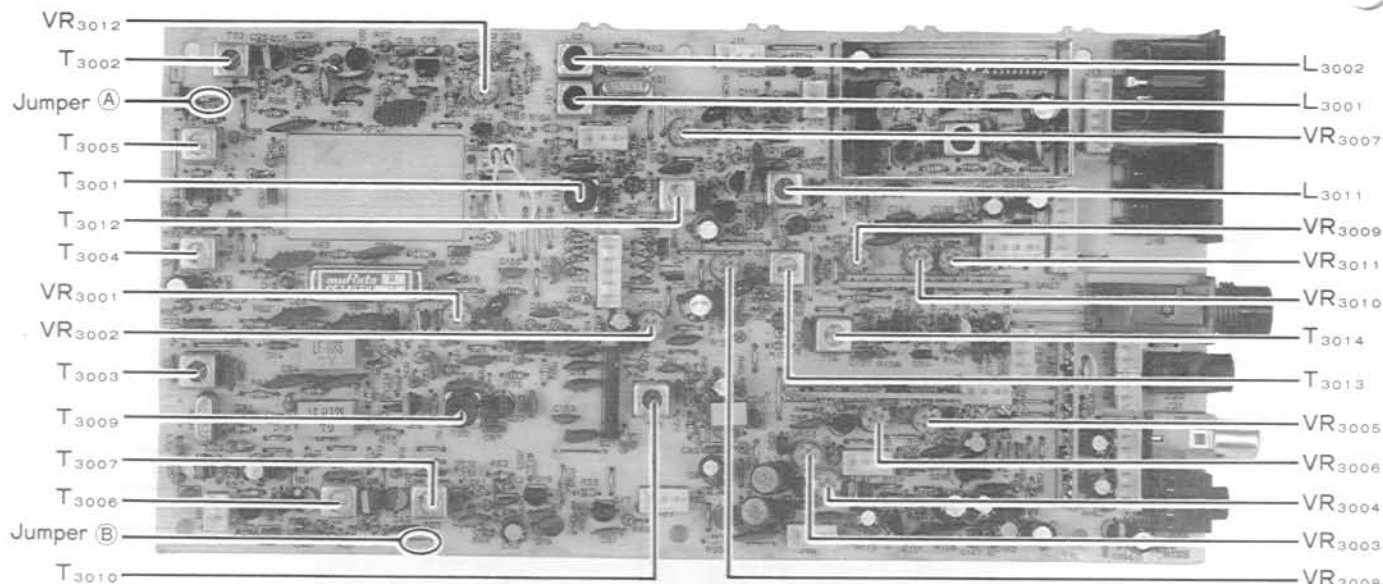

RX UNIT ALIGNMENT POINTS

(Receiver) ALIGNMENT

B. 144 MHz RX (on RX Unit and 144 MHz Main Unit)

1. Connect the test equipment as shown here.

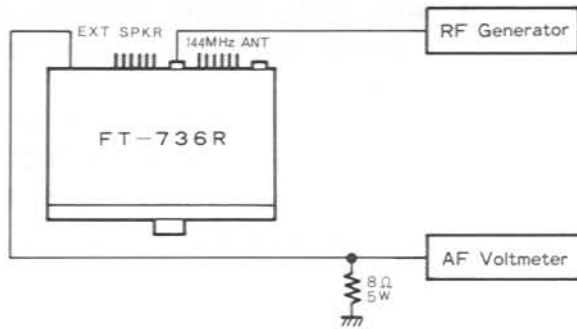

2. Set the transceiver to FM mode, the METER selector to S/PO, AF gain to 10 o'clock and RF gain fully clockwise.
3. Tune the transceiver and RF generator to the center of the 2m band. Inject a 1 kHz tone with ± 7 kHz deviation at a level sufficient to produce an S-7 reading on the S-meter.
4. Adjust T6001, CV6001 and T6004-T6006 on the 144 MHz RX Unit, and T3002-T3005 and T3009 on the RX Unit for peak S-meter deflection.
5. Adjust T3010 on the RX Unit for maximum deflection on the AF voltmeter.
6. Repeat steps 4 and 5 several times.

7. Change to mode to USB and turn off the RF generator's injection modulation.
8. Tune the transceiver for a 1.5 kHz heterodyne on the injected carrier, and adjust the injection level for S-7 on the S-meter.
9. Adjust T3011-T3014 on the RX Unit for maximum deflection on the AF voltmeter, reducing the injection level if necessary to maintain an S-7 indication on the S-meter.
10. Remove the test equipment.

C. Noise Squelch (RX Unit - requires RF generator)

1. With the RF generator connected to the 144 MHz antenna jack and switched off, set the transceiver to FM, and set the SQL and RF gain controls fully clockwise.
2. Tune the transceiver to the center of the 2m band and turn the SQL control counterclockwise just until the squelch opens, which should be around 9 o'clock.
3. Set the SQL control to 9 o'clock and adjust VR3003, if necessary, to the point just before the squelch opens with no RF injection.

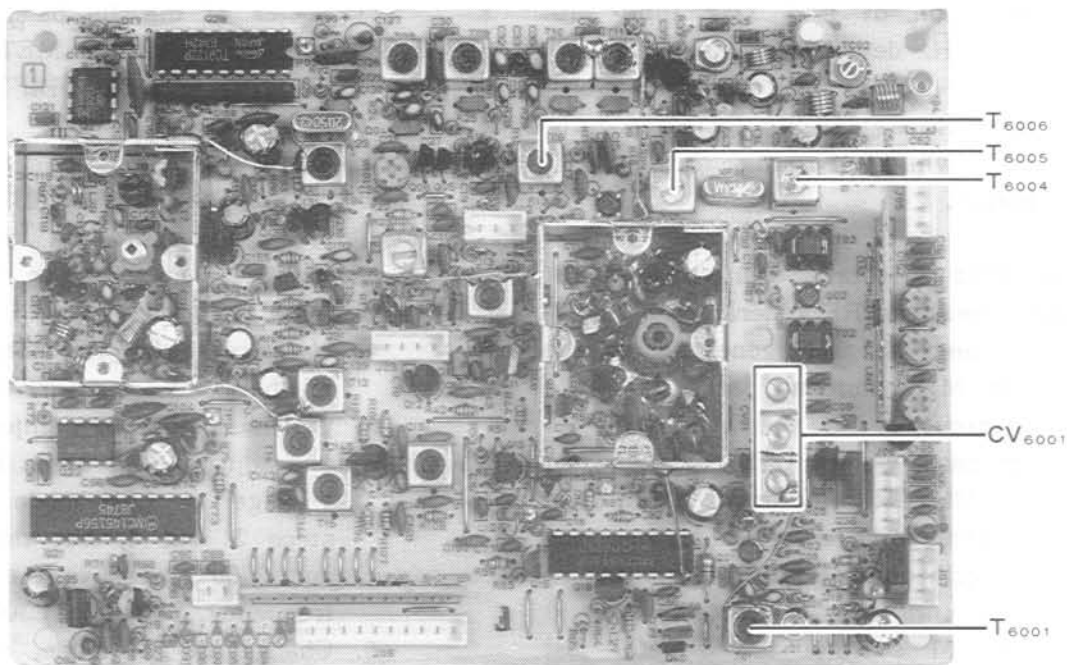

144MHz MAIN UNIT ALIGNMENT POINTS

ALIGNMENT (Receiver)

4. Set the RF generator for ± 3.5 kHz deviation of a 1 kHz tone at the same frequency as the transceiver, and confirm that the squelch opens with less than -12dBu injection when the SQL control is at 9 o'clock.
 5. Turn off the RF generator, move the SQL control to 10 o'clock, select USB mode and adjust VR3009 so the squelch is just closed.
 6. Adjust the frequency of the RF generator (with no modulation) for a 1.5 kHz heterodyne in the receiver, and reduce the injection level to confirm that the squelch opens with less than 0dBu injection.
 7. Return to FM mode and turn the SQL control fully clockwise. Retune the RF generator to the transceiver frequency, and modulate with ± 3.5 kHz of a 1 kHz tone.
 8. Confirm that the squelch just opens with an injection level of 0dBu ± 5 dB.
- D. Digital Squelch (on RX Unit - requires RF generator)
1. Connect the RF generator to the 144 MHz antenna jack and tune it and the transceiver to the center of the 2m band, FM mode.
 2. Set the RF generator for -11 dBu injection of a 1 kHz tone with ± 3.5 kHz deviation.
 3. Adjust VR3004 so that the squelch just closes (BUSY indicator turns off) while pressing the RESET button.
- E. 144 MHz S-Meter Sensitivity (on RX Unit - requires RF generator)
1. Connect the RF generator to the 144 MHz antenna jack. Tune the transceiver to the center of the 2m band. Select USB mode and set the METER selector to S/PO, SQL control fully counterclockwise and RF gain control fully clockwise.
 2. With no RF injection, adjust VR3011 so that the S-meter just begins to deflect.
 3. Inject a 20dBu carrier (with no modulation), and tune the generator to produce a 1.5 kHz heterodyne in the receiver.
 4. With 20dBu carrier injection, adjust VR3010 for S-9 indication on the S-meter.
 5. Reduce the injection level to 0dBu and adjust VR3008 for S-2 indication. Then repeat step 4 and this step several times.
 6. Select the FM mode, and retune the RF generator to the same frequency as the transceiver (band center). Modulate the alignment signal with ± 3.5 kHz deviation of a 1 kHz tone.
 7. Inject 60dBu and adjust VR3002 for full scale S-meter deflection.
 8. Reduce the injection level to 10dBu and adjust VR3001 for S-7 deflection.
 9. Repeat steps 7 and 8 several times.
- F. RX Carrier Point (on RX Unit - requires RF signal generator and frequency counter)
1. Connect the RF generator to the 144 MHz antenna jack, and the counter to jumper "B" in the diagram on the page 64.
 2. With the transceiver tuned to the center of the 2m band, select the USB mode, set the METER selector to S/PO and the SHIFT control to 12 o'clock.
 3. Tune the RF generator 300 Hz below the displayed transceiver frequency, and set the injection for S-9 indication on the S-meter (with no modulation).
 4. Now tune the RF generator 2700 Hz below the transceiver frequency (without changing injection level) and adjust L3001 again for S-9.
 5. Change to LSB mode and repeat steps 3 and 4, but this time 300 and 2700 Hz above the transceiver frequency, adjusting L3002.
 6. Change to FM mode, turn off the RF generator and adjust VR3012 for 13.2350 MHz ± 50 Hz on the counter.

(Receiver) ALIGNMENT

7. Disconnect the counter.
- G. DISC Meter (on RX Unit - requires RF generator)
1. With the RF generator connected to the 144 MHz antenna jack, tune the transceiver and RF generator to the center of the 2m band, select the FM mode, and set the METER selector to DISC/ALC.
 2. With 20dBu injection of a 1 kHz tone with ± 3.5 kHz deviation, adjust VR3006 so that the meter deflects to the center ("5" on the PO scale).
- H. Scanner Center Stop (on RX Unit - requires RF generator)
1. With the RF generator connected to the 144 MHz antenna jack and set for 20dBu injection with no modulation, tune the transceiver and RF generator to the center of the 2m band, select the FM mode, and set the SQL and RF gain controls fully clockwise.
 2. Tune the RF generator frequency back and forth slightly while watching the BUSY indicator, noting the frequencies above and below the transceiver frequency at which the indicator turns off.
 3. Calculate the offsets of these frequencies from the frequency displayed on the transceiver. If these are not the same, adjust VR3005 and repeat step 2 until they are.
- I. Notch Filter (on RX Unit, requires RF generator)
1. With the RF generator connected to the 144 MHz antenna jack, set for 5dBu injection with no modulation.
 2. Tune the transceiver to the center of the 2m band, select the USB mode, and set the following controls:
 - a. METER selector to S/PO
 - b. SQL control fully clockwise
 - c. RF gain fully clockwise
 - d. AF gain to 10 o'clock
 - e. NOTCH control to 12 o'clock
 - f. NOTCH button ON (depressed)
 3. Tune the RF generator 1.5 kHz above the receiver frequency and adjust L3011 for minimum S-meter deflection. Then adjust VR3007 for best null of the 1.5 kHz heterodyne in the loudspeaker.
- J. Noise Blanker (on RX Unit - requires RF generator and DC voltmeter)
1. With the RF generator connected to the 144 MHz antenna jack, connect the DC voltmeter to point "B" in the diagram on the page 64.
 2. Tune the transceiver and RF generator to the center of the 2m band, and inject a 20dBu carrier with no modulation.
 3. Select the USB mode, set the RF gain fully clockwise and adjust T3006 and T3007 for minimum deflection on the voltmeter.
 4. Disconnect the voltmeter.
- K. 144 MHz Receiver Overall Check
1. Connect the test equipment as shown below.

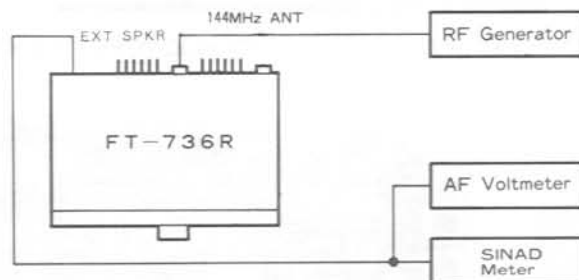

2. Select FM mode, set the METER selector to S/PO, SQL fully counterclockwise, AF gain to 10 o'clock and RF gain fully clockwise.
3. Tune the transceiver and RF generator to the center of the 2m band and set the injection level for S-9 indication with ± 3.5 kHz deviation of a 1 kHz tone.

ALIGNMENT (Receiver)

4. Tune the transceiver and RF generator to the high and low band edges and confirm that the injection level required for S-9 indication is within $\pm 3\text{dB}$ of that at band center.
 5. Retune the transceiver and RF generator to band center, and confirm that 12dB SINAD is better than -9dB.
 6. Select the USB mode and set the injection level to -10dB with no modulation. Confirm at least 12dB (S+N)/N.
 7. Remove the test equipment.
- L. 430 MHz RX RF (on 430 MHz Front End Unit - requires tracking generator and spectrum analyzer)
1. Connect the tracking generator to J7801 and the analyzer to J7082. Set the tracking generator level to about -30dBm, and reduce it if necessary to avoid saturation.
 2. Adjust TC7801 and CV7801 for less than $\pm 5\text{dB}$ ripple between 430 and 450 MHz.
- M. 430 MHz RX IF (on 430 MHz RX Unit - requires RF generator)
1. Connect the RF generator to the 430 MHz antenna jack.
 2. Set the transceiver to FM, METER selector to S/PO and RF gain fully clockwise.
 3. Tune the RF generator and transceiver to the center of the 70cm band, and inject $\pm 7\text{ kHz}$ deviation of a 1 kHz tone at a level sufficient to produce S-7 deflection on the S-meter.
 4. Adjust T7019-T7024 for peak S-meter deflection.
- N. 430 MHz Module Gain (on 430 MHz RX Unit - requires RF generator)
1. Connect the RF generator to the 430 MHz antenna jack.
 2. Set the transceiver to USB, METER selector to S/PO and RF gain fully clockwise.
 3. Tune the transceiver to the center of the 70cm band.
 4. Inject a 20dBu carrier with no modulation 1.5 kHz above the transceiver frequency, and adjust VR7003 for S-9 deflection on the S-meter.

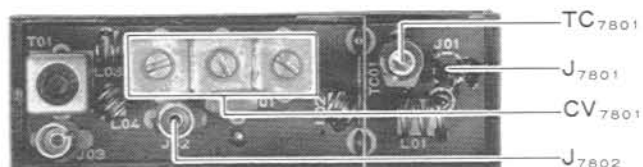

430MHz FRONTEND UNIT ALIGNMENT POINTS

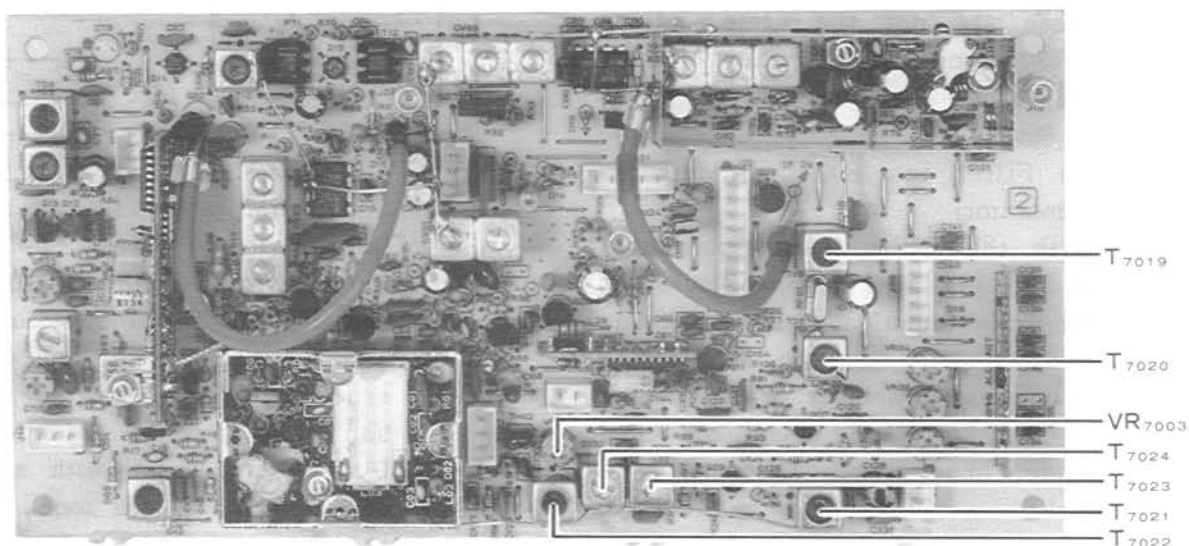

430MHz RX UNIT ALIGNMENT POINTS

O. 430 MHz Receiver Overall Check

1. Connect the test equipment as shown below.

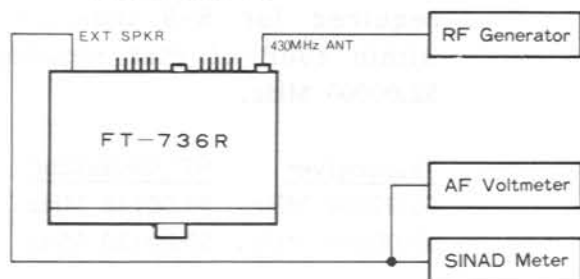

2. Select the FM mode, set the METER selector to S/PO, SQL fully counterclockwise, AF gain to 10 o'clock and RF gain fully clockwise.
3. Tune the transceiver and RF generator to the center of the 70cm band and set the injection level for S-9 indication with ± 3.5 kHz deviation of a 1 kHz tone.
4. Tune the transceiver and RF generator to the high and low band edges and confirm that the injection level required for S-9 indication is within ± 3 dB of that at band center.
5. Retune the transceiver and RF generator to band center, and confirm that 12dB SINAD is better than -9dB.
6. Select the USB mode and set the injection level to -10dB with no modulation. Confirm at least 12dB (S+N)/N.
7. Remove the test equipment.

IV. FEX-736-50

- A. 50 MHz PLL Sub Loop (on 50 MHz PLL Unit - requires oscilloscope and DC voltmeter)

1. Connect the 'scope to TP1001 and the DC voltmeter between TP1002 and chassis ground.
2. Tune the transceiver to 52.00000 MHz, CW mode, and adjust T1002-T1005 for maximum amplitude on the 'scope.
3. Retune the transceiver to 52.01999 MHz and adjust L1016 for 4.2V on the voltmeter.
4. Retune the transceiver to 52.02000 MHz and confirm at least 0.6V on the voltmeter.
5. Disconnect the 'scope and voltmeter.

- B. 50 MHz PLL VCXO (on 50 MHz PLL Unit - requires DC voltmeter)

1. Connect the voltmeter between the exposed lead of R1055 and chassis ground.
2. Tune the transceiver to 52.01999 MHz, CW mode, and adjust L1009 for 6.0V on the voltmeter.
3. Retune the transceiver to 52.02000 MHz and confirm at least 1.0V on the voltmeter.
4. Disconnect the voltmeter.

- C. 50 MHz PLL Main Loop (on 50 MHz PLL Unit - requires DC and RF voltmeters)

1. Connect the DC voltmeter between the exposed lead of R1022 and chassis ground. Connect the RF voltmeter to pin 1 of J1001.
2. Tune the transceiver to 53.99999 MHz, CW mode, and adjust L1003 for 6.0V on the voltmeter.
3. Retune the transceiver to 50.00000 MHz and confirm at least 2.0V on the DC voltmeter.
4. Retune the transceiver to 52.00000 MHz and adjust T1001 for maximum on the RF voltmeter.
5. Disconnect the voltmeters.

ALIGNMENT (FEX-736-50)

D. 50 MHz RX (on 50 RF Unit - require RF generator)

1. Connect the RF generator to the 50 MHz antenna jack.
2. Set the transceiver to FM mode, the METER selector to S/PO and RF gain fully clockwise.
3. Tune the transceiver and RF generator to 52.00000 MHz. Inject a 1 kHz tone with ± 7 kHz deviation at a level sufficient to produce an S-7 reading on the S-meter.
4. Adjust T2001-T2004 and T2007-T2009 for peak S-meter deflection.

E. 50 MHz Module Gain (on 50 MHz RF Unit - requires RF generator)

1. Connect the RF generator to the 50 MHz antenna jack.
2. Set the transceiver to USB, METER selector to S/PO and RF gain fully clockwise.
3. Tune the transceiver to 52.00000 MHz.
4. Inject a 20dBu carrier with no modulation 1.5 kHz above the transceiver frequency, and adjust VR2001 for S-9 deflection on the S-meter.

5. Tune the transceiver and RF generator as indicated below, and confirm that the injection level required for S-9 indication is within ± 3 dB of that required at 52.00000 MHz.

Transceiver	RF Generator
53.99999 MHz	54.00149 MHz
50.00000 MHz	50.00150 MHz

F. 50 MHz Receiver Overall Check

1. Connect the test equipment as shown below.

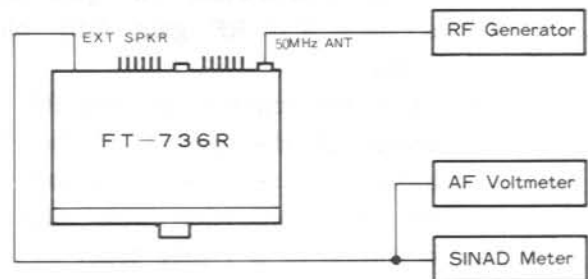

2. Select the FM mode, set the METER selector to S/PO, SQL fully counterclockwise, AF gain to 10 o'clock and RF gain fully clockwise.
3. Tune the transceiver and RF generator to 52.00000 MHz. Inject a 1 kHz tone with ± 3.5 kHz deviation, and confirm a 12dB SINAD of -9dB or better.

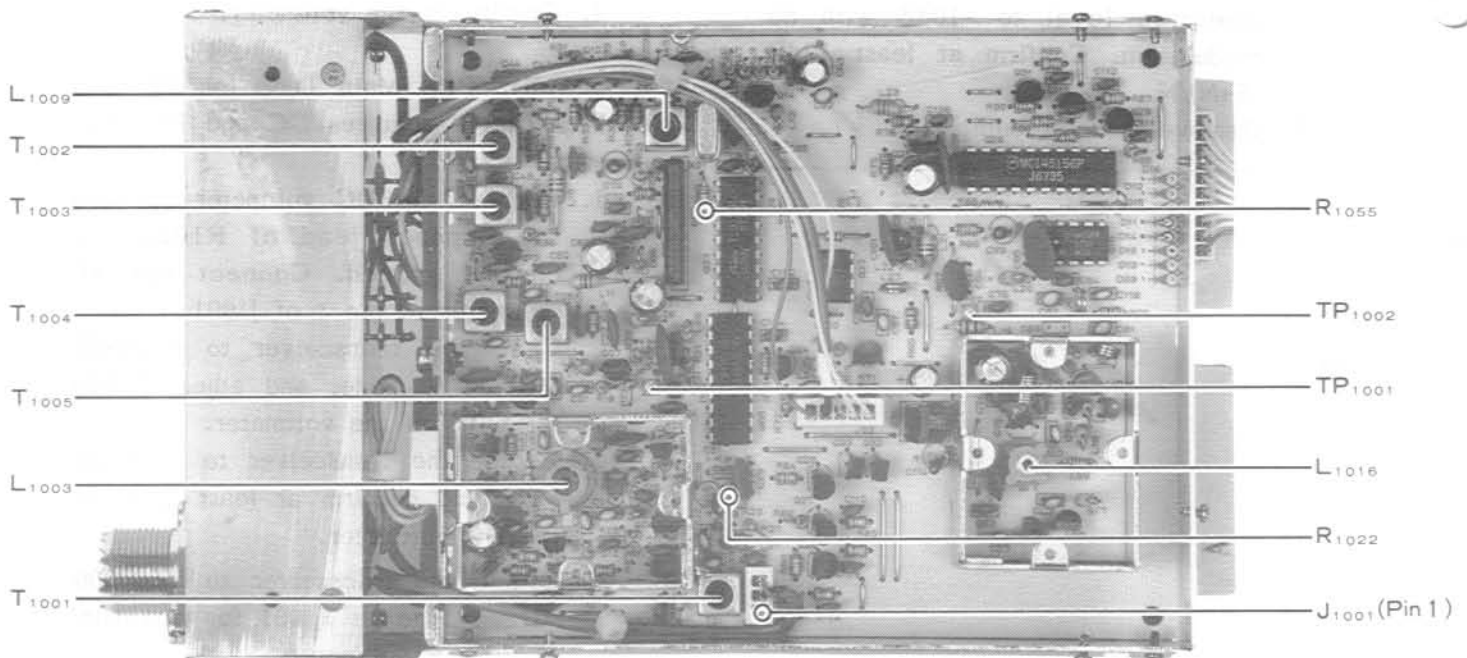

50MHz PLL UNIT ALIGNMENT POINTS

(FEX-736-50) ALIGNMENT

4. Select the USB mode and set the injection level to -10dB with no modulation. Confirm at least 12dB (S+N)/N.
5. Remove the test equipment.

G. 50 MHz TX IF, Part I (on 50 MHz RF Unit - requires dummy load and wattmeter)

1. With the dummy load and wattmeter connected to the 50 MHz antenna jack, tune the transceiver to 52.00000 MHz, FM mode.
2. Press the MOX button and set the DRIVE control for 4W output.
3. Adjust T2010-T2013 and TC2001 for peak on the wattmeter, reducing the DRIVE control setting, if necessary, to keep power output below 5W during adjustments.
4. Press the MOX button again to return to receive.

H. 50 MHz AFP (Automatic Final Protection, on 50 MHz RF Unit, requires dummy load, wattmeter and DC voltmeter)

1. Set the transceiver to the FM mode, turn the DRIVE control fully clockwise, and tune to 52.00000 MHz.

2. With the dummy load and wattmeter connected to the 50 MHz antenna jack, connect the DC voltmeter to the anode of D2019.
3. Press the MOX button and adjust VR2004 for 1.0V on the voltmeter.
4. Press the MOX button to return to receive, and remove the voltmeter.

I. 50 MHz ALC level & PO Meter Sensitivity (on 50 MHz RF Unit - requires dummy load and wattmeter)

1. Set the transceiver to 52.00000 MHz, FM mode, and set the METER selector to the S/PO position.
2. With the dummy load and wattmeter connected to the 50 MHz antenna jack, set the DRIVE control fully clockwise.
3. Press the MOX button and alternately adjust VR2005 for 10W on the wattmeter and VR2006 for an indication of "8" on the PO meter scale, repeating both adjustments several times.
4. Press the MOX button to return to receive.

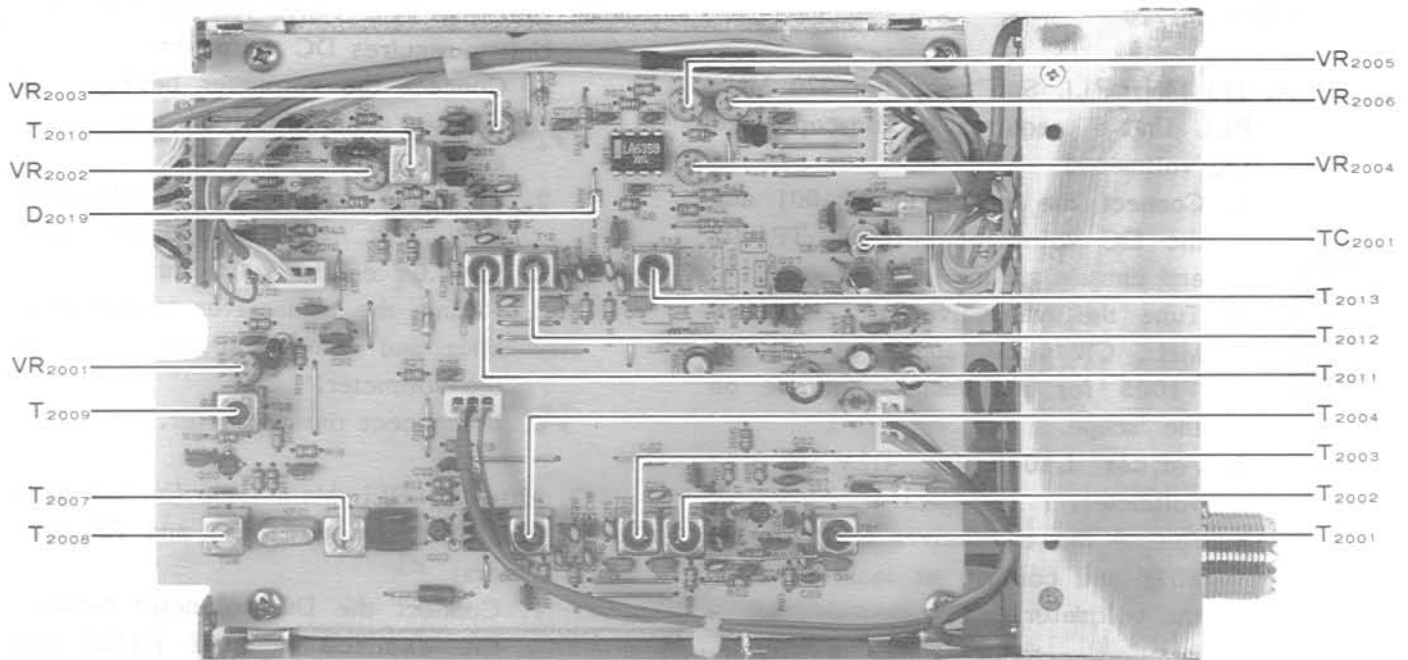

50MHz RF UNIT ALIGNMENT POINTS

ALIGNMENT (FEX-736-50) (FEX-736-220)

J. 50 MHz TX Mixer (on 50 MHz RF Unit)

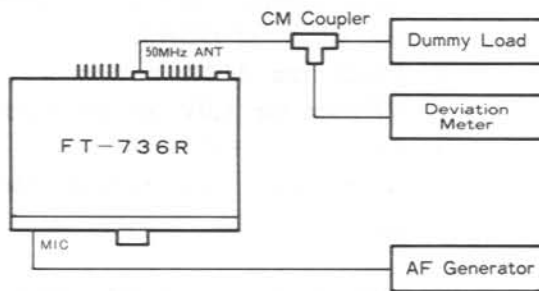

1. Connect the test equipment as shown in the diagram above.
2. In FM mode, tune the transceiver to 52.00000 MHz, FM mode. Set the MIC Gain fully counterclockwise and DRIVE fully clockwise.
3. Press the MOX button and adjust VR2003 so that the spurs at 13.79 MHz on either side of the carrier are at least 65dB down.
4. Press the MOX button again to return to receive.

K. 50 MHz TX IF, Part II (on 50 MHz RF Unit)

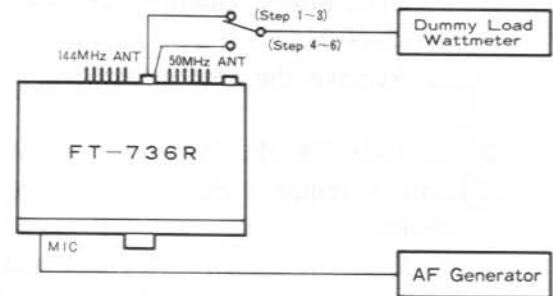

1. Connect the test equipment as shown above, with the AF generator set for 3mV @ 1 kHz.
2. Set the transceiver to USB, at the center of the 144 MHz band.
3. Set the DRIVE control fully clockwise, press the MOX button to transmit, and adjust the MIC gain for 5W output. Press the MOX button again to return to receive.
4. Retune the transceiver to 52.00000 MHz.
5. Press the MOX button and adjust VR2002 for 5W output.
6. Press the MOX button to return to receive, and disconnect the test equipment.

V. FEX-736-220

A. 220 MHz PLL Sub Loop (on 220 MHz PLL Unit - requires oscilloscope and DC voltmeter)

1. Connect the 'scope to TP1001 and the DC voltmeter between TP1002 and chassis ground.
2. Tune the transceiver to 222.01999 MHz, CW mode, and adjust T1002-T1005 for maximum amplitude on the 'scope.
3. Adjust L1016 for 4.2V on the voltmeter.
4. Retune the transceiver to 222.02000 MHz and confirm at least 0.6V on the voltmeter.
5. Disconnect the 'scope and voltmeter.

B. 220 MHz PLL VCXO (on 220 MHz PLL Unit - requires DC voltmeter)

1. Connect the voltmeter between the exposed lead of R1055 and chassis ground.
2. Tune the transceiver to 222.01999 MHz, CW mode, and adjust L1009 for 6.0V on the voltmeter.
3. Retune the transceiver to 222.02000 MHz and confirm at least 1.0V on the voltmeter.
4. Disconnect the voltmeter.

C. 220 MHz PLL Main Loop (on 220 MHz PLL Unit - requires DC and RF voltmeters)

1. Connect the DC voltmeter between the exposed lead of R1022 and chassis ground. Connect the RF voltmeter to pin 1 of J1001.

(FEX-736-220) ALIGNMENT

2. Tune the transceiver to 224.99999 MHz, CW mode, and adjust L1003 for 6.0V on the voltmeter.
 3. Retune the transceiver to 220.00000 MHz and confirm at least 2.0V on the DC voltmeter.
 4. Retune the transceiver to 222.50000 MHz and adjust T1001 for maximum on the RF voltmeter.
 5. Disconnect the voltmeters.
- D. 220 MHz RX (on 220 RF Unit - requires tracking generator and spectrum analyzer)
1. Connect the tracking generator to the 220 MHz antenna jack and the analyzer to J2008. Set the tracking generator level to about -30dBm, reducing the level during adjustment, if necessary, to avoid saturation.
 2. Adjust T2001 and CV2001 for less ± 3 dB ripple between 220 and 225 MHz.
 3. Remove the test equipment.
- E. 220 MHz 2nd Local (on 220 MHz RF Unit - requires oscilloscope)
1. Connect the 'scope to the anode of D2002.
 2. Adjust T2016-T2018 for maximum amplitude on the 'scope.

3. Remove the 'scope.
- F. 220 MHz RX IF (on 220 MHz RF Unit - requires RF generator)
1. Connect the RF generator to the 220 MHz antenna jack.
 2. Set the transceiver to FM, METER selector to S/PO and RF gain fully clockwise.
 3. Tune the RF generator and transceiver to 222.50000 MHz, and inject ± 7 kHz deviation of a 1 kHz tone at a level sufficient to produce S-7 deflection on the S-meter.
 4. Adjust T2004-T2009 for peak S-meter deflection.
- G. 220 MHz Module Gain (on 220 MHz RF Unit - requires RF generator)
1. Connect the RF generator to the 220 MHz antenna jack.
 2. Set the transceiver to USB, METER selector to S/PO and RF gain fully clockwise.
 3. Tune the transceiver to 222.50000 MHz.
 4. Inject a 20dBu carrier with no modulation 1.5 kHz above the transceiver frequency, and adjust VR2001 for S-9 deflection on the S-meter.

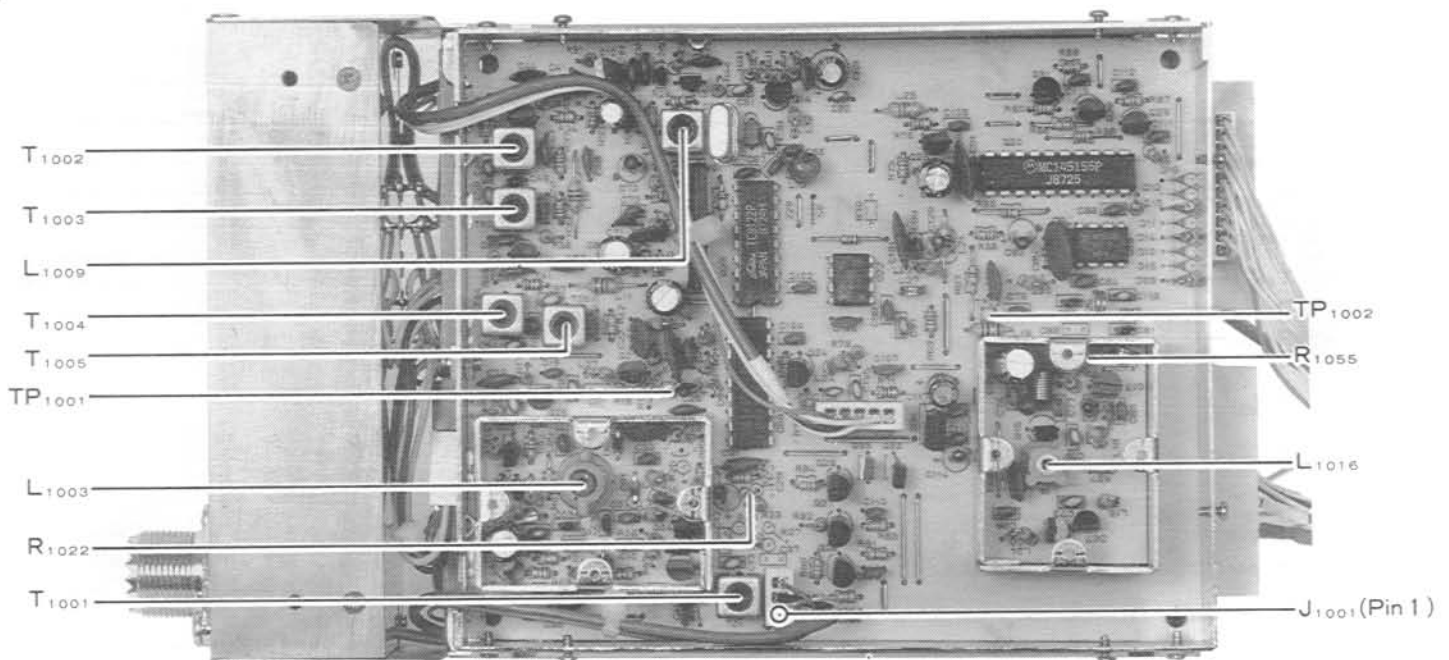

220MHz PLL UNIT ALIGNMENT POINTS

ALIGNMENT (FEX-736-220)

H. 220 MHz Receiver Overall Check

1. Connect the test equipment as shown below.

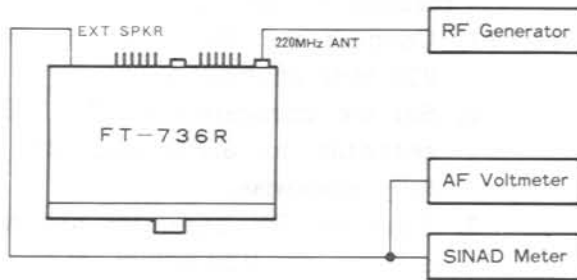

2. Select the FM mode, set the METER selector to S/PO, SQL fully counterclockwise, AF gain to 10 o'clock and RF gain fully clockwise.
3. Tune the transceiver and RF generator to 222.50000 MHz and set the injection level for S-9 indication with ± 3.5 kHz deviation of a 1 kHz tone.
4. Tune the transceiver and RF generator to the high and low band edges and confirm that the injection level required for S-9 indication is within ± 3 dB of that at band center.
5. Retune the transceiver and RF generator to 222.50000 MHz, and confirm that 12dB SINAD is better than -9dB.

6. Select the USB mode and set the injection level to -10dB with no modulation. Confirm at least 12dB (S+N)/N.
7. Remove the test equipment.

I. 220 MHz TX RF (on 220 MHz RF Unit - requires tracking generator and spectrum analyzer)

1. Connect the tracking generator to J2007 and couple the spectrum analyzer to the 220 MHz antenna jack.
2. Set the tracking generator output to -30dBm and adjust CV2002 for the passband shown (reducing injection level, if necessary, to avoid saturation).
3. Remove the test equipment.

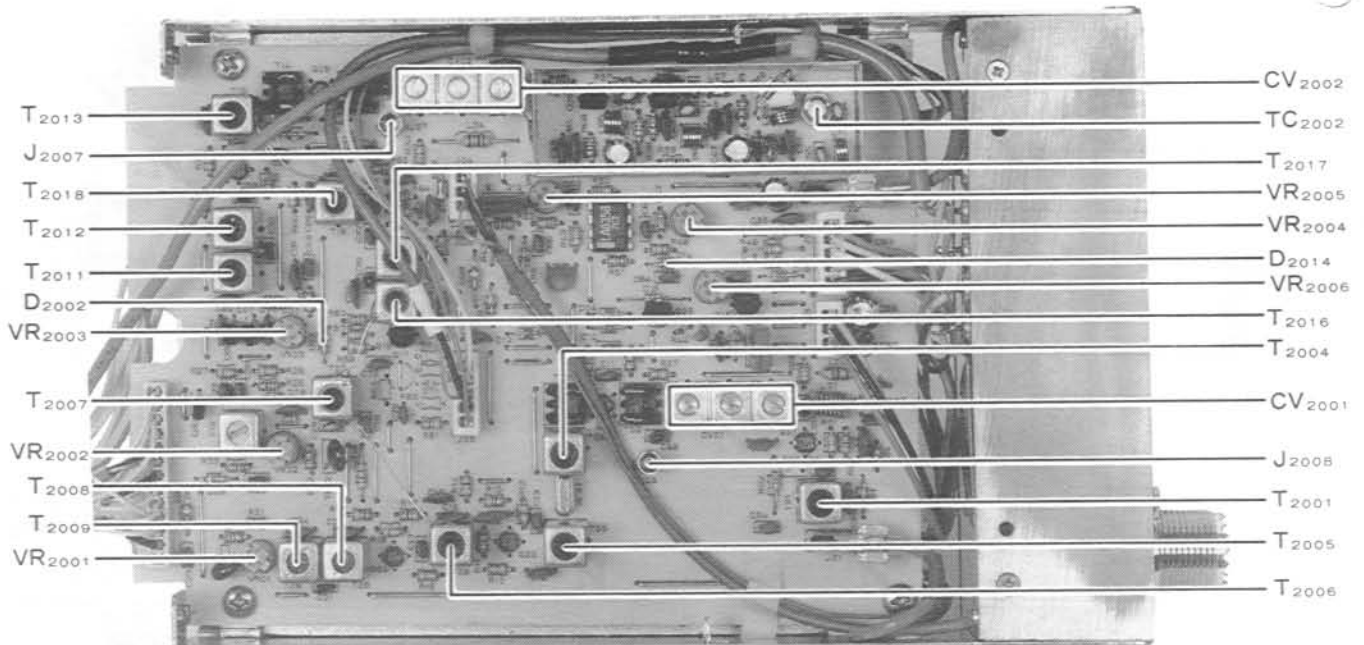
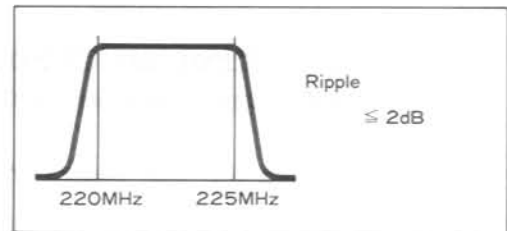

220MHz RF UNIT ALIGNMENT POINTS

(FEX-736-220) ALIGNMENT

J. 220 MHz TX IF, Part I (on 220 MHz RF Unit - requires dummy load and wattmeter)

1. With the dummy load and wattmeter connected to the 220 MHz antenna jack, tune the transceiver to 222.50000 MHz, FM mode.
2. Press the MOX button and set the DRIVE control for 4W output.
3. Adjust T2011-T2013 and TC2002 for maximum deflection on the wattmeter (but do not exceed 5W output: reduce the DRIVE control setting, if necessary).
4. Press the MOX button again to return to receive.

K. 220 MHz AFP (Automatic Final Protection, on 220 MHz RF Unit -requires dummy load and DC voltmeter)

1. With the dummy load connected to the 220 MHz antenna jack, connect the DC voltmeter to the anode of D2014.
2. Set the transceiver to FM, 222.50000 MHz and set the DRIVE control fully clockwise
3. Press the MOX button and adjust VR2004 for 1.0V on the DC voltmeter.
4. Press the MOX button again to return to receive, and remove the voltmeter.

L. 220 MHz ALC level & PO Meter Sensitivity (on 220 MHz RF Unit - requires dummy load and wattmeter)

1. Set the transceiver to 222.50000 MHz, FM mode, and set the METER selector to the S/PO position.
2. With the dummy load and wattmeter connected to the 220 MHz antenna jack, set the DRIVE control fully clockwise.
3. Press the MOX button and alternately adjust VR2005 for 25W on the wattmeter and VR2006 for an indication of "8" on the PO meter scale, repeating both adjustments several times.
4. Press the MOX button to return to receive.

M. 220 MHz TX Mixer (on 220 RF Unit)

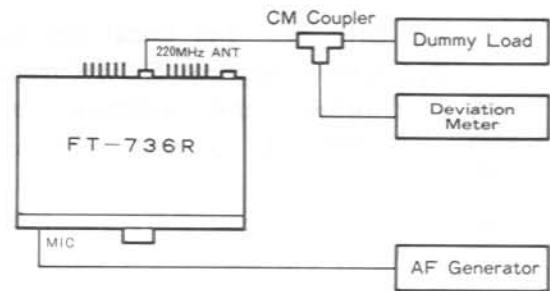

1. Connect the test equipment as shown in the diagram above.
2. In FM mode, tune the transceiver to 222.50000 MHz. Set the MIC gain fully counterclockwise and DRIVE fully clockwise.
3. Press the MOX button and adjust VR2003 so that the spuri at 13.79 MHz on either side of the carrier are at least 65dB down.
4. Press the MOX button again to return to receive.
5. Disconnect the test equipment.

N. 220 MHz TX IF, Part II (on 220 MHz RF Unit)

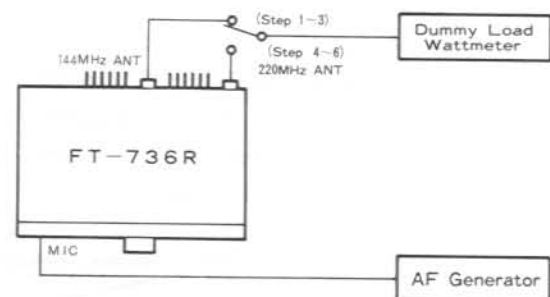

1. Connect the test equipment as shown above, with the AF generator set for 3mV @ 1 kHz.
2. Set the transceiver to USB, at the center of the 144 MHz band.
3. Set the DRIVE control fully clockwise, press the MOX button to transmit, and adjust the MIC gain for 5W output. Press the MOX button again to return to receive.
4. Retune the transceiver to 222.50000 MHz.
5. Press the MOX button and adjust VR2002 for 5W output.
6. Press the MOX button to return to receive, and disconnect the test equipment.

ALIGNMENT (FEX-736-1.2)

VI. FEX-736-1.2

A. 1.2 GHz PLL 2nd Local (on 1.2 GHz PLL Unit - requires DC voltmeter)

1. Connect the voltmeter between R1096 ("A" in the diagram below) and chassis ground.
2. Tune the transceiver to 1280.00000 MHz, FM mode, and adjust TC1001 for 4.0V on the voltmeter.
3. Remove the voltmeter.

B. 1.2 GHz PLL Sub Loop (on 1.2 GHz PLL Unit - requires DC voltmeter)

1. Connect the DC voltmeter between R1025 ("B" in the diagram below) and chassis ground.
2. Tune the transceiver to 1280.01999 MHz, USB mode, and adjust L1008 for 7.5V on the voltmeter.
3. Retune the transceiver to 1280.02000 MHz and confirm at least 1.0V on the voltmeter.
4. Disconnect the voltmeter.

C. 1.2 GHz PLL VCXO (on 1.2 GHz PLL Unit - requires AF and DC voltmeters)

1. Connect the AF millivoltmeter between L1012 ("C" in the diagram below) and chassis ground.
2. Connect the DC voltmeter between TP1001 and chassis ground.

3. Tune the transceiver to 1280.00000 MHz, USB mode, and adjust T1001-T1006 for peak on the AF millivoltmeter.

4. Retune the transceiver to 1280.01999 MHz and adjust L1013 for 4.5V on the DC voltmeter.

5. Retune the transceiver to 1280.02000 MHz and confirm at least 1.0V on the DC voltmeter.

6. Disconnect the voltmeters.

D. 1.2 GHz PLL Main Loop (on 1.2 GHz PLL Unit - requires DC and RF voltmeters)

1. Connect the DC voltmeter between R1083 ("D" in the diagram below) and chassis ground. Connect the RF voltmeter to pin 1 of Q1031.

2. Tune the transceiver to the high band edge, USB mode, and adjust CV1001 and CV1002 for peak on the RF voltmeter. Confirm about 6.0V on the DC voltmeter.

3. Retune the transceiver to the low band edge and confirm at least 1.5V on the DC voltmeter.

4. Disconnect the voltmeters.

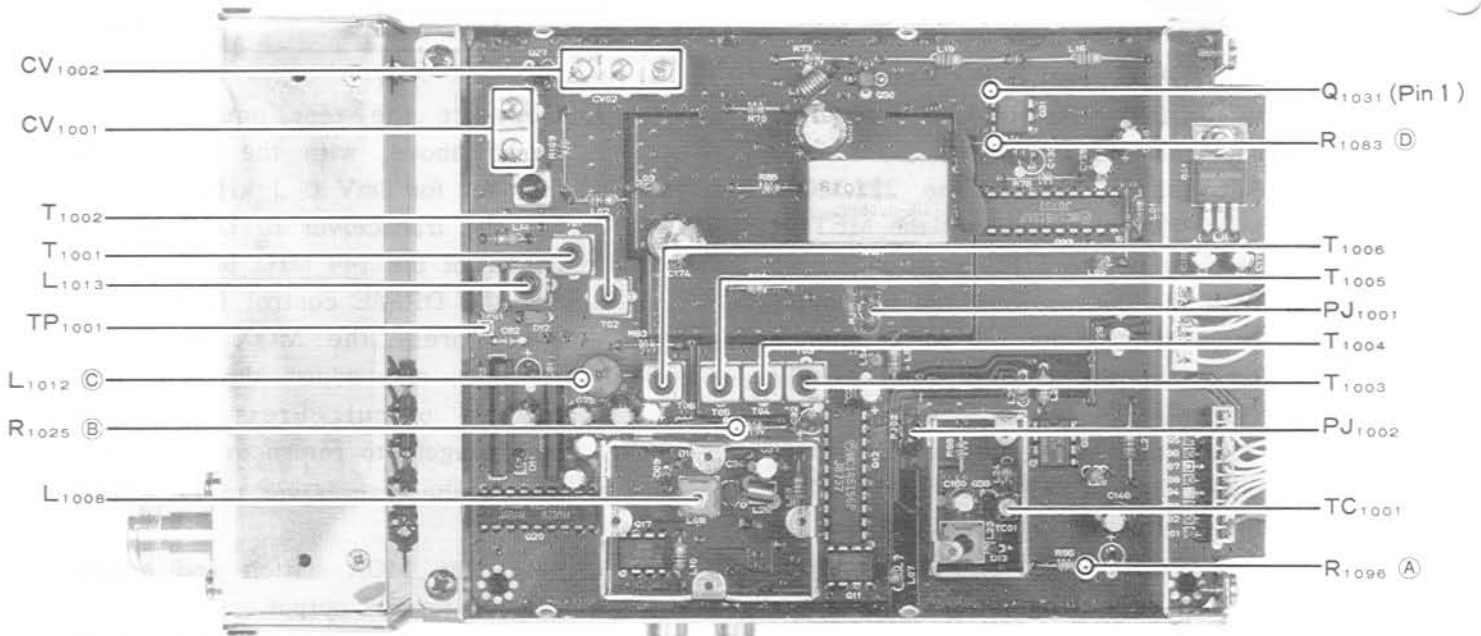

1.2GHz PLL UNIT ALIGNMENT POINTS

E. 1.2 GHz PLL Overall Check (on 1.2 GHz PLL Unit - requires 50-ohm, 1/4-watt resistor and RF voltmeter)

1. Disconnect the TMP plug from PJ1002 and connect the 50-ohm resistor and RF voltmeter in its place.
2. Tune the transceiver to 1280.00000 MHz, FM mode, and confirm about -15dBm on the voltmeter.
3. Move the resistor and meter from PJ1002 to PJ1001 and confirm about +5dBm on the RF voltmeter.
4. Remove the resistor and meter, and replace the TMP plugs.

F. 1.2 GHz RX RF (on 1.2 GHz RF Unit - requires tracking generator and spectrum analyzer)

1. Connect the tracking generator to PJ2002 and the analyzer to PJ2003. Set the tracking generator level to about -30dBm, reducing the level during adjustment, if necessary, to avoid saturation.
2. Adjust CV2001 for the passband shown below.
3. Remove the test equipment.

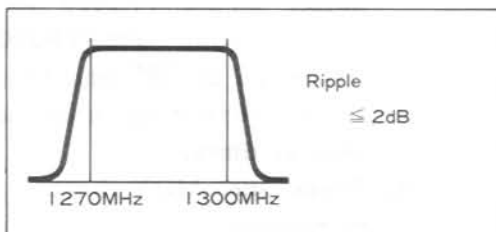

G. 1.2 GHz RX IF (on 1.2 GHz RF Unit - requires RF generator)

1. Connect the RF generator to the 1.2 GHz antenna jack.
2. Set the transceiver to FM, METER selector to S/PO and RF gain fully clockwise.
3. Tune the RF generator and transceiver to 1280.00000 MHz, and inject ± 7 kHz deviation of a 1 kHz tone at a level sufficient to produce S-7 deflection on the S-meter.
4. Adjust T2001-T2010 for peak S-meter deflection.

H. 1.2 GHz Module Gain (on 1.2 GHz RF Unit - requires RF generator)

1. Connect the RF generator to the 1.2 GHz antenna jack.
2. Set the transceiver to USB, METER selector to S/PO and RF gain fully clockwise.
3. Tune to 1280.00000 MHz.
4. Inject a 20dBu carrier with no modulation 1.5 kHz above the transceiver frequency, and adjust VR2004 for S-9 S-meter deflection.
5. Tune the transceiver and RF generator as indicated below, and confirm that the injection level required for S-9 indication is within ± 3 dB of that required at 1280.00000 MHz.

Transceiver	RF Generator
1299.99999 MHz	1300.00149 MHz
1260.00000 MHz	1260.00150 MHz

6. Connect the jumper plug at J2001 and retune the transceiver to 1280.00000 MHz.
7. Inject a 40dB carrier with no modulation 1.5 kHz above the transceiver frequency, and adjust TC2001 for S-9 S-meter deflection.

I. 1.2 GHz Receiver Overall Check

1. Connect the test equipment as shown below.

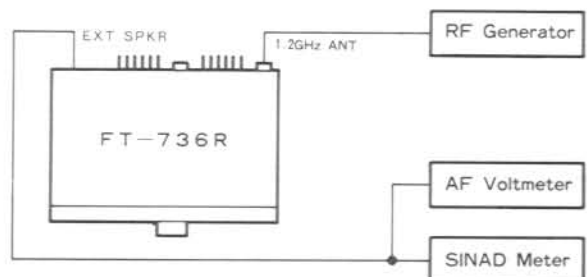

2. Select the FM mode, set the METER selector to S/PO, SQL fully counterclockwise, AF gain to 10 o'clock and RF gain fully clockwise.
3. Tune the transceiver and RF generator to 1280.00000 MHz. Inject a 1 kHz tone with ± 3.5 kHz deviation, and confirm a 12dB SINAD better than -9dB.

ALIGNMENT (FEX-736-1.2)

4. Select the USB mode and set the injection level to -10dB with no modulation. Confirm at least 12dB $(S+N)/N$.
 5. Remove the test equipment.
- J. 1.2 GHz TX RF (on 1.2 GHz RF Unit - requires tracking generator and spectrum analyzer)
1. Connect the tracking generator to PJ2004 and the spectrum analyzer to PJ2001.
 2. Set the tracking generator output to -30dBm and adjust CV2003 and CV2004 for the passband shown below (reducing injection level, if necessary, to avoid saturation).
 3. Remove the test equipment.

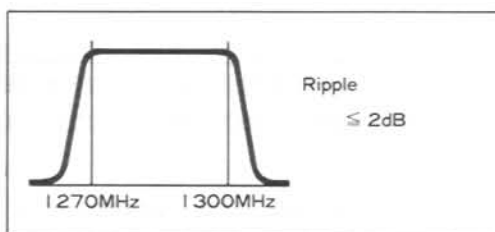

- K. 1.2 GHz TX IF, Part I (on 1.2 GHz RF Unit - requires dummy load and wattmeter)
1. With the dummy load and wattmeter connected to the 1.2 GHz antenna jack, tune the transceiver to 1280.00000 MHz , FM mode.
 2. Press the MOX button and set the DRIVE control for 4W output.
 3. Adjust T2011 and T2013-T2016 for maximum deflection on the wattmeter (but do not exceed 5W output: reduce the DRIVE control setting, if necessary).
 4. Press the MOX button again to return to receive.
- L. 1.2 GHz ALC level & PO Meter Sensitivity (on 1.2 GHz RF Unit - requires dummy load and wattmeter)
1. Set the transceiver to 1280.00000 MHz , FM mode, and set the METER selector to the S/PO position.
 2. With the dummy load and wattmeter connected to the 1.2 GHz antenna jack, set the DRIVE control fully clockwise.
 3. Press the MOX button and alternately adjust VR2002 for 10W on the wattmeter and VR2003 for an indication of "8" on the PO meter scale, repeating both adjustments several times.
 4. Press the MOX button to return to receive.

(FEX-736-1.2) ALIGNMENT

M. 1.2 GHz TX Mixer (on 1.2 GHz RF Unit)

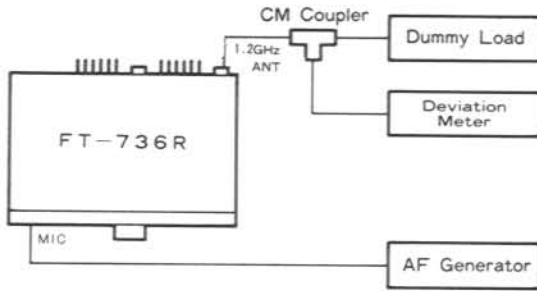

1. Connect the test equipment as shown in the diagram above.
2. In FM mode, tune the transceiver to 1280.00000 MHz. Set the MIC gain fully counterclockwise and DRIVE fully clockwise.
3. Press the MOX button and adjust VR2006 so that the spurs at 13.79 MHz on either side of the carrier are at least 65dB down.
4. Press the MOX button again to return to receive.
5. Disconnect the test equipment.

N. 1.2 GHz TX IF, Part II (on 1.2 GHz RF Unit)

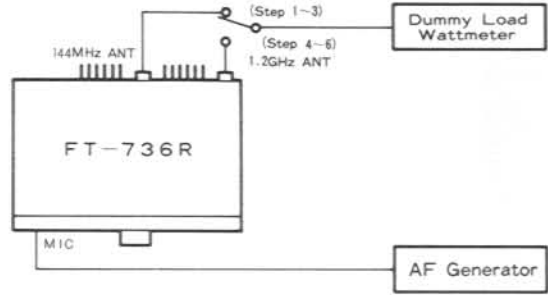

1. Connect the test equipment as shown above, with the AF generator set for 3mV @ 1 kHz.
2. Set the transceiver to USB, at the center of the 144 MHz band.
3. Set the DRIVE control fully clockwise, press the MOX button to transmit, and adjust the MIC gain for 5W output. Press the MOX button again to return to receive.
4. Retune the transceiver to 1280.00000 MHz, FM mode.
5. Press the MOX button and adjust VR2005 for 5W output.
6. Press the MOX button to return to receive, and disconnect the test equipment.

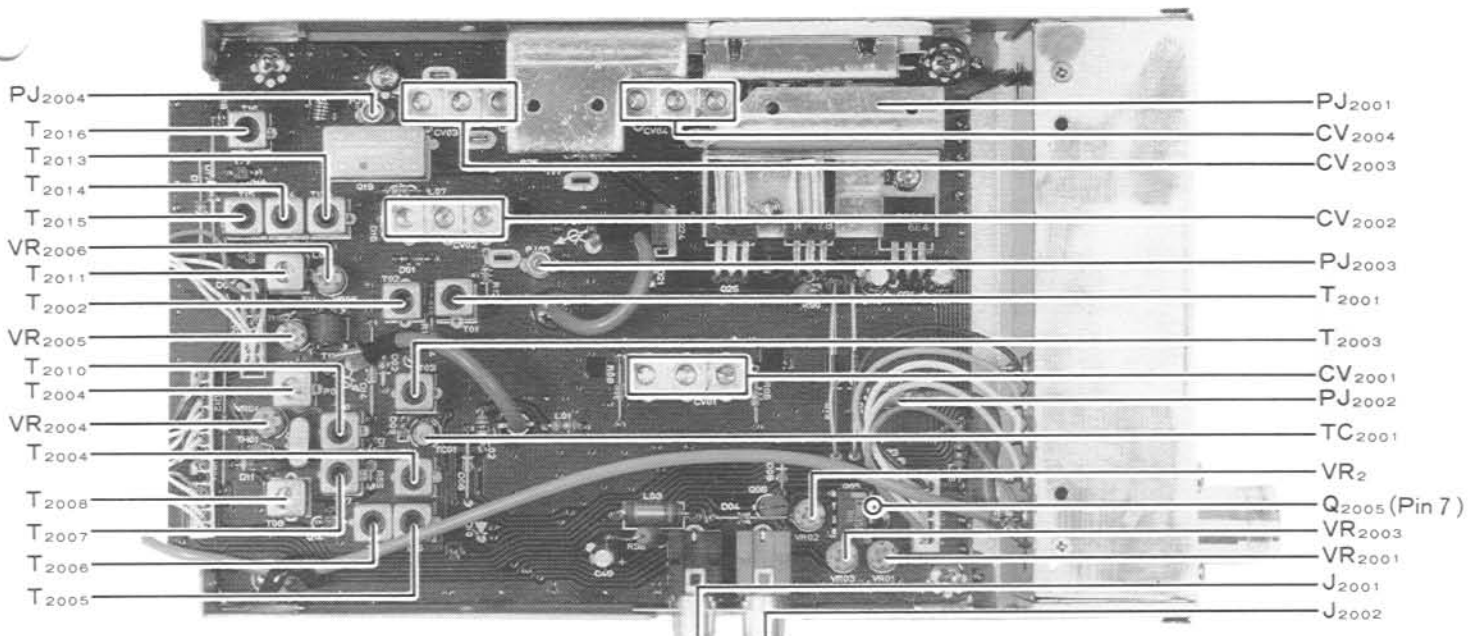

1.2GHz RF UNIT ALIGNMENT POINTS

PARTS LIST

MAIN CHASSIS			
Symbol No.	Part No.	Description	Device
Q1	G1090294	IC	uPC7808H
Q2	G1090778	IC	L7809
Q3	G1090778	IC	L7809
Q4	G3334200G	Transistor	2SC3420GR
R1(10W)	J01225682	Carbon Film RES.	1/6W 6.8k ohm PJ
C6	K21170002	Feed Through CAP.	50WV 0.001uF
C7	K21170002	Feed Through CAP.	50WV 0.001uF
C8	K21170002	Feed Through CAP.	50WV 0.001uF
C9	K21170002	Feed Through CAP.	50WV 0.001uF
C10	K21170002	Feed Through CAP.	50WV 0.001uF
C11	K21170002	Feed Through CAP.	50WV 0.001uF
C12	K21170002	Feed Through CAP.	50WV 0.001uF
C13	K21170002	Feed Through CAP.	50WV 0.001uF
C14	K21170002	Feed Through CAP.	50WV 0.001uF
C15	K21170002	Feed Through CAP.	50WV 0.001uF
	L2190002	Coil	
	L9190035	Ferrite Beads	
M1	M0290055	Meter	
SP1	M4090047	Speaker	
S1	N4090020	Push Switch	
J2	T9205548A	Connector (13.8V DC)	
J3	P0090608	Connector (AC)	
J4	P1090352	Connector (144MHz ANT)	
J5(M Type)	P1090352	Connector (430MHz ANT)	
J5(N Type)	P1090547	Connector (430MHz ANT)	
F1 (100,117V)	Q0000006	Fuse	4A
F1 (220,234V)	Q0000003	Fuse	2A
FH1	P2000012	Fuse Holder	
PL1	Q1000047	Lamp	
PL2	Q1000047	Lamp	
	Q9000358A	Rotary Encoder	MAIN DIAL
	T9205498	Wire ASSY	P1-P48,P49
	T9205499C	Wire ASSY	P2-P33,P34,P41
	T9205500A	Wire ASSY	P3-P53,P54
	T9205501C	Wire ASSY	P5-P82
	T9205502B	Wire ASSY	P6-P96
	T9205503	Wire ASSY	P11-P125
	T9205504	Wire ASSY	P12-P27
	T9205505	Wire ASSY	P13-P23,P26
	T9205506	Wire ASSY	P14-P28
	T9205507A	Wire ASSY	P15-P29
	T9205508	Wire ASSY	P16-P101
	T9205509	Wire ASSY	P17
	T9205510	Wire ASSY	P19-P108,P110
	T9205511A	Wire ASSY	P20-P126
	T9205512	Wire ASSY	P21-P106
	T9205513B	Wire ASSY	MIC JACK
	T9205514	Wire ASSY	P25-P59
	T9205515A	Wire ASSY	P30-P64
	T9205516A	Wire ASSY	P31-P18
	T9205517	Wire ASSY	P32-P105
	T9205518	Wire ASSY	P35-P116
	T9205519	Wire ASSY	P36-P127
	T9205520	Wire ASSY	P37-P124
	T9205521	Wire ASSY	P38-P113,P115,P116
	T9205522	Wire ASSY	P39-P52
	T9205523	Wire ASSY	P40-P70
	T9205524A	Wire ASSY	P42-P4
	T9205525	Wire ASSY	P43-P50
	T9205526B	Wire ASSY	P44-P71,P119
	T9205527A	Wire ASSY	P45
	T9205528	Wire ASSY	P56-P63
	T9205529A	Wire ASSY	P57-P46
	T9205530	Wire ASSY	P58-P114
	T9205531A	Wire ASSY	P60-P112,P121
	T9205532	Wire ASSY	P61-P100
	T9205533A	Wire ASSY	P65-P118
	T9205534	Wire ASSY	P68-P75,P76,P79
	T9205535	Wire ASSY	P69-P23,P24,P83,P93,P94
	T9205536B	Wire ASSY	P72-P73
	T9205537	Wire ASSY	P77
	T9205538B	Wire ASSY	P92-P84-P97-P91
	T9205540	Wire ASSY	P86-P99
	T9205542A	Wire ASSY	P103-P120
	T9205543A	Wire ASSY	P123-P128
	T9205609	Wire ASSY	P88
	T9205547E	Wire ASSY	
	T9205553	Wire ASSY	P109
	T9316102	Wire ASSY	P95-P87
	R0804550B	Chassis	
	R0509930	Panel Rear	
	R5804580A	Heat Sink	
	R0509940	Shield Case PA.	
	R0804620B	Front Panel	
	R1804590	Case Top	
	R1804600	Case Bottom	
	R7082630	SP Net	
	R0083600	Mount Spring	
	R3084745	Handle	
	R0115070	Handle Shaft	
	R4115020	Handle End	
	R3054370	Foot	30
	S4000025	Foot	FF-008
	R6025944B	Support D	
	R6119640	Nut	
	S6000032	Nylon Rivet	3.0x5.5
	S6000031	Nylon Rivet	3.0x4.5
	R1122150	Cover	
	R0123770	Ground Lead	
	S5000057	Lead Clamper	L=38
	R6124610	Support	
	R0804610	Panel	
	R7121180	Window	
	R8116670	Plate	
	R3116100A	Knob	MAIN DIAL
	R3078110C	Ring	MAIN DIAL
	R3121200	Knob	PRI,0
	R3121201	Knob	VFO,1
	R3121202	Knob	MR,2
	R3121203	Knob	PMS,3
	R3121204	Knob	V*M,4
	R3121205	Knob	REV,5
	R3121206	Knob	STEP,6
	R3121207	Knob	MCK,7
	R3121208	Knob	TSET,8
	R3121209	Knob	V*M,9
	R3121210	Knob	CLAR, CODE
	R3121211	Knob	BAND, SHIFT
	R3121212	Knob	CALL1,*
	R3121213	Knob	CALL2,#
	R3121214	Knob	SPEAK
	R3115320	Knob	UP
	R3115330	Knob	DOWN
	R3115340	Knob	CH UP
	R3115350	Knob	CH DOWN
	R3116820	Knob	MODE, RESET, CAC,
			AQS, DSQL
	R3115310	Knob	POWER
	R3115390A	Knob	MOX
	R3115400B	Knob	PROC, KEYER, BURST,
			PAUSE, DIM, VFO, F,
			ENT, T CALL PREAMP
			D LOCK, FMCH, SSBCH,
			NB, NOTCH
	R3111182	Knob	VOX, KEYER SPEED,
			AGC
	R3101020B	Knob	FT-14VK(METER, SAT)
	R3085851	Knob	FT-18XK(MONITOR)
	R3510180	Knob	CHANNEL
	R3100770B	Knob	FT-13WK
			(MIC, SQL, AF, SHIFT)

PARTS LIST

R3013	J02225104	Carbon Film RES.	1/6W 100k ohm	UJ	R3061	J01225103	Carbon Film RES.	1/6W 10k ohm	PJ
R3014	J01225104	Carbon Film RES.	1/6W 100k ohm	PJ	R3062	J01225223	Carbon Film RES.	1/6W 22k ohm	PJ
R3015	J02225104	Carbon Film RES.	1/6W 100k ohm	UJ	R3063	J01225102	Carbon Film RES.	1/6W 1k ohm	PJ
R3016	J01225223	Carbon Film RES.	1/6W 22k ohm	PJ	R3064	J01225223	Carbon Film RES.	1/6W 22k ohm	PJ
R3017	J02225223	Carbon Film RES.	1/6W 22k ohm	UJ	R3065	J01225102	Carbon Film RES.	1/6W 1k ohm	PJ
R3018	J02225560	Carbon Film RES.	1/6W 56 ohm	UJ	R3066	J01225223	Carbon Film RES.	1/6W 22k ohm	PJ
R3019	J02225222	Carbon Film RES.	1/6W 2.2k ohm	UJ	R3067	J01225472	Carbon Film RES.	1/6W 4.7k ohm	PJ
R3020	J01225562	Carbon Film RES.	1/6W 5.6k ohm	PJ	R3068	J02225472	Carbon Film RES.	1/6W 4.7k ohm	UJ
R3021	J02225223	Carbon Film RES.	1/6W 22k ohm	UJ	R3069	J01225682	Carbon Film RES.	1/6W 6.8k ohm	PJ
R3022	J02225221	Carbon Film RES.	1/6W 220 ohm	UJ	R3070	J01225682	Carbon Film RES.	1/6W 6.8k ohm	PJ
R3023	J01225560	Carbon Film RES.	1/6W 56 ohm	PJ	R3071	J02225332	Carbon Film RES.	1/6W 3.3k ohm	UJ
R3024	J01225222	Carbon Film RES.	1/6W 2.2k ohm	PJ	R3072	J01225682	Carbon Film RES.	1/6W 6.8k ohm	PJ
R3025	J02225560	Carbon Film RES.	1/6W 56 ohm	UJ	R3073	J01225223	Carbon Film RES.	1/6W 22k ohm	PJ
R3026	J01225472	Carbon Film RES.	1/6W 4.7k ohm	PJ	R3074	J02225103	Carbon Film RES.	1/6W 10k ohm	UJ
R3028	J02225472	Carbon Film RES.	1/6W 4.7k ohm	UJ	R3075	J02225470	Carbon Film RES.	1/6W 47 ohm	UJ
R3029	J01225682	Carbon Film RES.	1/6W 6.8k ohm	PJ	R3076	J01225473	Carbon Film RES.	1/6W 47k ohm	PJ
R3030	J02225332	Carbon Film RES.	1/6W 3.3k ohm	UJ	R3077	J02225101	Carbon Film RES.	1/6W 100 ohm	UJ
R3031	J02225472	Carbon Film RES.	1/6W 4.7k ohm	UJ	R3078	J02225224	Carbon Film RES.	1/6W 220k ohm	UJ
R3032	J02225473	Carbon Film RES.	1/6W 47k ohm	UJ	R3079	J01225101	Carbon Film RES.	1/6W 100 ohm	PJ
R3033	J02225473	Carbon Film RES.	1/6W 47k ohm	UJ	R3080	J02225102	Carbon Film RES.	1/6W 1k ohm	UJ
R3034	J01225471	Carbon Film RES.	1/6W 470 ohm	PJ	R3082	J01225102	Carbon Film RES.	1/6W 1k ohm	PJ
R3035	J01225560	Carbon Film RES.	1/6W 56 ohm	PJ	R3084	J02225333	Carbon Film RES.	1/6W 33k ohm	UJ
R3036	J02225222	Carbon Film RES.	1/6W 2.2k ohm	UJ	R3085	J01225560	Carbon Film RES.	1/6W 56 ohm	PJ
R3037	J02225224	Carbon Film RES.	1/6W 220k ohm	PJ	R3086	J02225103	Carbon Film RES.	1/6W 10k ohm	UJ
R3038	J02225222	Carbon Film RES.	1/6W 2.2k ohm	UJ	R3087	J02225123	Carbon Film RES.	1/6W 12k ohm	UJ
R3039	J02225102	Carbon Film RES.	1/6W 1k ohm	UJ	R3088	J02225103	Carbon Film RES.	1/6W 10k ohm	UJ
R3040	J02225153	Carbon Film RES.	1/6W 15k ohm	UJ	R3089	J01225103	Carbon Film RES.	1/6W 10k ohm	PJ
R3041	J02225153	Carbon Film RES.	1/6W 15k ohm	UJ	R3091	J02225332	Carbon Film RES.	1/6W 3.3k ohm	UJ
R3042	J01225101	Carbon Film RES.	1/6W 100 ohm	PJ	R3092	J01225104	Carbon Film RES.	1/6W 100k ohm	PJ
R3043	J02225103	Carbon Film RES.	1/6W 10k ohm	UJ	R3093	J01225102	Carbon Film RES.	1/6W 1k ohm	PJ
R3044	J01225102	Carbon Film RES.	1/6W 1k ohm	PJ	R3094	J01225224	Carbon Film RES.	1/6W 220k ohm	PJ
R3045	J02225103	Carbon Film RES.	1/6W 10k ohm	UJ	R3095	J02225104	Carbon Film RES.	1/6W 100k ohm	UJ
R3046	J02225101	Carbon Film RES.	1/6W 100 ohm	UJ	R3096	J02225101	Carbon Film RES.	1/6W 100 ohm	UJ
R3051	J02225334	Carbon Film RES.	1/6W 330k ohm	UJ	R3097	J02225102	Carbon Film RES.	1/6W 1k ohm	UJ
R3052	J01225104	Carbon Film RES.	1/6W 100k ohm	PJ	R3099	J02225103	Carbon Film RES.	1/6W 10k ohm	UJ
R3053	J01225472	Carbon Film RES.	1/6W 4.7k ohm	PJ	R3100	J02225104	Carbon Film RES.	1/6W 100k ohm	UJ
R3054	J02225224	Carbon Film RES.	1/6W 220k ohm	UJ	R3101	J02225332	Carbon Film RES.	1/6W 3.3k ohm	UJ
R3055	J01225103	Carbon Film RES.	1/6W 10k ohm	PJ	R3102	J02225104	Carbon Film RES.	1/6W 100k ohm	UJ
R3056	J02225101	Carbon Film RES.	1/6W 100 ohm	UJ	R3103	J01225332	Carbon Film RES.	1/6W 3.3k ohm	PJ
R3057	J02225224	Carbon Film RES.	1/6W 220k ohm	UJ	R3105	J02225101	Carbon Film RES.	1/6W 100 ohm	UJ
R3058	J01225562	Carbon Film RES.	1/6W 5.6k ohm	PJ	R3108	J02225222	Carbon Film RES.	1/6W 2.2k ohm	UJ
R3059	J01225102	Carbon Film RES.	1/6W 1k ohm	PJ	R3109	J01225221	Carbon Film RES.	1/6W 220 ohm	PJ
R3060	J01225223	Carbon Film RES.	1/6W 22k ohm	PJ	R3110	J02225472	Carbon Film RES.	1/6W 4.7k ohm	UJ

PARTS LIST

R3111	J02225102	Carbon Film RES.	1/6W 1k ohm	UJ	R3157	J02225223	Carbon Film RES.	1/6W 22k ohm	UJ
R3112	J02225334	Carbon Film RES.	1/6W 330k ohm	UJ	R3159	J01225333	Carbon Film RES.	1/6W 33k ohm	PJ
R3113	J02225104	Carbon Film RES.	1/6W 100k ohm	UJ	R3160	J01225222	Carbon Film RES.	1/6W 2.2k ohm	PJ
R3114	J02225473	Carbon Film RES.	1/6W 47k ohm	UJ	R3161	J01225221	Carbon Film RES.	1/6W 220 ohm	PJ
R3115	J02225222	Carbon Film RES.	1/6W 2.2k ohm	UJ	R3162	J02225331	Carbon Film RES.	1/6W 330 ohm	UJ
R3116	J01225223	Carbon Film RES.	1/6W 22k ohm	PJ	R3163	J01225223	Carbon Film RES.	1/6W 22k ohm	PJ
R3117	J02225334	Carbon Film RES.	1/6W 330k ohm	UJ	R3164	J01225223	Carbon Film RES.	1/6W 22k ohm	PJ
R3118	J01225152	Carbon Film RES.	1/6W 1.5k ohm	PJ	R3168	J02225104	Carbon Film RES.	1/6W 100k ohm	UJ
R3119	J02225560	Carbon Film RES.	1/6W 56 ohm	UJ	R3169	J02225473	Carbon Film RES.	1/6W 47k ohm	UJ
R3120	J02225474	Carbon Film RES.	1/6W 470k ohm	UJ	R3170	J01225101	Carbon Film RES.	1/6W 100 ohm	PJ
R3121	J02225152	Carbon Film RES.	1/6W 1.5k ohm	UJ	R3172	J01225153	Carbon Film RES.	1/6W 15k ohm	PJ
R3122	J02225222	Carbon Film RES.	1/6W 2.2k ohm	UJ	R3173	J01225102	Carbon Film RES.	1/6W 1k ohm	PJ
R3123	J02225474	Carbon Film RES.	1/6W 470k ohm	UJ	R3174	J24205561	RES. Chip	1/10W 560 ohm	
R3124	J02225104	Carbon Film RES.	1/6W 100k ohm	UJ	R3175	J24205223	RES. Chip	1/10W 22k ohm	
R3125	J01225103	Carbon Film RES.	1/6W 10k ohm	PJ	R3176	J02225472	Carbon Film RES.	1/6W 4.7k ohm	UJ
R3126	J02225472	Carbon Film RES.	1/6W 4.7k ohm	UJ	R3177	J01225222	Carbon Film RES.	1/6W 2.2k ohm	PJ
R3127	J02225104	Carbon Film RES.	1/6W 100k ohm	UJ	VR3001	J51745472	POT.	B 4.7k ohm	
R3128	J02225473	Carbon Film RES.	1/6W 47k ohm	UJ	VR3002	J51745104	POT.	B 100k ohm	
R3129	J02225334	Carbon Film RES.	1/6W 330k ohm	UJ	VR3003	J51745103	POT.	B 10k ohm	
R3131	J01225272	Carbon Film RES.	1/6W 2.7k ohm	PJ	VR3004	J51745103	POT.	B 10k ohm	
R3132	J01225223	Carbon Film RES.	1/6W 22k ohm	PJ	VR3005	J51745103	POT.	B 10k ohm	
R3133	J02225334	Carbon Film RES.	1/6W 330k ohm	UJ	VR3006	J51745473	POT.	B 47k ohm	
R3134	J02225152	Carbon Film RES.	1/6W 1.5k ohm	UJ	VR3007	J51745103	POT.	B 10k ohm	
R3135	J01225560	Carbon Film RES.	1/6W 56 ohm	PJ	VR3008	J51745102	POT.	B 1k ohm	
R3136	J02225224	Carbon Film RES.	1/6W 220k ohm	UJ	VR3009	J51745223	POT.	B 22k ohm	
R3137	J02225222	Carbon Film RES.	1/6W 2.2k ohm	UJ	VR3010	J51745104	POT.	B 100k ohm	
R3138	J02225101	Carbon Film RES.	1/6W 100 ohm	UJ	VR3011	J51745103	POT.	B 10k ohm	
R3139	J02225103	Carbon Film RES.	1/6W 10k ohm	UJ	VR3012	J51745102	POT.	B 1k ohm	
R3140	J02225335	Carbon Film RES.	1/6W 3.3M ohm	UJ	C3001	K13179008	Ceramic CAP.	F 50WV 0.01uF	
R3141	J02225472	Carbon Film RES.	1/6W 4.7k ohm	UJ	C3002	K40109001	AL. Electro. CAP.	10WV 100uF	
R3142	J02225102	Carbon Film RES.	1/6W 1k ohm	UJ	C3003	K05175151	Ceramic CAP.	RH 50WV 150pF	
R3143	J01225153	Carbon Film RES.	1/6W 15k ohm	PJ	C3004	K05175151	Ceramic CAP.	RH 50WV 150pF	
R3144	J02225222	Carbon Film RES.	1/6W 2.2k ohm	UJ	C3005	K05175220	Ceramic CAP.	RH 50WV 22pF	
R3145	J02225560	Carbon Film RES.	1/6W 56 ohm	UJ	C3006	K05173100	Ceramic CAP.	RH 50WV 10pF	
R3146	J02225223	Carbon Film RES.	1/6W 22k ohm	UJ	C3007	K13179008	Ceramic CAP.	F 50WV 0.01uF	
R3147	J01225223	Carbon Film RES.	1/6W 22k ohm	PJ	C3008	K00175150	Ceramic CAP.	SL 50WV 15pF	
R3148	J01225223	Carbon Film RES.	1/6W 22k ohm	PJ	C3009	K13179008	Ceramic CAP.	F 50WV 0.01uF	
R3149	J01225560	Carbon Film RES.	1/6W 56 ohm	PJ	C3010	K00175180	Ceramic CAP.	SL 50WV 18pF	
R3151	J02225471	Carbon Film RES.	1/6W 470 ohm	UJ	C3011	K13179010	Ceramic CAP.	F 50WV 0.022uF	
R3152	J02225473	Carbon Film RES.	1/6W 47k ohm	UJ	C3012	K13179008	Ceramic CAP.	F 50WV 0.01uF	
R3154	J02225104	Carbon Film RES.	1/6W 100k ohm	UJ	C3013	K13179010	Ceramic CAP.	F 50WV 0.022uF	
R3155	J02225104	Carbon Film RES.	1/6W 100k ohm	UJ	C3014	K12171102	Ceramic CAP.	E 50WV 0.001uF	
R3156	J02225472	Carbon Film RES.	1/6W 4.7k ohm	UJ	C3015	K05173080	Ceramic CAP.	RH 50WV 8p	
					C3016	K13179008	Ceramic CAP.	F 50WV 0.01uF	
					C3018	K12171102	Ceramic CAP.	E 50WV 0.001uF	
					C3019	K05175151	Ceramic CAP.	RH 50WV 150pF	
					C3020	K13179008	Ceramic CAP.	F 50WV 0.01uF	
					C3021	K05172050	Ceramic CAP.	RH 50WV 5pF	
					C3022	K05175151	Ceramic CAP.	RH 50WV 150pF	
					C3023	K13179010	Ceramic CAP.	F 50WV 0.022uF	
					C3024	K13179010	Ceramic CAP.	F 50WV 0.022uF	
					C3025	K00172040	Ceramic CAP.	SL 50WV 4pF	
					C3026	K12171102	Ceramic CAP.	E 50WV 0.001uF	
					C3027	K00173090	Ceramic CAP.	SL 50WV 9pF	
					C3028	K13179010	Ceramic CAP.	F 50WV 0.022uF	
					C3029	K40129004	AL. Electro. CAP.	16WV 10uF	
					C3030	K13179008	Ceramic CAP.	F 50WV 0.01uF	
					C3031	K13179008	Ceramic CAP.	F 50WV 0.01uF	
					C3032	K13179008	Ceramic CAP.	F 50WV 0.01uF	
					C3033	K13179008	Ceramic CAP.	F 50WV 0.01uF	
					C3034	K40129004	AL. Electro. CAP.	16WV 10uF	
					C3035	K00173070	Ceramic CAP.	SL 50WV 7pF	
					C3036	K00173070	Ceramic CAP.	SL 50WV 7pF	
					C3037	K13179008	Ceramic CAP.	F 50WV 0.01uF	
					C3038	K19149021	Ceramic CAP.	25WV 0.047uF	
					C3039	K12171102	Ceramic CAP.	E 50WV 0.001uF	
					C3040	K13179010	Ceramic CAP.	F 50WV 0.022uF	
					C3041	K13179010	Ceramic CAP.	F 50WV 0.022uF	

PARTS LIST

C3042	K13179010	Ceramic CAP.	F	50WV	0.022uF	C3133	K70107106	Tantalum CAP.		10WV	10uF
C3044	K13179010	Ceramic CAP.	F	50WV	0.022uF	C3134	K40109001	AL. Electro. CAP.		10WV	100uF
C3047	K00173100	Ceramic CAP.	SL	50WV	10pF						
C3048	K00175331	Ceramic CAP.	SL	50WV	330pF	C3135	K19149021	Ceramic CAP.		25WV	0.047uF
C3049	K12171102	Ceramic CAP.	F	50WV	0.001uF	C3136	K13179010	Ceramic CAP.	F	50WV	0.022uF
C3050	K12171102	Ceramic CAP.	F	50WV	0.001uF	C3137	K40129004	AL. Electro. CAP.		16WV	10uF
C3051	K13179010	Ceramic CAP.	F	50WV	0.022uF						
C3052	K40179013	AL. Electro. CAP.		50WV	1uF	C3138	K12171102	Ceramic CAP.	E	50WV	0.001uF
						C3139	K40179013	AL. Electro. CAP.		50WV	1uF
C3053	K13179008	Ceramic CAP.	F	50WV	0.01uF	C3140	K13179008	Ceramic CAP.	F	50WV	0.01uF
C3054	K19149025	Ceramic CAP.		25WV	0.1uF	C3141	K13179010	Ceramic CAP.	F	50WV	0.022uF
C3055	K19149025	Ceramic CAP.		25WV	0.1uF	C3142	K12171102	Ceramic CAP.	E	50WV	0.001uF
C3056	K19149025	Ceramic CAP.		25WV	0.1uF	C3144	K40129004	AL. Electro. CAP.		16WV	10uF
C3057	K19149025	Ceramic CAP.		25WV	0.1uF						
C3058	K19149025	Ceramic CAP.		25WV	0.1uF	C3145	K70147105	Tantalum CAP.		25WV	1uF
C3059	K19149025	Ceramic CAP.		25WV	0.1uF	C3147	K12171102	Ceramic CAP.	E	50WV	0.001uF
C3060	K19149025	Ceramic CAP.		25WV	0.1uF	C3150	K70107106	Tantalum CAP.		10WV	10uF
C3061	K19149025	Ceramic CAP.		25WV	0.1uF	C3152	K40179016	AL. Electro. CAP.		50WV	0.1uF
C3062	K19149013	Ceramic CAP.		25WV	0.01uF						
C3063	K19149013	Ceramic CAP.		25WV	0.01uF	C3153	K40129004	AL. Electro. CAP.		16WV	10uF
C3064	K12171102	Ceramic CAP.	E	50WV	0.001uF						
C3065	K13179008	Ceramic CAP.	F	50WV	0.01uF	C3154	K40179013	AL. Electro. CAP.		50WV	1uF
C3066	K19149021	Ceramic CAP.		25WV	0.047uF						
C3067	K12171102	Ceramic CAP.	E	50WV	0.001uF	C3156	K13179008	Ceramic CAP.	F	50WV	0.01uF
C3068	K19149022	Ceramic CAP.		25WV	0.047uF	C3157	K13179008	Ceramic CAP.	F	50WV	0.01uF
C3069	K70107106	Tantalum CAP.		10WV	10uF	C3158	K00175101	Ceramic CAP.	SL	50WV	100pF
C3070	K19149021	Ceramic CAP.		25WV	0.047uF	C3159	K00175331	Ceramic CAP.	SL	50WV	330pF
C3072	K13179008	Ceramic CAP.	F	50WV	0.01uF	C3160	K00175101	Ceramic CAP.	SL	50WV	100pF
C3073	K19149021	Ceramic CAP.		25WV	0.047uF	C3161	K40149001	AL. Electro. CAP.		25WV	4.7uF
074	K19149021	Ceramic CAP.		25WV	0.047uF						
075	K19149021	Ceramic CAP.		25WV	0.047uF	C3162	K70107226	Tantalum CAP.		10WV	22uF
C3076	K19149021	Ceramic CAP.		25WV	0.047uF	C3163	K13179008	Ceramic CAP.	F	50WV	0.01uF
C3077	K19149013	Ceramic CAP.		25WV	0.01uF	C3164	K40179013	AL. Electro. CAP.		50WV	1uF
C3080	K40129004	AL. Electro. CAP.		16WV	10uF						
						C3166	K12171102	Ceramic CAP.	E	50WV	0.001uF
C3081	K13179008	Ceramic CAP.	F	50WV	0.01uF	C3167	K19149009	Ceramic CAP.		25WV	0.0047uF
C3082	K19149013	Ceramic CAP.		25WV	0.01uF	C3168	K19149021	Ceramic CAP.		25WV	0.0047uF
C3083	K12171102	Ceramic CAP.	E	50WV	0.001uF						
C3084	K40179016	AL. Electro. CAP.		50WV	0.1uF						
						T3001	L0021533	Coil			
C3085	K19149025	Ceramic CAP.		25WV	0.1uF	T3002	L0021735	Coil			
C3087	K19149021	Ceramic CAP.		25WV	0.047uF	T3003	L0021735	Coil			
C3089	K19149017	Ceramic CAP.		25WV	0.022uF	T3004	L0021736	Coil			
C3090	K40179013	AL. Electro. CAP.		50WV	1uF	T3005	L0021737	Coil			
						T3006	L0021736	Coil			
C3091	K19149021	Ceramic CAP.		25WV	0.047uF	T3007	L0021736	Coil			
C3093	K19149009	Ceramic CAP.		25WV	0.0047uF	T3009	L0190002	Coil			
C3094	K19149009	Ceramic CAP.		25WV	0.0047uF	T3010	L0021469	Coil			
C3095	K10179024	Ceramic CAP.	B	50WV	0.01uF	T3011	L0190002	Coil			
C3096	K12171102	Ceramic CAP.	E	50WV	0.001uF	T3012	L0190094	Coil			
C3097	K19149021	Ceramic CAP.		25WV	0.047uF	T3013	L0190094	Coil			
C3098	K00175101	Ceramic CAP.	SL	50WV	100pF	T3014	L0190094	Coil			
C3099	K40179013	AL. Electro. CAP.		50WV	1uF						
						L3001	L0021257	Coil			
C3100	K19149021	Ceramic CAP.		25WV	0.047uF	L3002	L0021257	Coil			
C3101	K40179013	AL. Electro. CAP.		50WV	1uF	L3003	L1190270	M.RFC		100uH	
						L3004	L1190270	M.RFC		100uH	
C3103	K19149025	Ceramic CAP.		25WV	0.1uF	L3005	L1190189	M.RFC		1mH	
C3104	K40109001	AL. Electro. CAP.		10WV	100uF	L3006	L1190189	M.RFC		1mH	
						L3007	L1190189	M.RFC		1mH	
15	K40179016	AL. Electro. CAP.		50WV	0.1uF	L3008	L1190189	M.RFC		1mH	
						L3009	L1190040	M.RFC		1mH	
C3106	K19149021	Ceramic CAP.		25WV	0.047uF	L3010	L1190040	M.RFC		1mH	
C3110	K19149021	Ceramic CAP.		25WV	0.047uF	L3011	L0021610	Coil		250uH	
C3111	K00173100	Ceramic CAP.	SL	50WV	10pF	L3012	L1190189	M.RFC		1mH	
C3112	K19149021	Ceramic CAP.		25WV	0.047uF	L3013	L1190266	M.RFC		47uH	
C3113	K19149021	Ceramic CAP.		25WV	0.047uF	L3014	L1190189	M.RFC		1mH	
C3114	K19149021	Ceramic CAP.		25WV	0.047uF	L3015	L1190189	M.RFC		1mH	
C3115	K13179008	Ceramic CAP.	F	50WV	0.01uF						
C3116	K40179004	AL. Electro. CAP.		16WV	10uF	J3001	P0090524	Connector			
						J3002	P0090525	Connector			
C3117	K19149021	Ceramic CAP.		25WV	0.047uF	J3003	P0090525	Connector			
C3118	K00175270	Ceramic CAP.	SL	50WV	27pF	J3004	P0090525	Connector			
C3119	K51176102	Styrol CAP.		50WV	0.001uF	J3005	P0090526	Connector			
C3120	K51176102	Styrol CAP.		50WV	0.001uF	J3006	P0090525	Connector			
C3121	K00175101	Ceramic CAP.	SL	50WV	100pF	J3007	P0090525	Connector			
C3122	K13179008	Ceramic CAP.	F	50WV	0.01uF	J3008	P0090525	Connector			
C3123	K13179008	Ceramic CAP.	F	50WV	0.01uF	J3009	P0090528	Connector			
C3124	K19149013	Ceramic CAP.		25WV	0.01uF	J3010	P0090524	Connector			
C3125	K00173100	Ceramic CAP.	SL	50WV	10pF	J3011	P0090525	Connector			
C3126	K19149021	Ceramic CAP.		25WV	0.047uF	J3012	P0090527	Connector			
C3127	K00175101	Ceramic CAP.	SL	50WV	100pF	J3013	P0090527	Connector			
C3128	K19149021	Ceramic CAP.		25WV	0.047uF	J3014	P0090524	Connector			
C3129	K13179008	Ceramic CAP.	F	50WV	0.01uF	J3015	P0090528	Connector			
C3130	K19149021	Ceramic CAP.		25WV	0.047uF	J3016	P0090524	Connector			
C3131	K19149021	Ceramic CAP.		25WV	0.047uF	J3017	P0090554	Connector (CAT)			
C3032	K70147155	Tantalum CAP.		25WV	1.5uF	J3018	P0090553	Connector (STBY)			

PARTS LIST

Q4019	G3304600B	Transistor	2SC460B	R4031	J02225332	Carbon Film RES.	1/6W	3.3k ohm	UJ
Q4020	G1090101	IC	uPC1037H	R4032	J02225103	Carbon Film RES.	1/6W	10k ohm	UJ
Q4021	G3304600B	Transistor	2SC460B	R4033	J01225153	Carbon Film RES.	1/6W	15k ohm	PJ
Q4022	G4800740L	FET	3SK74L	R4034	J01225103	Carbon Film RES.	1/6W	10k ohm	PJ
Q4023	G3304580C	Transistor	2SC458C	R4035	J01225104	Carbon Film RES.	1/6W	100k ohm	PJ
Q4024	G3801921G	FET	2SK192AGR	R4036	J01225101	Carbon Film RES.	1/6W	100 ohm	PJ
Q4025	G3107331Q	Transistor	2SA733AQ	R4037	J02225224	Carbon Film RES.	1/6W	220k ohm	UJ
Q4026	G1090278	IC	uPD4001BC	R4038	J02225222	Carbon Film RES.	1/6W	2.2k ohm	UJ
Q4027	G1090282	IC	uPD4011BC	R4039	J01225221	Carbon Film RES.	1/6W	220 ohm	UJ
Q4028	G3090074	Transistor	BA1A4M	R4040	J02225474	Carbon Film RES.	1/6W	470k ohm	UJ
Q4029	G3090075	Transistor	BN1A4P	R4041	J02225102	Carbon Film RES.	1/6W	1k ohm	UJ
Q4030	G3115280	Transistor	2SA1528	R4042	J02225104	Carbon Film RES.	1/6W	100k ohm	UJ
Q4031	G3090075	Transistor	BN1A4P	R4043	J02225332	Carbon Film RES.	1/6W	3.3k ohm	UJ
Q4032	G3304580C	Transistor	2SC458C	R4044	J02225273	Carbon Film RES.	1/6W	27k ohm	UJ
Q4033	G3115280	Transistor	2SA1528	R4045	J01225104	Carbon Film RES.	1/6W	100k ohm	PJ
Q4034	G3304580C	Transistor	2SC458C	R4046	J02225223	Carbon Film RES.	1/6W	22k ohm	UJ
Q4035	G3115280	Transistor	2SA1528	R4047	J02225223	Carbon Film RES.	1/6W	22k ohm	UJ
Q4036	G3304600B	Transistor	2SC460B	R4048	J02225103	Carbon Film RES.	1/6W	10k ohm	UJ
Q4037	G3304580C	Transistor	2SC458C	R4049	J02225101	Carbon Film RES.	1/6W	100 ohm	UJ
Q4038	G3090080	Transistor	BA1L4M	R4050	J01225223	Carbon Film RES.	1/6W	22k ohm	PJ
Q4039	G3090080	Transistor	BA1L4M	R4051	J01225474	Carbon Film RES.	1/6W	470k ohm	PJ
Q4040	G3090079	Transistor	BA1A4P	R4052	J02225223	Carbon Film RES.	1/6W	22k ohm	UJ
				R4053	J01225223	Carbon Film RES.	1/6W	22k ohm	PJ
D4001	G2022080	Diode	1S2208	R4054	J02225223	Carbon Film RES.	1/6W	22k ohm	UJ
D4002	G2022080	Diode	1S2208	R4055	J02225225	Carbon Film RES.	1/6W	2.2M ohm	UJ
D4003	G2090408	Diode	1SS270	R4056	J02225472	Carbon Film RES.	1/6W	4.7k ohm	UJ
D4004	G2090408	Diode	1SS270	R4057	J02225332	Carbon Film RES.	1/6W	3.3k ohm	UJ
D4005	G2090382	Diode	MC931	R4058	J02225102	Carbon Film RES.	1/6W	1k ohm	UJ
D4006	G2090408	Diode	1SS270	R4062	J02225562	Carbon Film RES.	1/6W	5.6k ohm	UJ
D4007	G2090408	Diode	1SS270	R4063	J02225562	Carbon Film RES.	1/6W	5.6k ohm	UJ
D4008	G2090408	Diode	1SS270	R4064	J02225562	Carbon Film RES.	1/6W	5.6k ohm	UJ
D4009	G2090027	Diode	1SS53	R4065	J01225223	Carbon Film RES.	1/6W	22k ohm	PJ
D4010	G2090027	Diode	1SS53	R4066	J02225223	Carbon Film RES.	1/6W	22k ohm	UJ
D4011	G2015880	Diode	1S1588	R4067	J01225560	Carbon Film RES.	1/6W	56 ohm	PJ
D4012	G2015880	Diode	1S1588	R4068	J02225102	Carbon Film RES.	1/6W	1k ohm	UJ
D4013	G2090381	Diode	MC921	R4069	J02225102	Carbon Film RES.	1/6W	1k ohm	UJ
D4014	G2090408	Diode	1SS270	R4070	J01225104	Carbon Film RES.	1/6W	100k ohm	PJ
D4015	G2090200	Diode	1SV80	R4071	J02225332	Carbon Film RES.	1/6W	3.3k ohm	UJ
D4016	G9090007	Varistor	MV-12	R4072	J02225560	Carbon Film RES.	1/6W	56 ohm	UJ
D4017	G2090408	Diode	1SS270	R4073	J01225560	Carbon Film RES.	1/6W	56 ohm	PJ
D4018	G2090408	Diode	1SS270	R4074	J01225473	Carbon Film RES.	1/6W	47k ohm	PJ
D4019	G2090408	Diode	1SS270	R4075	J02225473	Carbon Film RES.	1/6W	47k ohm	UJ
D4020	G2090383	Diode	MC911	R4076	J02225104	Carbon Film RES.	1/6W	100k ohm	UJ
D4022	G2090408	Diode	1SS270	R4077	J02225471	Carbon Film RES.	1/6W	470 ohm	UJ
D4023	G2090408	Diode	1SS270	R4078	J02225221	Carbon Film RES.	1/6W	220 ohm	UJ
				R4079	J02225681	Carbon Film RES.	1/6W	680 ohm	UJ
TH4002	G9090001	Thermistor		R4080	J02225224	Carbon Film RES.	1/6W	220k ohm	UJ
				R4081	J02225102	Carbon Film RES.	1/6W	1k ohm	UJ
X4001	H0102815	XTAL	HC-49/T 24.4885MHz	R4082	J02225330	Carbon Film RES.	1/6W	33 ohm	UJ
X4002	H9500100	XTAL OSC	GFS-203H 20.48MHz	R4083	J02225103	Carbon Film RES.	1/6W	10k ohm	UJ
				R4084	J02225472	Carbon Film RES.	1/6W	4.7k ohm	UJ
XF4001	H1102123	XTAL Filter	XF-10.7N-252-01	R4085	J02225102	Carbon Film RES.	1/6W	1k ohm	UJ
XF4002	H1102123	XTAL Filter	XF-10.7N-252-01	R4086	J02225102	Carbon Film RES.	1/6W	1k ohm	UJ
XF4003	H1102120	XTAL Filter	13N15A	R4087	J02225103	Carbon Film RES.	1/6W	10k ohm	UJ
				R4088	J02225102	Carbon Film RES.	1/6W	1k ohm	UJ
CF4001	H3900393	Ceramic Filter	SFE10.7MS2-A	R4089	J02225101	Carbon Film RES.	1/6W	100 ohm	UJ
				R4090	J02225560	Carbon Film RES.	1/6W	56 ohm	UJ
R4001	J01225104	Carbon Film RES.	1/6W 100k ohm	PJ	R4091	J02225274	Carbon Film RES.	1/6W 270k ohm	UJ
R4002	J02225103	Carbon Film RES.	1/6W 10k ohm	UJ	R4092	J02225152	Carbon Film RES.	1/6W 1.5k ohm	UJ
R4003	J02225101	Carbon Film RES.	1/6W 100 ohm	UJ	R4093	J02225272	Carbon Film RES.	1/6W 2.7k ohm	UJ
R4004	J02225333	Carbon Film RES.	1/6W 33k ohm	UJ	R4094	J02225272	Carbon Film RES.	1/6W 2.7k ohm	UJ
R4005	J02225473	Carbon Film RES.	1/6W 47k ohm	UJ	R4095	J01225223	Carbon Film RES.	1/6W 22k ohm	PJ
R4006	J01225223	Carbon Film RES.	1/6W 22k ohm	PJ	R4096	J01225104	Carbon Film RES.	1/6W 100k ohm	PJ
R4007	J02225102	Carbon Film RES.	1/6W 1k ohm	UJ	R4100	J01225153	Carbon Film RES.	1/6W 15k ohm	PJ
R4008	J02225223	Carbon Film RES.	1/6W 22k ohm	UJ	R4101	J01225331	Carbon Film RES.	1/6W 330 ohm	PJ
R4009	J02225101	Carbon Film RES.	1/6W 100 ohm	UJ	R4102	J02225222	Carbon Film RES.	1/6W 2.2k ohm	UJ
R4010	J02225102	Carbon Film RES.	1/6W 1k ohm	UJ	R4103	J01225332	Carbon Film RES.	1/6W 3.3k ohm	PJ
R4011	J02225154	Carbon Film RES.	1/6W 150k ohm	UJ	R4104	J02225105	Carbon Film RES.	1/6W 1M ohm	UJ
R4012	J02225221	Carbon Film RES.	1/6W 220 ohm	UJ	R4105	J02225103	Carbon Film RES.	1/6W 10k ohm	UJ
R4013	J02225334	Carbon Film RES.	1/6W 330k ohm	UJ	R4106	J01225155	Carbon Film RES.	1/6W 1.5M ohm	PJ
R4014	J02225103	Carbon Film RES.	1/6W 10k ohm	UJ	R4107	J02225183	Carbon Film RES.	1/6W 18k ohm	UJ
R4015	J02225101	Carbon Film RES.	1/6W 100 ohm	UJ	R4109	J02225102	Carbon Film RES.	1/6W 1k ohm	UJ
R4016	J02225472	Carbon Film RES.	1/6W 4.7k ohm	UJ	R4110	J02225334	Carbon Film RES.	1/6W 330k ohm	UJ
R4017	J02225474	Carbon Film RES.	1/6W 470k ohm	UJ	R4111	J02225223	Carbon Film RES.	1/6W 22k ohm	UJ
R4018	J02225473	Carbon Film RES.	1/6W 47k ohm	UJ	R4112	J01225334	Carbon Film RES.	1/6W 330k ohm	PJ
R4019	J02225682	Carbon Film RES.	1/6W 6.8k ohm	UJ	R4113	J01225155	Carbon Film RES.	1/6W 1.5M ohm	PJ
R4020	J02225684	Carbon Film RES.	1/6W 680k ohm	UJ	R4114	J02225274	Carbon Film RES.	1/6W 270k ohm	UJ
R4021	J02225682	Carbon Film RES.	1/6W 6.8k ohm	UJ	R4115	J02225473	Carbon Film RES.	1/6W 47k ohm	UJ
R4022	J02225473	Carbon Film RES.	1/6W 47k ohm	UJ	R4116	J02225155	Carbon Film RES.	1/6W 1.5M ohm	UJ
R4023	J02225103	Carbon Film RES.	1/6W 10k ohm	UJ	R4117	J02225134	Carbon Film RES.	1/6W 130k ohm	UJ
R4024	J02225513	Carbon Film RES.	1/6W 51k ohm	UJ	R4118	J02225333	Carbon Film RES.	1/6W 33k ohm	UJ
R4025	J02225513	Carbon Film RES.	1/6W 51k ohm	UJ	R4120	J02225332	Carbon Film RES.	1/6W 3.3k ohm	UJ
R4026	J02225225	Carbon Film RES.	1/6W 2.2M ohm	UJ	R4121	J02225473	Carbon Film RES.	1/6W 47k ohm	UJ
R4027	J02225183	Carbon Film RES.	1/6W 18k ohm	UJ	R4124	J02225103	Carbon Film RES.	1/6W 10k ohm	UJ
R4028	J01225183	Carbon Film RES.	1/6W 18k ohm	PJ	R4125	J02225472	Carbon Film RES.	1/6W 4.7k ohm	UJ
R4029	J01225225	Carbon Film RES.	1/6W 2.2M ohm	PJ	R4126	J02225472	Carbon Film RES.	1/6W 4.7k ohm	UJ
R4030	J01225472	Carbon Film RES.	1/6W 4.7k ohm	PJ	R4127	J01225472	Carbon Film RES.	1/6W 4.7k ohm	PJ

PARTS LIST

R4128	J02225103	Carbon Film RES.	1/6W	10k ohm	UJ						
R4129	J01225471	Carbon Film RES.	1/6W	470 ohm	PJ						
R4130	J01225470	Carbon Film RES.	1/6W	47 ohm	PJ						
R4131	J02225223	Carbon Film RES.	1/6W	22k ohm	UJ						
R4132	J02225222	Carbon Film RES.	1/6W	2.2k ohm	UJ						
R4133	J02225222	Carbon Film RES.	1/6W	2.2k ohm	UJ						
R4136	J02225221	Carbon Film RES.	1/6W	220 ohm	UJ						
R4137	J02225472	Carbon Film RES.	1/6W	4.7k ohm	UJ						
R4138	J02225683	Carbon Film RES.	1/6W	68k ohm	UJ						
R4139	J02225682	Carbon Film RES.	1/6W	6.8k ohm	UJ						
R4140	J02225471	Carbon Film RES.	1/6W	470 ohm	UJ						
R4141	J01225223	Carbon Film RES.	1/6W	22k ohm	PJ						
R4142	J01225102	Carbon Film RES.	1/6W	1k ohm	PJ						
R4143	J01225471	Carbon Film RES.	1/6W	470 ohm	PJ						
R4144	J01225471	Carbon Film RES.	1/6W	470 ohm	PJ						
R4145	J01225100	Carbon Film RES.	1/6W	10 ohm	PJ						
VR4001	J51745473	POT.	B	47k ohm							
VR4003	J51745104	POT.	B	100k ohm							
VR4004	J51745103	POT.	B	10k ohm							
C4001	K19149013	Ceramic CAP.		25WV	0.01uF						
C4002	K05173100	Ceramic CAP.	RH	50WV	10pF						
C4003	K02172040	Ceramic CAP.	CH	50WV	4pF						
C4004	K40109001	AL. Electro. CAP.		10WV	100uF						
C4005	K02175101	Ceramic CAP.	CH	50WV	100pF						
C4006	K05175220	Ceramic CAP.	RH	50WV	22pF						
C4007	K05175151	Ceramic CAP.	RH	50WV	150pF						
C4008	K05175151	Ceramic CAP.	RH	50WV	150pF						
C4009	K40109001	AL. Electro. CAP.		10WV	100uF						
C4010	K13179010	Ceramic CAP.	F	50WV	0.022uF						
C4012	K40109001	AL. Electro. CAP.		10WV	100uF						
C4013	K12171102	Ceramic CAP.	E	50WV	0.001uF						
C4014	K12171102	Ceramic CAP.	E	50WV	0.001uF						
C4015	K40179013	AL. Electro. CAP.		50WV	1uF						
C4016	K40109001	AL. Electro. CAP.		10WV	100uF						
C4017	K13179010	Ceramic CAP.	F	50WV	0.022uF						
C4018	K40179016	AL. Electro. CAP.		50WV	0.1uF						
C4019	K19149007	Ceramic CAP.		25WV	0.0033uF						
C4020	K19149025	Ceramic CAP.		25WV	0.1uF						
C4021	K70167224	Tantalum CAP.		35WV	0.22uF						
C4022	K70167224	Tantalum CAP.		35WV	0.22uF						
C4023	K19149002	Ceramic CAP.		25WV	0.0012uF						
C4024	K19149001	Ceramic CAP.		25WV	0.001uF						
C4025	K19149013	Ceramic CAP.		25WV	0.01uF						
C4026	K19149002	Ceramic CAP.		25WV	0.0012uF						
C4027	K40129004	AL. Electro. CAP.		16WV	10uF						
C4028	K12171102	Ceramic CAP.	E	50WV	0.001uF						
C4029	K40179013	AL. Electro. CAP.		50WV	1uF						
C4030	K40179013	AL. Electro. CAP.		50WV	1uF						
C4032	K40129004	AL. Electro. CAP.		16WV	10uF						
C4033	K19149025	Ceramic CAP.		25WV	0.1uF						
C4034	K40179012	AL. Electro. CAP.		50WV	4.7uF						
C4035	K40129004	AL. Electro. CAP.		16WV	10uF						
C4036	K70147105	Tantalum CAP.		25WV	1uF						
C4037	K00175150	Ceramic CAP.	SL	50WV	15pF						
C4038	K13179010	Ceramic CAP.	F	50WV	0.022uF						
C4039	K00173100	Ceramic CAP.	SL	50WV	10pF						
C4040	K00172020	Ceramic CAP.	SL	50WV	2pF						
C4041	K00175151	Ceramic CAP.	SL	50WV	150pF						
C4042	K13179010	Ceramic CAP.	F	50WV	0.022uF						
C4043	K13179010	Ceramic CAP.	F	50WV	0.022uF						
C4044	K13179010	Ceramic CAP.	F	50WV	0.022uF						
C4045	K12171102	Ceramic CAP.	E	50WV	0.001uF						
C4046	K13179010	Ceramic CAP.	F	50WV	0.022uF						
C4047	K40179013	AL. Electro. CAP.		50WV	1uF						
C4048	K19149025	Ceramic CAP.		25WV	0.1uF						
C4049	K19149009	Ceramic CAP.		25WV	0.004uF						
C4050	K19149003	Ceramic CAP.		25WV	0.0015uF						
C4051	K12171102	Ceramic CAP.	E	50WV	0.001uF						
C4052	K40129004	AL. Electro. CAP.		16WV	10uF						
C4053	K40179012	AL. Electro. CAP.		50WV	4.7uF						
C4057	K05172050	Ceramic CAP.	RH	50WV	5pF						
C4058	K05175220	Ceramic CAP.	RH	50WV	22pF						
C4059	K05175151	Ceramic CAP.	RH	50WV	150pF						
C4060	K05175151	Ceramic CAP.	RH	50WV	150pF						
C4061	K13179010	Ceramic CAP.	F	50WV	0.022uF						
C4062	K00175220	Ceramic CAP.	SL	50WV	22pF						
C4063	K13179010	Ceramic CAP.	F	50WV	0.022uF						
C4064	K13179010	Ceramic CAP.	F	50WV	0.022uF						
C4065	K00175220	Ceramic CAP.	SL	50WV	22pF						
C4066	K13179010	Ceramic CAP.	F	50WV	0.022uF						
C4067	K13179010	Ceramic CAP.	F	50WV	0.022uF						
C4068	K13179010	Ceramic CAP.	F	50WV	0.022uF						
C4069	K12171102	Ceramic CAP.	E	50WV	0.001uF						
C4070	K13179010	Ceramic CAP.	F	50WV	0.022uF						
C4071	K12171102	Ceramic CAP.	E	50WV	0.001uF						
C4072	K13179008	Ceramic CAP.	F	50WV	0.01uF						
C4073	K12171102	Ceramic CAP.	E	50WV	0.001uF						
C4074	K12171102	Ceramic CAP.	E	50WV	0.001uF						
C4075	K13179008	Ceramic CAP.	F	50WV	0.01uF						
C4076	K12171102	Ceramic CAP.	E	50WV	0.001uF						
C4077	K13179010	Ceramic CAP.	F	50WV	0.022uF						
C4078	K13179010	Ceramic CAP.	F	50WV	0.022uF						
C4079	K13179008	Ceramic CAP.	F	50WV	0.01uF						
C4080	K12171102	Ceramic CAP.	E	50WV	0.001uF						
C4081	K12171102	Ceramic CAP.	E	50WV	0.001uF						
C4082	K40109002	AL. Electro. CAP.		10WV	47uF						
C4083	K13179010	Ceramic CAP.	F	50WV	0.022uF						
C4084	K13179010	Ceramic CAP.	F	50WV	0.022uF						
C4085	K12171102	Ceramic CAP.	E	50WV	0.001uF						
C4086	K13179014	Ceramic CAP.	F	50WV	0.0047uF						
C4087	K12171102	Ceramic CAP.	E	50WV	0.001uF						
C4088	K12171102	Ceramic CAP.	E	50WV	0.001uF						
C4089	K12171102	Ceramic CAP.	E	50WV	0.001uF						
C4090	K70147105	Tantalum CAP.		25WV	1uF						
C4091	K40109001	AL. Electro. CAP.		10WV	100uF						
C4092	K13179010	Ceramic CAP.	F	50WV	0.022uF						
C4093	K70127225	Tantalum CAP.		16WV	2.2uF						
C4094	K70107475	Tantalum CAP.		10WV	4.7uF						
C4095	K55209003	Film CAP.		10WV	0.0047uF						
C4100	K12171102	Ceramic CAP.	E	50WV	0.001uF						
C4101	K40129004	AL. Electro. CAP.		16WV	10uF						
C4102	K40179013	AL. Electro. CAP.		50WV	1uF						
C4103	K40179016	AL. Electro. CAP.		50WV	0.1uF						
C4104	K70147105	Tantalum CAP.		10WV	1uF						
C4105	K40179013	AL. Electro. CAP.		50WV	1uF						
C4108	K13179010	Ceramic CAP.	F	50WV	0.022uF						
C4109	K13179010	Ceramic CAP.	F	50WV	0.022uF						
C4110	K12171102	Ceramic CAP.	E	50WV	0.001uF						
C4111	K13179010	Ceramic CAP.	F	50WV	0.022uF						
C4112	K12171102	Ceramic CAP.	E	50WV	0.001uF						
C4113	K13179010	Ceramic CAP.	F	50WV	0.022uF						
C4114	K13179009	Ceramic CAP.	F	50WV	0.047uF						
C4116	K12171102	Ceramic CAP.	E	50WV	0.001uF						
C4117	K02175121	Ceramic CAP.	CH	50WV	120uF						
C4118	K02175121	Ceramic CAP.	CH	50WV	120uF						
C4119	K40129054	AL. Electro. CAP.		16WV	47uF						
C4120	K00175101	Ceramic CAP.	SL	50WV	100pF						
C4121	K70107475	Tantalum CAP.		10WV	4.7uF						
C4122	K70107685	Tantalum CAP.		10WV	6.8uF						
C4123	K40129012	AL. Electro. CAP.		16WV	10uF						
C4124	K19149021	Ceramic CAP.		25WV	0.047uF						
C4125	K19149021	Ceramic CAP.		25WV	0.047uF						
TC4001	K91000028	Variable CAP.			10pF						
T4001	L0021533	Coil									
T4002	L0021736	Coil									
T4003	L0021736	Coil									
L4001	L1190189	M. RFC			1mH						
L4002	L0020533	Coil									
L4003	L1190262	M. RFC			22uH						
L4004	L1190258	M. RFC			10uH						
L4005	L1190274	M. RFC			220uH						
L4006	L1190274	M. RFC			220uH						
L4008	L1190244	M. RFC			0.68uH						
J4001	P0090524	Connector									
J4002	P0090532	Connector									

PARTS LIST

J4003	P0090526	Connector					
J4004	P0090529	Connector					
J4005	P0090524	Connector					
J4006	P0090527	Connector					
J4007	P0090524	Connector					
J4008	P0090526	Connector					
J4009	P0090527	Connector					
J4010	P0090528	Connector					
J4011	P0090524	Connector					
P4001	P0090606	Connector					
	R0121120	Shield Case					
VOX AMP UNIT							
Symbol No.	Part No.	Description	Device				
	F2892102	Printed Circuit Board					
	C028922AA	PCB with Components					
Q9901	G1090559	IC	LA6324M				
Q9902	G3327127G	Transistor	2SC2712GR TE85R				
Q9903	G3327127G	Transistor	2SC2712GR TE85R				
D9901	G2070003	Diode	1SS226 TE85R				
P9901	J24205683	RES. Chip	1/10W 68k ohm				
9902	J24205472	RES. Chip	1/10W 4.7k ohm				
9903	J24205474	RES. Chip	1/10W 470k ohm				
R9904	J24205103	RES. Chip	1/10W 10k ohm				
R9905	J24205104	RES. Chip	1/10W 100k ohm				
R9906	J24205472	RES. Chip	1/10W 4.7k ohm				
R9907	J24205474	RES. Chip	1/10W 470k ohm				
R9908	J24205472	RES. Chip	1/10W 4.7k ohm				
R9909	J24205474	RES. Chip	1/10W 470k ohm				
R9910	J24205472	RES. Chip	1/10W 4.7k ohm				
R9911	J24205472	RES. Chip	1/10W 4.7k ohm				
R9912	J24205472	RES. Chip	1/10W 4.7k ohm				
R9913	J24205472	RES. Chip	1/10W 4.7k ohm				
R9914	J24205000	RES. Chip	1/10W 0 ohm				
C9901	K22141904	CAP. Chip	D 25WV 0.1uF				
C9902	K22141904	CAP. Chip	D 25WV 0.1uF				
C9903	K22170817	CAP. Chip	B 50WV 0.01uF				
	Q5000057	Lead Frame					
13MHz TX PLL UNIT							
Symbol No.	Part No.	Description	Device				
	F2892110A	Printed Circuit Board					
	C02892AAA	PCB with Components					
Q9701	G1090739	IC	MC145163SL				
Q9702	G3326197B	Transistor	2SC2619FBTR				
9703	G3326197B	Transistor	2SC2619FBTR				
R9701	J24205102	RES. Chip	1/10W 1k ohm				
R9702	J24205332	RES. Chip	1/10W 3.3k ohm				
R9703	J24205104	RES. Chip	1/10W 100k ohm				
R9704	J24205102	RES. Chip	1/10W 1k ohm				
R9705	J24205472	RES. Chip	1/10W 4.7k ohm				
R9706	J24205103	RES. Chip	1/10W 10k ohm				
R9707	J24205102	RES. Chip	1/10W 1k ohm				
R9708	J24205104	RES. Chip	1/10W 100k ohm				
C9701	K22170817	CAP. Chip	B 50WV 0.01uF				
C9702	K22170817	CAP. Chip	B 50WV 0.01uF				
C9703	K22170817	CAP. Chip	B 50WV 0.01uF				
C9704	K22170203	CAP. Chip	CH 50WV 2PF				
C9705	K22170817	CAP. Chip	B 50WV 0.01uF				
C9706	K22170817	CAP. Chip	B 50WV 0.01uF				
	Q5000057	Lead Frame					
AF UNIT							
Symbol No.	Part No.	Description	Device				
	F2887103A	Printed Circuit Board					
	C028873AA	PCB with Components					
Q5001	G3304600B	Transistor	2SC460B				
Q5002	G3304600B	Transistor	2SC460B				
Q5003	G3304600B	Transistor	2SC460B				
Q5004	G3304600B	Transistor	2SC460B				
Q5005	G3304600B	Transistor	2SC460B				
Q5006	G1090164	IC	uPC2002H				
Q5008	G3304580C	Transistor	2SC458C				
Q5009	G3304580C	Transistor	2SC458C				
Q5010	G1090080	IC	uPC78L08				
R5001	J02225153	Carbon Film RES.	1/6W 15k ohm	UJ			
R5002	J02225223	Carbon Film RES.	1/6W 22k ohm	UJ			
R5003	J02225471	Carbon Film RES.	1/6W 470 ohm	UJ			
R5004	J02225153	Carbon Film RES.	1/6W 15k ohm	UJ			
R5005	J02225223	Carbon Film RES.	1/6W 22k ohm	UJ			
R5006	J02225471	Carbon Film RES.	1/6W 470 ohm	UJ			
R5007	J02225153	Carbon Film RES.	1/6W 15k ohm	UJ			
R5008	J02225223	Carbon Film RES.	1/6W 22k ohm	UJ			
R5009	J02225471	Carbon Film RES.	1/6W 470 ohm	UJ			
R5010	J02225153	Carbon Film RES.	1/6W 15k ohm	UJ			
R5011	J02225223	Carbon Film RES.	1/6W 22k ohm	UJ			
R5012	J02225471	Carbon Film RES.	1/6W 470 ohm	UJ			
R5013	J02225153	Carbon Film RES.	1/6W 15k ohm	UJ			
R5014	J02225223	Carbon Film RES.	1/6W 22k ohm	UJ			
R5015	J02225471	Carbon Film RES.	1/6W 470 ohm	UJ			
R5016	J02225680	Carbon Film RES.	1/6W 68 ohm	UJ			
R5018	J02225103	Carbon Film RES.	1/6W 10k ohm	UJ			
R5019	J02225223	Carbon Film RES.	1/6W 22k ohm	UJ			
R5020	J02225104	Carbon Film RES.	1/6W 100k ohm	UJ			
R5021	J02225104	Carbon Film RES.	1/6W 100k ohm	UJ			
R5022	J02275221	Carbon Film RES.	1/2W 220 ohm	VJ			
R5023	J02245229	Carbon Film RES.	1/4W 2.2 ohm	SJ			
R5024	J02245010	Carbon Film RES.	1/4W 1 ohm	SJ			
R5026	J02225102	Carbon Film RES.	1/6W 1k ohm	UJ			
R5027	J02225472	Carbon Film RES.	1/6W 4.7k ohm	UJ			
R5028	J02245229	Carbon Film RES.	1/4W 2.2 ohm	SJ			
R5029	J02225332	Carbon Film RES.	1/6W 3.3k ohm	UJ			
R5030	J02245010	Carbon Film RES.	1/4W 1 ohm	SJ			
C5001	K12171102	Ceramic CAP.	E 50WV 0.001uF				
C5002	K12171102	Ceramic CAP.	E 50WV 0.001uF				
C5003	K12171102	Ceramic CAP.	E 50WV 0.001uF				
C5004	K12171102	Ceramic CAP.	E 50WV 0.001uF				
C5005	K12171102	Ceramic CAP.	E 50WV 0.001uF				
C5006	K12171102	Ceramic CAP.	E 50WV 0.001uF				
C5007	K12171102	Ceramic CAP.	E 50WV 0.001uF				
C5008	K12171102	Ceramic CAP.	E 50WV 0.001uF				
C5009	K12171102	Ceramic CAP.	E 50WV 0.001uF				
C5010	K12171102	Ceramic CAP.	E 50WV 0.001uF				
C5011	K19149017	Ceramic CAP.	25WV 0.022uF				
C5012	K12171102	Ceramic CAP.	E 50WV 0.001uF				
C5013	K40179013	AL. Electro. CAP.	50WV 1uF				
C5014	K01175101	Ceramic CAP.	SL 50WV 100pF				
C5015	K12171102	Ceramic CAP.	E 50WV 0.001uF				
C5016	K40109007	AL. Electro. CAP.	10WV 220uF				
C5017	K40109012	AL. Electro. CAP.	10WV 1000uF				
C5018	K19149025	Ceramic CAP.	25WV 0.1uF				
C5019	K12171102	Ceramic CAP.	E 50WV 0.001uF				
C5020	K40129050	AL. Electro. CAP.	16WV 2200uF				
C5022	K40129004	AL. Electro. CAP.	16WV 10uF				
C5024	K40129004	AL. Electro. CAP.	16WV 10uF				
C5025	K12171102	Ceramic CAP.	E 50WV 0.001uF				
C5026	K12171102	Ceramic CAP.	E 50WV 0.001uF				
C5029	K13179010	Ceramic CAP.	F 50WV 0.022uF				
C5030	K13179010	Ceramic CAP.	F 50WV 0.022uF				
C5031	K13179010	Ceramic CAP.	F 50WV 0.022uF				
C5032	K19129013	Ceramic CAP.	25WV 0.01uF				
J5001	P0090525	Connector					
J5002	P0090524	Connector					
J5003	P0090524	Connector					
J5004	P0090526	Connector					
J5005	P0090525	Connector					
J5006	P0090524	Connector					
J5007	P0090524	Connector					
J5008	P0090524	Connector					
J5009	P0090524	Connector					
J5010	P0090535	Connector					
J5011	P0090535	Connector					
J5012	P0090535	Connector					
J5013	P0090535	Connector					

PARTS LIST

J5014	P0090525	Connector		X6001	H0102814	XTAL	HC-48/T 20.5043MHz
J5015	P0090527	Connector					
J5016	P0090429	Connector		XF6001	H1102126	XTAL Filter	13M20A
J5017	P0090429	Connector					
J5018	P0090429	Connector		R6001	J02225473	Carbon Film RES.	1/6W 47k ohm UJ
J5019	P0090429	Connector		R6002	J02225470	Carbon Film RES.	1/6W 47 ohm UJ
J5020	P0090525	Connector		R6003	J02225225	Carbon Film RES.	1/6W 2.2M ohm UJ
	R0087040A	AF Heatshink		R6004	J02225470	Carbon Film RES.	1/6W 47 ohm UJ
	R0102810	Nut Board		R6005	J02225102	Carbon Film RES.	1/6W 1K ohm UJ
				R6006	J02225331	Carbon Film RES.	1/6W 330 ohm UJ
				R6007	J02225180	Carbon Film RES.	1/6W 18 ohm UJ
				R6008	J02225331	Carbon Film RES.	1/6W 330 ohm UJ
				R6009	J02225473	Carbon Film RES.	1/6W 47k ohm UJ
				R6010	J02225470	Carbon Film RES.	1/6W 47 ohm UJ
				R6011	J02225473	Carbon Film RES.	1/6W 47k ohm UJ
				R6012	J02225473	Carbon Film RES.	1/6W 47k ohm UJ
				R6013	J02225470	Carbon Film RES.	1/6W 47 ohm UJ
				R6014	J02225680	Carbon Film RES.	1/6W 68 ohm UJ
				R6015	J02225681	Carbon Film RES.	1/6W 68 ohm UJ
				R6016	J02225680	Carbon Film RES.	1/6W 68 ohm UJ
				R6017	J02225221	Carbon Film RES.	1/6W 220 ohm UJ
				R6018	J02225101	Carbon Film RES.	1/6W 100 ohm UJ
				R6019	J02225101	Carbon Film RES.	1/6W 100 ohm UJ
				R6020	J02225470	Carbon Film RES.	1/6W 47 ohm UJ
				R6021	J02225560	Carbon Film RES.	1/6W 56 ohm UJ
				R6022	J01225473	Carbon Film RES.	1/6W 47k ohm PJ
				R6023	J01225473	Carbon Film RES.	1/6W 47k ohm PJ
				R6024	J02225104	Carbon Film RES.	1/6W 100k ohm UJ
				R6025	J02225104	Carbon Film RES.	1/6W 100k ohm U
				R6026	J02225101	Carbon Film RES.	1/6W 100 ohm U
				R6027	J02225104	Carbon Film RES.	1/6W 100k ohm UJ
				R6028	J02225104	Carbon Film RES.	1/6W 100k ohm UJ
				R6029	J02225104	Carbon Film RES.	1/6W 100k ohm UJ
				R6030	J01225104	Carbon Film RES.	1/6W 100k ohm PJ
				R6031	J01225561	Carbon Film RES.	1/6W 560 ohm PJ
				R6032	J02225221	Carbon Film RES.	1/6W 220 ohm UJ
				R6033	J02225220	Carbon Film RES.	1/6W 22 ohm UJ
				R6034	J01225479	Carbon Film RES.	1/6W 4.7 ohm PJ
				R6035	J02225821	Carbon Film RES.	1/6W 820 ohm UJ
				R6036	J02225474	Carbon Film RES.	1/6W 470k ohm UJ
				R6037	J02225101	Carbon Film RES.	1/6W 100 ohm UJ
				R6038	J02225101	Carbon Film RES.	1/6W 100 ohm UJ
				R6039	J02225473	Carbon Film RES.	1/6W 47k ohm UJ
				R6040	J02225223	Carbon Film RES.	1/6W 22k ohm UJ
				R6041	J02225103	Carbon Film RES.	1/6W 10k ohm UJ
				R6042	J01225221	Carbon Film RES.	1/6W 220 ohm PJ
				R6043	J02225104	Carbon Film RES.	1/6W 100k ohm UJ
				R6044	J01225562	Carbon Film RES.	1/6W 5.6k ohm PJ
				R6045	J01225103	Carbon Film RES.	1/6W 10k ohm PJ
				R6046	J02225560	Carbon Film RES.	1/6W 56 ohm UJ
				R6047	J02225222	Carbon Film RES.	1/6W 2.2k ohm UJ
				R6048	J02225222	Carbon Film RES.	1/6W 2.2k ohm UJ
				R6049	J02225473	Carbon Film RES.	1/6W 47k ohm UJ
				R6050	J02225471	Carbon Film RES.	1/6W 470 ohm UJ
				R6051	J01225223	Carbon Film RES.	1/6W 22k ohm PJ
				R6052	J02225562	Carbon Film RES.	1/6W 5.6k ohm UJ
				R6053	J02225102	Carbon Film RES.	1/6W 1k ohm UJ
				R6054	J02225473	Carbon Film RES.	1/6W 47k ohm UJ
				R6055	J02225470	Carbon Film RES.	1/6W 47 ohm UJ
				R6056	J01225471	Carbon Film RES.	1/6W 470 ohm UJ
				R6057	J01225103	Carbon Film RES.	1/6W 10k ohm PJ
				R6058	J01225222	Carbon Film RES.	1/6W 2.2k ohm UJ
				R6059	J02225681	Carbon Film RES.	1/6W 680 ohm UJ
				R6060	J02225471	Carbon Film RES.	1/6W 470 ohm UJ
				R6061	J02225102	Carbon Film RES.	1/6W 1k ohm UJ
				R6062	J02225102	Carbon Film RES.	1/6W 1k ohm UJ
				R6064	J02225103	Carbon Film RES.	1/6W 10k ohm UJ
				R6065	J02225332	Carbon Film RES.	1/6W 3.3k ohm UJ
				R6066	J02225101	Carbon Film RES.	1/6W 100 ohm UJ
				R6067	J02225332	Carbon Film RES.	1/6W 3.3k ohm UJ
				R6068	J02225103	Carbon Film RES.	1/6W 10k ohm UJ
				R6069	J02225681	Carbon Film RES.	1/6W 680 ohm UJ
				R6071	J02225101	Carbon Film RES.	1/6W 100 ohm UJ
				R6072	J02225222	Carbon Film RES.	1/6W 2.2k ohm UJ
				R6073	J01225151	Carbon Film RES.	1/6W 150 ohm PJ
				R6074	J02225222	Carbon Film RES.	1/6W 2.2k ohm UJ
				R6075	J02225471	Carbon Film RES.	1/6W 470 ohm UJ
				R6076	J01225102	Carbon Film RES.	1/6W 1k ohm PJ
				R6088	J02225560	Carbon Film RES.	1/6W 56 ohm UJ
				R6089	J02225101	Carbon Film RES.	1/6W 100 ohm UJ
				R6090	J02225332	Carbon Film RES.	1/6W 3.3k ohm UJ
				R6091	J02225222	Carbon Film RES.	1/6W 2.2k ohm UJ
				R6092	J02225104	Carbon Film RES.	1/6W 100k ohm UJ
				R6093	J01225472	Carbon Film RES.	1/6W 4.7k ohm PJ
				R6094	J02225333	Carbon Film RES.	1/6W 33k ohm UJ
				R6095	J02225473	Carbon Film RES.	1/6W 47k ohm UJ

Version	PCB with Components w/o 144MHz ALC UNIT, 144MHz SHIFT UNIT, 144MHz SUB VCO UNIT	PCB with Components w/o 144MHz ALC UNIT, 144MHz SHIFT UNIT, 144MHz SUB VCO UNIT	Version	PCB with Components w/o 144MHz ALC UNIT, 144MHz SHIFT UNIT, 144MHz SUB VCO UNIT	PCB with Components w/o 144MHz ALC UNIT, 144MHz SHIFT UNIT, 144MHz SUB VCO UNIT
A1,H2	C028881AA	C028881AJ	B3,C3	C028881AE	C028881AF
A2,H3	C028881AB	C028881AK	CT	C028881AG	C028881AP
B1	C028881AC	C028881AL	F	C028881AH	C028881AQ
B2,C2	C028881AD	C028881AM	H1	C028881AI	C028881AR

PARTS LIST

R6096	J01225102	Carbon Film RES.	1/6W	1k ohm	PJ	C6051	K40129004	AL. Electro. CAP.		16WV	10uF
R6097	J02225101	Carbon Film RES.	1/6W	100 ohm	UJ	C6052	K22170204	CAP. Chip		50WV	3pF
R6098	J02225473	Carbon Film RES.	1/6W	47k ohm	UJ	C6053	K13179008	Ceramic CAP.	F	50WV	0.01uF
R6099	J01225223	Carbon Film RES.	1/6W	22k ohm	PJ	C6054	K12171102	Ceramic CAP.	E	50WV	0.01uF
R6100	J02225562	Carbon Film RES.	1/6W	5.6k ohm	UJ	C6055	K12171102	Ceramic CAP.	E	50WV	0.01uF
R6101	J01225331	Carbon Film RES.	1/6W	330 ohm	PJ	C6056	K06173070	Ceramic CAP.	UJ	50WV	7pF
R6102	J01225101	Carbon Film RES.	1/6W	100 ohm	PJ	C6057	K02173060	Ceramic CAP.	CH	50WV	6pF
R6103	J02225560	Carbon Film RES.	1/6W	56 ohm	UJ	C6058	K05172050	Ceramic CAP.	RJ	50WV	5pF
R6104	J01225223	Carbon Film RES.	1/6W	22k ohm	PJ	C6059	K06172050	Ceramic CAP.	UJ	50WV	5pF
R6105	J01225682	Carbon Film RES.	1/6W	6.8k ohm	PJ	C6060	K40109001	AL. Electro. CAP.		10WV	100uF
R6106	J01225331	Carbon Film RES.	1/6W	330 ohm	PJ	C6061	K12171102	Ceramic CAP.	E	50WV	0.001uF
R6107	J01225101	Carbon Film RES.	1/6W	100 ohm	PJ	C6062	K02172020	Ceramic CAP.	CK	50WV	2pF
R6108	J01225331	Carbon Film RES.	1/6W	330 ohm	PJ	C6063	K13179014	Ceramic CAP.	F	50WV	0.0047uF
R6109	J02225101	Carbon Film RES.	1/6W	100 ohm	UJ	C6064	K00172040	Ceramic CAP.	SL	50WV	4pF
R6110	J02225471	Carbon Film RES.	1/6W	470 ohm	UJ	C6065	K13179008	Ceramic CAP.	F	50WV	0.01uF
R6111	J02225223	Carbon Film RES.	1/6W	22k ohm	UJ	C6066	K00173070	Ceramic CAP.	SL	50WV	7pF
R6112	J02225562	Carbon Film RES.	1/6W	5.6k ohm	UJ	C6067	K02179001	Ceramic CAP.	CK	50WV	1pF
R6113	J02225331	Carbon Film RES.	1/6W	330 ohm	UJ	C6068	K13179008	Ceramic CAP.	F	50WV	0.01uF
R6114	J02225102	Carbon Film RES.	1/6W	1k ohm	UJ	C6069	K12171102	Ceramic CAP.	E	50WV	0.001uF
R6115	J02225103	Carbon Film RES.	1/6W	1M ohm	UJ	C6070	K12171102	Ceramic CAP.	E	50WV	0.001uF
R6116	J02225103	Carbon Film RES.	1/6W	10k ohm	UJ	C6071	K13179008	Ceramic CAP.	F	50WV	0.01uF
R6117	J01225471	Carbon Film RES.	1/2W	470 ohm	TJ	C6072	K02172059	Ceramic CAP.	CK	50WV	0.5pF
R6118	J02225103	Carbon Film RES.	1/6W	10k ohm	UJ	C6073	K13179014	Ceramic CAP.	F	50WV	0.0047uF
R6119	J01225471	Carbon Film RES.	1/6W	470 ohm	PJ	C6074	K02172040	Ceramic CAP.	CH	50WV	4pF
R6120	J02225102	Carbon Film RES.	1/6W	1k ohm	UJ	C6075	K12171102	Ceramic CAP.	E	50WV	0.001uF
R6121	J02225102	Carbon Film RES.	1/6W	1k ohm	UJ	C6076	K00173100	Ceramic CAP.	SL	50WV	10pF
R6122	J24205561	RES. Chip	1/10W	560 ohm		C6077	K00173100	Ceramic CAP.	SL	50WV	10pF
R6123	J02225101	Carbon Film RES.	1/6W	100 ohm	UJ	C6078	K12171102	Ceramic CAP.	E	50WV	0.001uF
R6125	J24205104	RES. Chip	1/10W	100k ohm		C6079	K70147105	Tantalum CAP.		25WV	1uF
5126	J02225471	Carbon Film RES.	1/6W	470 ohm	UJ	C6080	K13179008	Ceramic CAP.	F	50WV	0.01uF
VR6001	J51745102	POT.	B	1k ohm		C6081	K40109001	AL. Electro. CAP.		10WV	100uF
VR6002	J51745473	POT.	B	47k ohm		C6082	K70147105	Tantalum CAP.		25WV	1uF
VR6003	J51745473	POT.	B	47k ohm		C6084	K19149021	Ceramic CAP.		25WV	0.047uF
VR6004	J51745104	POT.	B	100k ohm		C6085	K19149021	Ceramic CAP.		25WV	0.047uF
C6001	K05173100	Ceramic CAP.	RH	50WV	10pF	C6086	K12171102	Ceramic CAP.	E	50WV	0.001uF
C6002	K05172050	Ceramic CAP.	RH	50WV	5pF	C6087	K13179008	Ceramic CAP.	F	50WV	0.01uF
C6003	K13179008	Ceramic CAP.	F	50WV	0.01uF	C6088	K13179008	Ceramic CAP.	F	50WV	0.01uF
C6004	K13179008	Ceramic CAP.	F	50WV	0.01uF	C6089	K00175470	Ceramic CAP.	SL	50WV	47pF
C6005	K13179008	Ceramic CAP.	F	50WV	0.01uF	C6090	K00175220	Ceramic CAP.	SL	50WV	22pF
C6006	K13179008	Ceramic CAP.	F	50WV	0.01uF	C6091	K13179008	Ceramic CAP.	F	50WV	0.01uF
C6007	K00172040	Ceramic CAP.	SL	50WV	4pF	C6092	K13179008	Ceramic CAP.	F	50WV	0.01uF
C6008	K12171102	Ceramic CAP.	E	50WV	0.001uF	C6093	K12171102	Ceramic CAP.	E	50WV	0.001uF
C6009	K13179014	Ceramic CAP.	F	50WV	0.0047uF	C6094	K70167104	Tantalum CAP.		35WV	0.1uF
C6010	K12171102	Ceramic CAP.	E	50WV	0.001uF	C6095	K40109002	AL. Electro. CAP.		10WV	47uF
C6011	K12171102	Ceramic CAP.	E	50WV	0.001uF	C6096	K13179008	Ceramic CAP.	F	50WV	0.01uF
C6012	K13179014	Ceramic CAP.	F	50WV	0.0047uF	C6097	K40109001	AL. Electro. CAP.		10WV	100uF
C6014	K00175330	Ceramic CAP.	SL	50WV	33pF	C6098	K12171102	Ceramic CAP.	E	50WV	0.001uF
C6015	K10179024	Ceramic CAP.	B	50WV	0.01uF	C6099	K12171102	Ceramic CAP.	E	50WV	0.001uF
C6016	K13179008	Ceramic CAP.	F	50WV	0.01uF	C6100	K12171102	Ceramic CAP.	E	50WV	0.001uF
C6017	K13179008	Ceramic CAP.	F	50WV	0.01uF	C6101	K19149021	Ceramic CAP.	E	25WV	0.047uF
C6018	K13179008	Ceramic CAP.	F	50WV	0.01uF	C6102	K12171102	Ceramic CAP.	E	50WV	0.001uF
C6019	K13179014	Ceramic CAP.	F	50WV	0.0047uF	C6103	K70167474	Tantalum CAP.		35WV	0.47uF
C6020	K13179014	Ceramic CAP.	F	50WV	0.0047uF	C6104	K19149021	Ceramic CAP.	E	25WV	0.047uF
C6021	K13179008	Ceramic CAP.	F	50WV	0.01uF	C6121	K12171102	Ceramic CAP.	E	50WV	0.001uF
C6022	K00173100	Ceramic CAP.	SL	50WV	10pF	C6122	K13179014	Ceramic CAP.	F	50WV	0.0047uF
C6023	K00173100	Ceramic CAP.	SL	50WV	10pF	C6123	K19149025	Ceramic CAP.		25WV	0.1uF
C6024	K13179008	Ceramic CAP.	F	50WV	0.01uF	C5124	K12171102	Ceramic CAP.	E	50WV	0.001uF
J25	K13179008	Ceramic CAP.	F	50WV	0.01uF	C6125	K19149021	Ceramic CAP.		25WV	0.047uF
J26	K05175150	Ceramic CAP.	RH	50WV	15pF	C6126	K40109001	AL. Electro. CAP.		10WV	100uF
C6027	K05175150	Ceramic CAP.	RH	50WV	15pF	C6127	K70167154	Tantalum CAP.		35WV	0.15uF
C6028	K05172020	Ceramic CAP.	RK	50WV	2pF	C6128	K19149021	Ceramic CAP.		25WV	0.047uF
C6029	K13179008	Ceramic CAP.	F	50WV	0.01uF	C6129	K12171102	Ceramic CAP.	E	50WV	0.001uF
C6030	K00175120	Ceramic CAP.	SL	50WV	12pF	C6130	K05173080	Ceramic CAP.	RH	50WV	8pF
C6031	K05173080	Ceramic CAP.	RH	50WV	8pF	C6131	K02175101	Ceramic CAP.	CH	50WV	100pF
C6032	K05172020	Ceramic CAP.	RK	50WV	2pF	C6132	K05175470	Ceramic CAP.	RH	50WV	47pF
C6033	K02172059	Ceramic CAP.	CK	50WV	0.5pF	C6133	K13179008	Ceramic CAP.	F	50WV	0.01uF
C6034	K05173080	Ceramic CAP.	RH	50WV	8pF	C6134	K12171102	Ceramic CAP.	E	50WV	0.001uF
C6035	K05172020	Ceramic CAP.	RK	50WV	2pF	C6135	K02179001	Ceramic CAP.	CK	50WV	1pF
C6036	K00175120	Ceramic CAP.	SL	50WV	12pF	C6136	K00175101	Ceramic CAP.	SL	50WV	100pF
C6037	K05173080	Ceramic CAP.	RH	50WV	8pF	C6137	K13179008	Ceramic CAP.	F	50WV	0.01uF
C6038	K02179001	Ceramic CAP.	CK	50WV	1pF	C6138	K13179008	Ceramic CAP.	F	50WV	0.01uF
C6039	K00173070	Ceramic CAP.	SL	50WV	7pF	C6139	K05173090	Ceramic CAP.	RH	50WV	9pF
C6040	K13179014	Ceramic CAP.	F	50WV	0.0047uF	C6140	K40129004	AL. Electro. CAP.		16WV	10uF
C6041	K12171102	Ceramic CAP.	E	50WV	0.001uF	C6141	K00173100	Ceramic CAP.	SL	50WV	10pF
C6042	K12171102	Ceramic CAP.	E	50WV	0.001uF	C6142	K05173090	Ceramic CAP.	RH	50WV	9pF
C6043	K40129004	AL. Electro. CAP.		16WV	10uF	C6143	K02172059	Ceramic CAP.	CK	50WV	0.5pF
C6044	K12171102	Ceramic CAP.	E	50WV	0.001uF	C6144	K05173090	Ceramic CAP.	RH	50WV	9pF
C6045	K13179014	Ceramic CAP.	F	50WV	0.0047uF	C6145	K00175220	Ceramic CAP.	SL	50WV	22pF
C6046	K00175180	Ceramic CAP.	SL	50WV	18pF	C6146	K13179008	Ceramic CAP.	F	50WV	0.01uF
C6047	K13179014	Ceramic CAP.	F	50WV	0.0047uF	C6147	K05173090	Ceramic CAP.	RH	50WV	9pF
C6048	K40129004	AL. Electro. CAP.		16WV	10uF						
C6049	K02172040	Ceramic CAP.	CH	50WV	4pF						
C6050	K13179008	Ceramic CAP.	F	50WV	0.01uF						

PARTS LIST

144MHz SUB VCO UNIT				430MHz RF UNIT			
Symbol No.	Part No.	Description	Device	Symbol No.	Part No.	Description	Device
	F2927000	Printed Circuit Board		C6506	K13179008	Ceramic CAP.	F 50WV 0.01uF
	C029270AA	PCB with Components		C6507	K40129004	AL. Electro. CAP.	16WV 10uF
Q6024	G3805070F	FET	2SK507F	C6508	K10176102	Ceramic CAP.	B 50WV 0.001uF
Q6025	G3333550	Transistor	2SC3355	C6509	K13179008	Ceramic CAP.	F 50WV 0.01uF
D6015	G2090180	Diode	FC53M-5	C6510	K40129004	AL. Electro. CAP.	16WV 10uF
D6016	G2090180	Diode	FC53M-5	C6511	K02175180	Ceramic CAP.	CH 50WV 18pF
R6078	J02225560	Carbon Film RES.	1/6W 56 ohm UJ	C6513	K02175330	Ceramic CAP.	CH 50WV 33pF
R6079	J02225330	Carbon Film RES.	1/6W 33 ohm UJ	C6514	K02179001	Ceramic CAP.	CK 50WV 1pF
R6080	J02225331	Carbon Film RES.	1/6W 330 ohm UJ	C6515(25W)	K02172040	Ceramic CAP.	CH 50WV 4pF
R6081	J02225332	Carbon Film RES.	1/6W 3.3k ohm UJ	C6516	K02175180	Ceramic CAP.	CH 50WV 8pF
R6082	J02225103	Carbon Film RES.	1/6W 10k ohm UJ	C6517	K02179001	Ceramic CAP.	CK 50WV 1pF
R6083	J02225101	Carbon Film RES.	1/6W 100 ohm UJ	C6518	K02175180	Ceramic CAP.	CH 50WV 18pF
R6084	J02225101	Carbon Film RES.	1/6W 100 ohm UJ	C6519	K02175180	Ceramic CAP.	CH 50WV 18pF
R6087	J02225560	Carbon Film RES.	1/6W 56 ohm UJ	C6520	K02175180	Ceramic CAP.	CH 50WV 18pF
C6105	K13179014	Ceramic CAP.	F 50WV 0.0047uF	C6521	K02175180	Ceramic CAP.	CH 50WV 18pF
C6106	K00173070	Ceramic CAP.	SL 50WV 7pF	C6522	K02175180	Ceramic CAP.	CH 50WV 18pF
C6107	K02172020	Ceramic CAP.	CK 50WV 2pF	C6523(10W)	K02173060	Ceramic CAP.	CH 50WV 6pF
C6108	K19149021	Ceramic CAP.	25WV 0.047uF	C6523(25W)	K02173100	Ceramic CAP.	CH 50WV 10pF
C6109	K12171102	Ceramic CAP.	E 50WV 0.001uF	C6524(10W)	K02173060	Ceramic CAP.	CH 50WV 6pF
C6110	K05175180	Ceramic CAP.	RH 50WV 18pF	C6524(25W)	K02173100	Ceramic CAP.	CH 50WV 10pF
C6111	K12171102	Ceramic CAP.	E 50WV 0.001uF	C6527	K02175150	Ceramic CAP.	CH 50WV 15pF
C6112	K40109001	AL. Electro. CAP.	10WV 100uF	C6528	K10176102	Ceramic CAP.	B 50WV 0.001uF
C6113	K06173080	Ceramic CAP.	RH 50WV 8pF	C6529	K10176102	Ceramic CAP.	B 50WV 0.001uF
C6114	K05173080	Ceramic CAP.	RH 50WV 8pF	C6530	K10176102	Ceramic CAP.	B 50WV 0.001uF
C6115	K02172059	Ceramic CAP.	CK 50WV 0.5pF	C6531	K10176102	Ceramic CAP.	B 50WV 0.001uF
C6117	K12171102	Ceramic CAP.	E 50WV 0.001uF	C6532	K10176102	Ceramic CAP.	B 50WV 0.001uF
C6118	K02172020	Ceramic CAP.	CK 50WV 2pF	C6533	K02173060	Ceramic CAP.	CH 50WV 6pF
C6119	K00173070	Ceramic CAP.	SL 50WV 7pF	L6501	L1020469	RFC	
C6120	K12171102	Ceramic CAP.	E 50WV 0.001uF	L6502	L1020469	RFC	
C6171	K13179014	Ceramic CAP.	F 50WV 0.0047uF	L6503	L1020663	RFC	
L6016	L1190258	M.RFC	10uH	L6504	L0021149	Coil	
L6017	L1190242	M.RFC	0.47uH	L6505	L0021149	Coil	
L6018	L1190242	M.RFC	0.47uH	L6506	L0021457	Coil	
L6019	L0190138	Coil		L6508	L0021149	Coil	
L6020	L0021520	Coil		L6509	L0021149	Coil	
L6021	L1190242	M.RFC	0.47uH	L6510	L1190095	M.RFC	4.7uH
L6028	L0020852	Coil		L6511	L1190254	M.RFC	4.7uH
L6029	L0021359	Coil		L6512	L0020749	Coil	
L6030	L0021359	Coil		Q5000057	TP-G		MK-1095
FB6003	L9190001	Ferrite Beads		R6047250	Booster Spacer		
FB6004	L9190001	Ferrite Beads					
	R0062770B	VCO Case A					
144MHz PA UNIT							
Symbol No.	Part No.	Description	Device				
	F2887104	Printed Circuit Board					
	C028874AA	PCB with Components: 10W Model					
	C028874AB	PCB with Components: 25W Model					
Q6501(10W)	G1090295	IC	M57713				
Q6501(25W)	G1090474	IC	M57727				
D6501	G2090337	Diode	MI308				
D6502	G2090344	Diode	1SV178				
D6503	G2090344	Diode	1SV178				
D6504	G2090118	Diode	1SS97				
D6505	G2090118	Diode	1SS97				
R6501	J31309002	RES.	1W 0.1 ohm				
R6502(25W)	J31309002	RES.	1W 0.1 ohm				
R6503	J01275151	Carbon Film RES.	1/2W 150 ohm TJ				
R6504	J02245103	Carbon Film RES.	1/4W 10k ohm SJ				
R6505	J02245103	Carbon Film RES.	1/4W 10k ohm SJ				
C6502	K10176102	Ceramic CAP.	B 50WV 0.001uF	Q7003	G3333550	Transistor	2SC3355
C6503	K13179008	Ceramic CAP.	F 50WV 0.01uF	Q7004	G3333550	Transistor	2SC3355
C6504	K40129004	AL. Electro. CAP.	16WV 10uF	Q7007	G3333550	Transistor	2SC3355
C6505	K10176102	Ceramic CAP.	B 50WV 0.001uF	Q7008	G1090804	IC	uPC1656C
				Q7010	G3304600B	Transistor	2SC460B
				Q7011	G3304580C	Transistor	2SC458C
				Q7012	G3802410G	FET	2SK241GR
				Q7013	G3802410G	FET	2SK241GR
				Q7014	G4801220L	FET	3SK122L
				Q7015	G2090135	Diode	ND487C2-3R
				Q7016	G1090804	IC	uPC1656C
				Q7017	G3333550	Transistor	2SC3355
				Q7018	G3090050	Transistor	2SC2407(1)
				Q7022	G4801220L	FET	3SK122L
				Q7023	G4800810	FET	3SK81
				Q7024	G3090079	Transistor	BA1A4P
				Q7025	G3090079	Transistor	BA1A4P
				Q7026	G3207720Q	Transistor	2SB772Q
				Q7027	G3207720Q	Transistor	2SB772Q

PARTS LIST

Q7028	G3115280	Transistor	2SA1528	R7075	J02225101	Carbon Film RES.	1/6W	100 ohm	UJ
Q7029	G3115280	Transistor	2SA1528	R7076	J02225471	Carbon Film RES.	1/6W	470 ohm	UJ
Q7030	G3090079	Transistor	BA1A4P	R7077	J02225101	Carbon Film RES.	1/6W	100 ohm	UJ
Q7031	G3304580C	Transistor	2SC458C	R7091	J01225225	Carbon Film RES.	1/6W	2.2M ohm	PJ
Q7032	G3304580C	Transistor	2SC458C	R7092	J01225473	Carbon Film RES.	1/6W	47k ohm	PJ
Q7033	G3802410G	FET	2SK241GR	R7093	J01225470	Carbon Film RES.	1/6W	47 ohm	PJ
Q7034	G3090079	Transistor	BA1A4P	R7094	J01225102	Carbon Film RES.	1/6W	1k ohm	PJ
				R7095	J01225560	Carbon Film RES.	1/6W	56 ohm	PJ
D7003	G2090408	Diode	1SS270	R7096	J02225473	Carbon Film RES.	1/6W	47k ohm	UJ
D7004	G2090027	Diode	1SS53	R7097	J01225473	Carbon Film RES.	1/6W	47k ohm	PJ
D7005	G2090027	Diode	1SS53	R7098	J01225271	Carbon Film RES.	1/6W	270 ohm	PJ
D7006	G2060004	Diode	1SS270TJ	R7099	J01225560	Carbon Film RES.	1/6W	56 ohm	PJ
D7007	G2090027	Diode	1SS53	R7100	J01225560	Carbon Film RES.	1/6W	56 ohm	PJ
D7008	G2015550	Diode	1S1555	R7101	J02225680	Carbon Film RES.	1/6W	68 ohm	UJ
D7009	G2015550	Diode	1S1555	R7102	J01225681	Carbon Film RES.	1/6W	680 ohm	PJ
D7010	G2090027	Diode	1SS53	R7103	J01225560	Carbon Film RES.	1/6W	56 ohm	PJ
D7011	G2060004	Diode	1SS270TJ	R7104	J02225331	Carbon Film RES.	1/6W	330 ohm	UJ
D7012	G2090027	Diode	1SS53	R7106	J02225104	Carbon Film RES.	1/6W	100k ohm	UJ
D7013	G2090027	Diode	1SS53	R7107	J02225471	Carbon Film RES.	1/6W	470 ohm	UJ
D7014	G2090408	Diode	1SS270	R7108	J02225221	Carbon Film RES.	1/6W	220 ohm	UJ
D7015	G2090408	Diode	1SS270	R7109	J02225560	Carbon Film RES.	1/6W	56 ohm	UJ
D7016	G2090408	Diode	1SS270	R7110	J24205680	RES. Chip	1/10W	68 ohm	
D7017	G2090408	Diode	1SS270	R7111	J01225472	Carbon Film RES.	1/6W	4.7k ohm	PJ
D7018	G2090408	Diode	1SS270	R7112	J01225102	Carbon Film RES.	1/6W	1k ohm	PJ
D7019	G2060004	Diode	1SS270TJ	R7113	J24205101	RES. Chip	1/10W	100 ohm	
TH7001	G9090026	Thermistor		VR7001	J51745101	POT.	B	100 ohm	
TH7002	G9090026	Thermistor		VR7002	J51745102	POT.	B	1k ohm	
TH7003	G9090026	Thermistor		VR7003	J51745101	POT.	B	100 ohm	
				VR7004	J51745473	POT.	B	47k ohm	
				VR7005	J51745473	POT.	B	47k ohm	
				VR7006	J51745104	POT.	B	100k ohm	
XF7001	H1102127	XTAL Filter	47L20A1						
R7008	J02225181	Carbon Film RES.	1/6W 180 ohm	UJ					
R7009	J02225330	Carbon Film RES.	1/6W 33 ohm	UJ	C7010	K12171102	Ceramic CAP.	E	50WV 0.001uF
R7010	J01225181	Carbon Film RES.	1/6W 180 ohm	PJ	C7011	K12171102	Ceramic CAP.	E	50WV 0.001uF
R7011	J02225101	Carbon Film RES.	1/6W 100 ohm	UJ	C7012	K12171102	Ceramic CAP.	E	50WV 0.001uF
R7012	J02225680	Carbon Film RES.	1/6W 68 ohm	UJ	C7013	K12171102	Ceramic CAP.	E	50WV 0.001uF
R7013	J02225101	Carbon Film RES.	1/6W 100 ohm	UJ	C7014	K12171102	Ceramic CAP.	E	50WV 0.001uF
R7014	J02225222	Carbon Film RES.	1/6W 2.2k ohm	UJ	C7015	K19149025	Ceramic CAP.		25WV 0.1uF
R7015	J01225222	Carbon Film RES.	1/6W 2.2k ohm	PJ	C7016	K13179008	Ceramic CAP.	F	50WV 0.01uF
R7016	J01225101	Carbon Film RES.	1/6W 100 ohm	PJ	C7017	K13179008	Ceramic CAP.	F	50WV 0.01uF
R7017	J01225101	Carbon Film RES.	1/6W 100 ohm	PJ	C7018	K13179008	Ceramic CAP.	F	50WV 0.01uF
R7018	J01225682	Carbon Film RES.	1/6W 6.8k ohm	PJ	C7019	K05175150	Ceramic CAP.	RH	50WV 15pF
R7019	J01225223	Carbon Film RES.	1/6W 22k ohm	PJ	C7020	K02172050	Ceramic CAP.	CH	50WV 5pF
R7025	J02225221	Carbon Film RES.	1/6W 220 ohm	UJ	C7024	K13179014	Ceramic CAP.	F	50WV 0.0047uF
R7026	J02225223	Carbon Film RES.	1/6W 22k ohm	UJ	C7025	K40129004	AL. Electro. CAP.		16WV 10uF
R7027	J02225682	Carbon Film RES.	1/6W 6.8k ohm	UJ					
R7028	J02225101	Carbon Film RES.	1/6W 100 ohm	UJ	C7031	K13179014	Ceramic CAP.	F	50WV 0.0047uF
R7029	J02225103	Carbon Film RES.	1/6W 10k ohm	UJ	C7032	K13179014	Ceramic CAP.	F	50WV 0.0047uF
R7030	J01225223	Carbon Film RES.	1/6W 22k ohm	PJ	C7033	K00175470	Ceramic CAP.	SL	50WV 47pF
R7031	J02225103	Carbon Film RES.	1/6W 10k ohm	UJ	C7034	K00175101	Ceramic CAP.	SL	50WV 100pF
R7032	J02225103	Carbon Film RES.	1/6W 10k ohm	UJ	C7035	K12171102	Ceramic CAP.	E	50WV 0.001uF
R7033	J02245471	Carbon Film RES.	1/4W 470 ohm	SJ	C7036	K12171102	Ceramic CAP.	E	50WV 0.001uF
R7034	J02245471	Carbon Film RES.	1/2W 470 ohm	TJ	C7037	K40109002	AL. Electro. CAP.		10WV 47uF
R7037	J02225331	Carbon Film RES.	1/6W 330 ohm	UJ					
R7039	J02225150	Carbon Film RES.	1/6W 15 ohm	UJ	C7038	K22170805	CAP. Chip.	B	50WV 0.001uF
R7040	J02225391	Carbon Film RES.	1/6W 390 ohm	UJ	C7040	K22170805	CAP. Chip.	B	50WV 0.001uF
R7041	J02225332	Carbon Film RES.	1/6W 3.3k ohm	UJ	C7041	K40129004	AL. Electro. CAP.		16WV 10uF
R7042	J02225103	Carbon Film RES.	1/6W 10k ohm	UJ					
R7043	J02225101	Carbon Film RES.	1/6W 100 ohm	UJ	C7042	K12171102	Ceramic CAP.	E	50WV 0.001uF
R7044	J02225560	Carbon Film RES.	1/6W 56 ohm	UJ	C7043	K40129004	AL. Electro. CAP.		16WV 10uF
R7045	J01225332	Carbon Film RES.	1/6W 3.3k ohm	PJ					
R7046	J02225103	Carbon Film RES.	1/6W 10k ohm	UJ	C7047	K02179001	Ceramic CAP.	CK	50WV 1pF
R7047	J02225331	Carbon Film RES.	1/6W 330 ohm	UJ	C7048	K12171102	Ceramic CAP.	E	50WV 0.001uF
R7048	J01225102	Carbon Film RES.	1/6W 1k ohm	PJ	C7049	K12171102	Ceramic CAP.	E	50WV 0.001uF
R7049	J02225221	Carbon Film RES.	1/6W 220 ohm	UJ	C7050	K05172020	Ceramic CAP.	RK	50WV 2pF
R7050	J02225221	Carbon Film RES.	1/6W 220 ohm	UJ	C7051	K12171102	Ceramic CAP.	E	50WV 0.001uF
R7051	J01225473	Carbon Film RES.	1/6W 47k ohm	PJ	C7052	K12171102	Ceramic CAP.	E	50WV 0.001uF
R7052	J02225331	Carbon Film RES.	1/6W 330 ohm	UJ	C7053	K13179010	Ceramic CAP.	F	50WV 0.022uF
R7053	J02225473	Carbon Film RES.	1/6W 47k ohm	UJ	C7055	K13179008	Ceramic CAP.	F	50WV 0.01uF
R7054	J02225152	Carbon Film RES.	1/6W 1.5k ohm	UJ	C7056	K00173080	Ceramic CAP.	SL	50WV 8pF
R7055	J02225102	Carbon Film RES.	1/6W 1k ohm	UJ	C7057	K00175220	Ceramic CAP.	SL	50WV 22pF
R7056	J02225102	Carbon Film RES.	1/6W 1k ohm	UJ	C7058	K05175220	Ceramic CAP.	RH	50WV 22pF
R7060	J01225101	Carbon Film RES.	1/6W 100 ohm	PJ	C7060	K00175470	Ceramic CAP.	SL	50WV 47pF
R7061	J01225681	Carbon Film RES.	1/6W 680 ohm	PJ	C7061	K13179014	Ceramic CAP.	F	50WV 0.0047uF
R7062	J01225473	Carbon Film RES.	1/6W 47k ohm	PJ	C7062	K40109001	AL. Electro. CAP.		10WV 100uF
R7063	J01225473	Carbon Film RES.	1/6W 47k ohm	PJ					
R7064	J01225560	Carbon Film RES.	1/6W 56 ohm	PJ	C7063	K00173100	Ceramic CAP.	SL	50WV 10pF
R7065	J02225473	Carbon Film RES.	1/6W 47k ohm	UJ	C7064	K00175220	Ceramic CAP.	SL	50WV 22pF
R7066	J02225333	Carbon Film RES.	1/6W 33k ohm	UJ	C7065	K00175121	Ceramic CAP.	SL	50WV 120pF
R7067	J01225101	Carbon Film RES.	1/6W 100 ohm	PJ	C7066	K12171102	Ceramic CAP.	E	50WV 0.001uF
R7068	J01225473	Carbon Film RES.	1/6W 47k ohm	PJ	C7067	K40179013	AL. Electro. CAP.		50WV 1uF
R7069	J02225331	Carbon Film RES.	1/6W 330 ohm	UJ					
R7070	J02225180	Carbon Film RES.	1/6W 18 ohm	UJ	C7068	K70147105	Tantalum CAP.		25WV 1uF
R7071	J02225331	Carbon Film RES.	1/6W 330 ohm	UJ	C7069	K19149021	Ceramic CAP.		25WV 0.047uF
R7072	J01225479	Carbon Film RES.	1/6W 4.7 ohm	PJ	C7070	K12171102	Ceramic CAP.	E	50WV 0.001uF
R7074	J01225331	Carbon Film RES.	1/6W 330 ohm	PJ	C7071	K00173070	Ceramic CAP.	SL	50WV 7pF

PARTS LIST

L7401	L1190242	M.RFC	0.47uH	C7706	K22170319	CAP. Chip	UJ	50WV	22pF
L7402	L1190242	M.RFC	0.47uH	C7707	K22170805	CAP. Chip	B	50WV	0.001uF
L7403	F2896000			C7708	K40109015	AL. Electro. CAP.		10WV	100uF
L7404	L0021520	Coil		C7709	K22170813	CAP. Chip	B	50WV	0.0047uF
L7405	L1190242	M.RFC	0.47uH	C7710	K22170202	CAP. Chip	CH	50WV	1pF
FB7401	L9190001	Ferrite Beads		C7711	K22171004	CAP. Chip	F	50WV	0.01uF
FB7402	L9190001	Ferrite Beads		C7712	K40109015	AL. Electro. CAP.		10WV	100uF
TP7401	Q5000036	TP-G	MK-1095	C7713	K22170813	CAP. Chip	B	50WV	0.0047uF
TP7402	Q5000036	TP-G	MK-1095	C7714	K22170813	CAP. Chip	B	50WV	0.0047uF
TP7403	Q5000036	TP-G	MK-1095	C7715	K22171004	CAP. Chip	F	50WV	0.01uF
	R0062770B	VCO Case A		C7716	K22141809	CAP. Chip	B	25WV	0.1uF
	R0062780A	VCO Case Lid		C7717	K22170813	CAP. Chip	B	50WV	0.0047uF
	R0121190	PCB Holder		C7718	K22170813	CAP. Chip	B	50WV	0.0047uF
				C7719	K22170805	CAP. Chip	B	50WV	0.001uF
				C7720	K22171004	CAP. Chip	F	50WV	0.01uF
				C7721	K78120009	Tantalum CAP. Chip		16WV	1uF
430MHz ALC UNIT				C7722	K78140009	Tantalum CAP. Chip		25WV	0.47uF
Symbol No.	Part No.	Description	Device						
	F2892105A	Printed Circuit Board							
	C028925AA	PCB with Components		C7724	K22141809	CAP. Chip	B	25WV	0.1uF
Q9601	G1090564	IC	uPC358G	TC7701	K91000114	Variable CAP.		6pF	
D9601	G2070001	Diode	1SS181 TE85R	T7701	L0021358	Coil			
D9602	G2070001	Diode	1SS181 TE85R	L7702	L1190348	M.RFC			
R9601	J24205223	RES. Chip	1/10W 22k ohm		Q5000057	Lead Frame			
R9602	J24205103	RES. Chip	1/10W 10k ohm	PLL IC UNIT					
R9603	J24205473	RES. Chip	1/10W 47k ohm	Symbol No.	Part No.	Description	Device		
R9604	J24205223	RES. Chip	1/10W 22k ohm		F2919102	Printed Circuit Board			
R9605	J24205000	RES. Chip	1/10W 0 ohm		C029192AA	PCB with Components			
R9606	J24205000	RES. Chip	1/10W 0 ohm	Q7601	G1090582	IC	JLC1007P		
R9607	J24205000	RES. Chip	1/10W 0 ohm	Q7602	G1090829	IC	MB503		
R9608	J24205104	RES. Chip	1/10W 100k ohm	D7601	G2090185	Diode	HZ5C2		
R9609	J24205223	RES. Chip	1/10W 22k ohm	R7601	J24205222	RES. Chip	1/10W 2.2k ohm		
R9610	J24205473	RES. Chip	1/10W 47k ohm	R7602	J24205103	RES. Chip	1/10W 10k ohm		
R9611	J24205473	RES. Chip	1/10W 47k ohm	R7603	J24205103	RES. Chip	1/10W 10k ohm		
C9601	K22170227	CAP. Chip	CH 50WV 47pF	R7604	J24205221	RES. Chip	1/10W 220 ohm		
C9603	K22170227	CAP. Chip	CH 50WV 47pF	C7601	K22171004	CAP. Chip	F 50WV 0.01uF		
C9604	K22170805	CAP. Chip	B 50WV 0.001uF	C7602	K22170813	CAP. Chip	B 50WV 0.0047uF		
C9605	K22170805	CAP. Chip	B 50WV 0.001uF	C7603	K22171004	CAP. Chip	F 50WV 0.01uF		
	Q5000057	Lead Frame		C7604	K40129012	AL. Electro. CAP.		16WV	10uF
430MHz LOCAL UNIT				C7605	K22171004	CAP. Chip	F 50WV 0.01uF		
Symbol No.	Part No.	Description	Device	C7606	K22141809	CAP. Chip	B 25WV 0.1uF		
	F2919101	Printed Circuit Board			Q5000057	Lead Frame			
	C029191AA	PCB with Components		430MHz PLL UNIT					
Q7701	G3802100G	FET	2SK210GR	Symbol No.	Part No.	Description	Device		
Q7702	G3803020G	FET	2SK302GR		F2888103A	Printed Circuit Board			
Q7703	G1090829	IC	MB503		C028883AA	PCB with Components: Vers. A1,A2 w/o 430MHz SHIFT UNIT,			
Q7704	G1090739	IC	MC145163SL		C028883AB	PCB with Components: Vers. B1,B2,B3 w/o 430MHz SHIFT UNIT,			
Q7705	G3327120G	Transistor	2SC2712GR		C028883AC	PCB with Components: Vers. C1,C2,C3 w/o 430MHz SHIFT UNIT,			
D7701	G2090108	Diode	1SV68		C028883AD	PCB with Components: Vers. F w/o 430MHz SHIFT UNIT,			
D7702	G2090188	Diode	HZ5C1						
R7701	J24205474	RES. Chip	1/10W 470k ohm						
R7702	J24205221	RES. Chip	1/10W 220 ohm						
R7703	J24205101	RES. Chip	1/10W 100 ohm						
R7704	J24205471	RES. Chip	1/10W 470 ohm						
R7705	J24205471	RES. Chip	1/10W 470 ohm						
R7706	J24205221	RES. Chip	1/10W 220 ohm						
R7707	J24205222	RES. Chip	1/10W 2.2k ohm						
R7708	J24205471	RES. Chip	1/10W 470 ohm						
R7709	J24205473	RES. Chip	1/10W 47k ohm						
R7710	J24205221	RES. Chip	1/10W 220 ohm						
R7711	J24205222	RES. Chip	1/10W 2.2k ohm						
R7712	J24205000	RES. Chip	1/10W 0 ohm						
R7713	J24205101	RES. Chip	1/10W 100 ohm						
R7714	J01225104	Carbon Film RES.	1/6W 100k ohm						
C7701	K22170305	CAP. Chip	UJ 50WV 4pF						
C7702	K22170307	CAP. Chip	UJ 50WV 6pF						
C7703	K22170304	CAP. Chip	UJ 50WV 3pF						
C7704	K22170211	CAP. Chip	CH 50WV 10pF						
C7705	K22170309	CAP. Chip	UJ 50WV 8pF						

PARTS LIST

C028883AE	PCB with Components: Vers. H1, H2, H3 w/o 430MHz SHIFT UNIT.			R8027	J01225470	Carbon Film RES.	1/6W	47 ohm	PJ
				R8028	J02225560	Carbon Film RES.	1/6W	56 ohm	UJ
				R8030	J02225332	Carbon Film RES.	1/6W	3.3k ohm	UJ
				R8031	J02225222	Carbon Film RES.	1/6W	2.2k ohm	UJ
				R8032	J02225104	Carbon Film RES.	1/6W	100k ohm	UJ
				R8033	J01225472	Carbon Film RES.	1/6W	4.7k ohm	PJ
C028883AF	PCB with Components: Vers. A1, A2 w/ 430MHz SHIFT UNIT.			R8034	J02225223	Carbon Film RES.	1/6W	22k ohm	UJ
				R8035	J01225223	Carbon Film RES.	1/6W	22k ohm	PJ
				R8036	J02225681	Carbon Film RES.	1/6W	680 ohm	UJ
				R8037	J02225103	Carbon Film RES.	1/6W	10k ohm	UJ
				R8038	J02225272	Carbon Film RES.	1/6W	2.7k ohm	UJ
C028883AG	PCB with Components: Vers. B1, B2, B3 w/ 430MHz SHIFT UNIT.			R8039	J02225470	Carbon Film RES.	1/6W	47 ohm	UJ
				R8040	J01225150	Carbon Film RES.	1/6W	15 ohm	PJ
				R8041	J01225820	Carbon Film RES.	1/6W	82 ohm	PJ
				R8042	J01225680	Carbon Film RES.	1/6W	68 ohm	PJ
				R8043	J01225820	Carbon Film RES.	1/6W	82 ohm	PJ
				R8044	J02225101	Carbon Film RES.	1/6W	100 ohm	UJ
				R8045	J02225331	Carbon Film RES.	1/6W	330 ohm	UJ
				R8046	J02225682	Carbon Film RES.	1/6W	6.8k ohm	UJ
				R8047	J02225223	Carbon Film RES.	1/6W	22k ohm	UJ
				R8048	J02225150	Carbon Film RES.	1/6W	15 ohm	UJ
				R8049	J02225101	Carbon Film RES.	1/6W	100 ohm	UJ
				R8050	J02225102	Carbon Film RES.	1/6W	1k ohm	UJ
				C8001	K70167474	Tantalum CAP.		35WV	0.47uF
				C8002	K19149021	Ceramic CAP.		25WV	0.047uF
				C8003	K12171102	Ceramic CAP.	E	50WV	0.001uF
				C8004	K05175150	Ceramic CAP.	RH	50WV	15pF
				C8005	K12171102	Ceramic CAP.	E	50WV	0.001uF
				C8006	K40109001	AL. Electro. CAP.		10WV	100uF
				C8007	K02175120	Ceramic CAP.	CH	50WV	12pF
				C8008	K05173080	Ceramic CAP.	RH	50WV	8pF
				C8009	K02172059	Ceramic CAP.	CK	50WV	0.5pF
				C8010	K13179014	Ceramic CAP.	F	50WV	0.0047uF
				C8011	K13179014	Ceramic CAP.	F	50WV	0.0047uF
				C8012	K00172020	Ceramic CAP.	SL	50WV	2pF
				C8013	K00173070	Ceramic CAP.	SL	50WV	7pF
				C8014	K12171102	Ceramic CAP.	E	50WV	0.001uF
				C8015	K13179014	Ceramic CAP.	F	50WV	0.0047uF
				C8016	K19149025	Ceramic CAP.		25WV	0.1uF
				C8017	K12171102	Ceramic CAP.	E	50WV	0.001uF
				C8018	K12171102	Ceramic CAP.	E	50WV	0.001uF
				C8019	K40109002	AL. Electro. CAP.		10WV	47uF
				C8020	K19149025	Ceramic CAP.		25WV	0.1uF
				C8021	K13179008	Ceramic CAP.	F	50WV	0.01uF
				C8022	K00175220	Ceramic CAP.	SL	50WV	22pF
				C8023	K00175220	Ceramic CAP.	SL	50WV	22pF
				C8024	K13179008	Ceramic CAP.	F	50WV	0.01uF
				C8025	K00172020	Ceramic CAP.	SL	50WV	2pF
				C8026	K00173070	Ceramic CAP.	SL	50WV	7pF
				C8027	K12171102	Ceramic CAP.	E	50WV	0.001uF
				C8028	K19149025	Ceramic CAP.		25WV	0.1uF
				C8029	K13179014	Ceramic CAP.	F	50WV	0.0047uF
				C8030	K12171102	Ceramic CAP.	E	50WV	0.001uF
				C8031	K12171102	Ceramic CAP.	E	50WV	0.001uF
				C8032	K19149025	Ceramic CAP.		25WV	0.1uF
				C8033	K19149025	Ceramic CAP.		25WV	0.1uF
				C8034	K40109001	AL. Electro. CAP.		10WV	100uF
				C8035	K13179014	Ceramic CAP.	F	50WV	0.0047uF
				C8036	K13179014	Ceramic CAP.	F	50WV	0.0047uF
				C8037	K40129004	AL. Electro. CAP.		16WV	10uF
				C8038	K12171102	Ceramic CAP.	E	50WV	0.001uF
				C8039	K13179008	Ceramic CAP.	F	50WV	0.01uF
				C8040	K13179008	Ceramic CAP.	F	50WV	0.01uF
				C8041	K40179011	AL. Electro. CAP.		50WV	3.3uF
				C8042	K00173070	Ceramic CAP.	SL	50WV	7pF
				C8043	K13179008	Ceramic CAP.	F	50WV	0.01uF
				C8044	K00172020	Ceramic CAP.	SL	50WV	2pF
				C8045	K13179008	Ceramic CAP.	F	50WV	0.01uF
				C8046	K00175470	Ceramic CAP.	SL	50WV	47pF
				C8047	K13179014	Ceramic CAP.	F	50WV	0.0047uF
				C8048	K00175220	Ceramic CAP.	SL	50WV	2pF
				C8049	K19149015	Ceramic CAP.		25WV	0.015uF
				C8050	K05172030	Ceramic CAP.	RJ	50WV	3pF
				C8051	K05175470	Ceramic CAP.	RH	50WV	47pF
				C8052	K05175560	Ceramic CAP.	RH	50WV	56pF
				C8053	K13179008	Ceramic CAP.	F	50WV	0.01uF
				C8054	K05175150	Ceramic CAP.	RH	50WV	15pF
				C8055	K05175470	Ceramic CAP.	RH	50WV	47pF
				C8056	K22171004	CAP. Chip	F	50WV	0.01uF
				C8057	K13179014	Ceramic CAP.	F	50WV	0.0047uF
				C8058	K05172030	Ceramic CAP.	RJ	50WV	3pF
Q8001	G3805070F	FET	2SK705F						
Q8002	G3333550	Transistor	2SC3355						
Q8003	G1090795	IC	MB504						
Q8004	G1090707	IC	MC145156P						
Q8005	G1090796	IC	MB505-16						
Q8006	G1090247	IC	TC9122P						
Q8007	G3304580C	Transistor	2SC458C						
Q8008	G1090473	IC	TC5081AP						
Q8009	G3305350B	Transistor	2SC535B						
Q8010	G3802410G	FET	2SK241GR						
Q8011	G3304580C	Transistor	2SC458C						
Q8012	G3305350B	Transistor	2SC535B						
Q8013	G3324071	Transistor	2SC2407A						
Q8014	G3305350B	Transistor	2SC535B						
Q8015	G1090084	IC	uPC78L05						
D8001	G2090180	Diode	FC53M-5						
D8002	G2090180	Diode	FC53M-5						
D8003	G2090180	Diode	FC53M-5						
D8004		See Model Chart							
D8005		See Model Chart							
D8006		See Model Chart							
D8007		See Model Chart							
D8008		See Model Chart							
D8010		See Model Chart							
D8011		See Model Chart							
D8012	G2090384	Diode	HZ7C2						
Y01	H0102818	XTAL	HC-49T 61.46833MHZ						
R8001	J01225561	Carbon Film RES.	1/6W 560 ohm	PJ					
R8002	J01225471	Carbon Film RES.	1/6W 470 ohm	PJ					
R8003	J01225102	Carbon Film RES.	1/6W 1k ohm	PJ					
R8004	J02225222	Carbon Film RES.	1/6W 2.2k ohm	UJ					
R8005	J01225330	Carbon Film RES.	1/6W 33 ohm	PJ					
R8006	J02225221	Carbon Film RES.	1/6W 220 ohm	UJ					
R8007	J02225332	Carbon Film RES.	1/6W 3.3k ohm	UJ					
R8008	J01225103	Carbon Film RES.	1/6W 10k ohm	PJ					
R8009	J02225101	Carbon Film RES.	1/6W 100 ohm	UJ					
R8010	J02225101	Carbon Film RES.	1/6W 100 ohm	UJ					
R8011	J02225560	Carbon Film RES.	1/6W 56 ohm	UJ					
R8012	J01225222	Carbon Film RES.	1/6W 2.2k ohm	PJ					
R8013	J02225560	Carbon Film RES.	1/6W 56 ohm	UJ					
R8014	J02225222	Carbon Film RES.	1/6W 2.2k ohm	UJ					
R8015	J02225104	Carbon Film RES.	1/6W 100k ohm	UJ					
R8016	J02225471	Carbon Film RES.	1/6W 470 ohm	UJ					
R8017	J01225101	Carbon Film RES.	1/6W 100 ohm	PJ					
R8018	J01225560	Carbon Film RES.	1/6W 56 ohm	PJ					
R8019	J02225331	Carbon Film RES.	1/6W 330 ohm	UJ					
R8020	J02225682	Carbon Film RES.	1/6W 6.8k ohm	UJ					
R8021	J02225223	Carbon Film RES.	1/6W 22k ohm	UJ					
R8022	J02225560	Carbon Film RES.	1/6W 56 ohm	UJ					
R8023	J02225471	Carbon Film RES.	1/6W 470 ohm	UJ					
R8024	J02225471	Carbon Film RES.	1/6W 470 ohm	UJ					
R8025	J02225223	Carbon Film RES.	1/6W 22k ohm	UJ					
R8026	J02225682	Carbon Film RES.	1/6W 6.8k ohm	UJ					

PARTS LIST

X1001	H0102811	XTAL	HC-49/T 5.5296MHz		R1089	J01225333	Carbon Film RES.	1/6W 33k ohm	UJ
X1002	H0102549	XTAL	HC-49/U 3.6864MHz		R1091	J02225103	Carbon Film RES.	1/6W 10k ohm	UJ
X1003*	H0101982	XTAL	HC-18/T 7.168MHz		R1092	J02225105	Carbon Film RES.	1/6W 1M ohm	UJ
X1003°	H0101983	XTAL	HC-18/T 7.3728MHz		R1093	J02225223	Carbon Film RES.	1/6W 22k ohm	UJ
					R1094**	J02225104	Carbon Film RES.	1/6W 100k ohm	UJ
R1001	J01275479	Carbon Film RES.	1/2W 4.7 ohm	TJ					
R1002	J02225101	Carbon Film RES.	1/6W 100 ohm	UJ	C1001	K40129043	AL. Electro. CAP.	16WV 330uF	
R1003	J02225222	Carbon Film RES.	1/6W 2.2k ohm	UJ					
R1004	J02225101	Carbon Film RES.	1/6W 100 ohm	UJ	C1002	K40129043	AL. Electro. CAP.	16WV 330uF	
R1006	J02225222	Carbon Film RES.	1/6W 2.2k ohm	UJ					
R1007	J02225221	Carbon Film RES.	1/6W 220 ohm	UJ	C1003	K40129008	AL. Electro. CAP.	16WV 33uF	
R1008	J02225473	Carbon Film RES.	1/6W 47k ohm	UJ					
R1009	J02225472	Carbon Film RES.	1/6W 4.7k ohm	UJ	C1004	K40129043	AL. Electro. CAP.	16WV 330uF	
R1010	J02225472	Carbon Film RES.	1/6W 4.7k ohm	UJ					
R1011	J02225223	Carbon Film RES.	1/6W 22k ohm	UJ	C1005	K19149021	Ceramic CAP.	25WV 0.047uF	
R1012	J02225472	Carbon Film RES.	1/6W 4.7k ohm	UJ	C1006	K19149013	Ceramic CAP.	25WV 0.01uF	
R1013	J02225472	Carbon Film RES.	1/6W 4.7k ohm	UJ	C1007	K40179014	AL. Electro. CAP.	50WV 10uF	
R1014	J02225103	Carbon Film RES.	1/6W 10k ohm	UJ					
R1016	J02225472	Carbon Film RES.	1/6W 4.7k ohm	UJ	C1008	K13179008	Ceramic CAP.	F 50WV 0.01uF	
R1017	J40900163	Block RES.	1/8W 10k ohm	UJ	C1009	K40129004	AL. Electro. CAP.	16WV 10uF	
R1018	J02225472	Carbon Film RES.	1/6W 4.7k ohm	UJ					
R1019	J02225103	Carbon Film RES.	1/6W 10k ohm	UJ	C1010	K12171102	Ceramic CAP.	E 50WV 0.001uF	
R1020	J02225103	Carbon Film RES.	1/6W 10k ohm	UJ	C1011	K40129049	AL. Electro. CAP.	16WV 470uF	
R1021	J02225333	Carbon Film RES.	1/6W 33k ohm	UJ					
R1022	J02225333	Carbon Film RES.	1/6W 33k ohm	UJ	C1012	K40149001	AL. Electro. CAP.	25WV 4.7uF	
R1023	J02225333	Carbon Film RES.	1/6W 33k ohm	UJ					
R1024	J02225333	Carbon Film RES.	1/6W 33k ohm	UJ	C1013	K40109001	AL. Electro. CAP.	10WV 100uF	
R1025	J02225104	Carbon Film RES.	1/6W 100k ohm	UJ					
R1026	J02225104	Carbon Film RES.	1/6W 100k ohm	UJ	C1014	K19149021	Ceramic CAP.	25WV 0.047uF	
R1027	J02225104	Carbon Film RES.	1/6W 100k ohm	UJ	C1015	K70107475	Tantalum CAP.	10WV 4.7uF	
R1028	J02225104	Carbon Film RES.	1/6W 100k ohm	UJ	C1016	K12171102	Ceramic CAP.	E 50WV 0.001uF	
R1029	J02225334	Carbon Film RES.	1/6W 330k ohm	UJ	C1017	K40129004	AL. Electro. CAP.	16WV 10uF	
R1030	J02225334	Carbon Film RES.	1/6W 330k ohm	UJ					
R1031	J02225334	Carbon Film RES.	1/6W 330k ohm	UJ	C1018	K19149021	Ceramic CAP.	25WV 0.0047uF	
R1032	J02225334	Carbon Film RES.	1/6W 330k ohm	UJ	C1019	K00175150	Ceramic CAP.	SL 50WV 15pF	
R1033	J02225473	Carbon Film RES.	1/6W 47k ohm	UJ	C1020	K00175150	Ceramic CAP.	SL 50WV 15pF	
R1034	J02225823	Carbon Film RES.	1/6W 82k ohm	UJ	C1022	K00175101	Ceramic CAP.	SL 50WV 100pF	
R1035	J02225823	Carbon Film RES.	1/6W 82k ohm	UJ	C1023	K19149001	Ceramic CAP.	25WV 0.001uF	
R1036	J02225823	Carbon Film RES.	1/6W 82k ohm	UJ	C1024	K19149001	Ceramic CAP.	25WV 0.001uF	
R1037	J02225823	Carbon Film RES.	1/6W 82k ohm	UJ	C1025	K00175101	Ceramic CAP.	SL 50WV 100pF	
R1038	J40900031	Block RES.	1/8W 4.7k ohm	UJ	C1026	K00175101	Ceramic CAP.	SL 50WV 100pF	
R1039	J02225103	Carbon Film RES.	1/6W 10k ohm	UJ	C1027	K19149001	Ceramic CAP.	25WV 0.001uF	
R1040	J40900165	Block RES.	1/8W 10k ohm	UJ	C1028	K19149001	Ceramic CAP.	25WV 0.001uF	
R1041	J02225103	Carbon Film RES.	1/6W 10k ohm	UJ	C1029	K19149001	Ceramic CAP.	25WV 0.001uF	
R1042	J02225104	Carbon Film RES.	1/6W 100k ohm	UJ	C1030	K19149001	Ceramic CAP.	25WV 0.001uF	
R1043	J02225472	Carbon Film RES.	1/6W 4.7k ohm	UJ	C1031	K19149021	Ceramic CAP.	25WV 0.047uF	
R1044	J02225222	Carbon Film RES.	1/6W 2.2k ohm	UJ	C1032	K00175470	Ceramic CAP.	SL 25WV 47pF	
R1045	J02225331	Carbon Film RES.	1/6W 330 ohm	UJ	C1033	K19149021	Ceramic CAP.	25WV 0.047uF	
R1046	J02225472	Carbon Film RES.	1/6W 4.7k ohm	UJ	C1034	K19149021	Ceramic CAP.	25WV 0.047uF	
R1047	J02225681	Carbon Film RES.	1/6W 680 ohm	UJ	C1035	K00175330	Ceramic CAP.	SL 50WV 33pF	
R1048	J40900035	Block RES.	1/8W 10k ohm	UJ	C1036	K00175330	Ceramic CAP.	SL 50WV 33pF	
R1049	J02225472	Carbon Film RES.	1/6W 4.7k ohm	UJ	C1037	K70167105	Tantalum CAP.	35WV 1uF	
R1050	J40900164	Block RES.	1/8W 10k ohm	UJ	C1038	K19149005	Ceramic CAP.	25WV 0.0022uF	
R1052	J02225473	Carbon Film RES.	1/6W 47k ohm	UJ	C1039	K19149013	Ceramic CAP.	25WV 0.01uF	
R1053	J02225273	Carbon Film RES.	1/6W 27k ohm	UJ	C1040	K19149021	Ceramic CAP.	25WV 0.047uF	
R1054	J02225104	Carbon Film RES.	1/6W 100k ohm	UJ	C1041	K19149021	Ceramic CAP.	25WV 0.047uF	
R1057	J02225103	Carbon Film RES.	1/6W 10k ohm	UJ	C1042	K40179013	AL. Electro. CAP.	50WV 1uF	
R1058	J02225104	Carbon Film RES.	1/6W 100k ohm	UJ					
R1059	J02225124	Carbon Film RES.	1/6W 120k ohm	UJ	C1043**	K70147105	Tantalum CAP.	25WV 1uF	
R1060**	J02225473	Carbon Film RES.	1/6W 47k ohm	UJ	C1044	K19149021	Ceramic CAP.	25WV 0.047uF	
R1061**	J02225473	Carbon Film RES.	1/6W 47k ohm	UJ	C1045**	K12171102	Ceramic CAP.	E 50WV 0.001uF	
R1062**	J02225105	Carbon Film RES.	1/6W 1M ohm	UJ	C1046**	K00175330	Ceramic CAP.	SL 50WV 33pF	
R1063**	J02225223	Carbon Film RES.	1/6W 22k ohm	UJ	C1047**	K00175330	Ceramic CAP.	SL 50WV 33pF	
R1064**	J02225103	Carbon Film RES.	1/6W 10k ohm	UJ	C1048**	K19149013	Ceramic CAP.	25WV 0.01uF	
R1066**	J01225274	Carbon Film RES.	1/6W 270k ohm	PJ	C1049**	K19149013	Ceramic CAP.	25WV 0.01uF	
R1067**	J02225332	Carbon Film RES.	1/6W 3.3k ohm	UJ	C1050**	K19149021	Ceramic CAP.	25WV 0.047uF	
R1068**	J02225222	Carbon Film RES.	1/6W 2.2k ohm	UJ	C1051**	K40129004	AL. Electro. CAP.	16WV 10uF	
R1069	J02225224	Carbon Film RES.	1/6W 220k ohm	UJ					
R1070	J02225102	Carbon Film RES.	1/6W 1k ohm	UJ	C1052	K19149023	Ceramic CAP.	25WV 0.068uF	
R1071	J02225104	Carbon Film RES.	1/6W 100k ohm	UJ	C1053	K19149013	Ceramic CAP.	25WV 0.01uF	
R1072	J02225683	Carbon Film RES.	1/6W 68k ohm	UJ	C1054	K40179016	AL. Electro. CAP.	50WV 0.1uF	
R1073	J02225683	Carbon Film RES.	1/6W 68k ohm	UJ					
R1074	J02225103	Carbon Film RES.	1/6W 10k ohm	UJ	C1055	K19149013	Ceramic CAP.	25WV 0.01uF	
R1075	J02225332	Carbon Film RES.	1/6W 3.3k ohm	UJ	C1056	K00175101	Ceramic CAP.	SL 50WV 100pF	
R1076	J02225104	Carbon Film RES.	1/6W 100k ohm	UJ	C1057	K40129004	AL. Electro. CAP.	16WV 10uF	
R1077	J02225103	Carbon Film RES.	1/6W 10k ohm	UJ					
R1078	J02225472	Carbon Film RES.	1/6W 4.7k ohm	UJ	C1058	K40129004	AL. Electro. CAP.	16WV 10uF	
R1079	J02225472	Carbon Film RES.	1/6W 4.7k ohm	UJ					
R1080	J02225154	Carbon Film RES.	1/6W 150k ohm	UJ	C1059	K12171102	Ceramic CAP.	E 50WV 0.001uF	
R1081	J02225155	Carbon Film RES.	1/6W 1.5M ohm	UJ	C1060	K70167474	Tantalum CAP.	35WV 0.47uF	
R1082	J02225473	Carbon Film RES.	1/6W 47k ohm	UJ	C1061	K12171102	Ceramic CAP.	25WV 0.001uF	
R1083	J02225104	Carbon Film RES.	1/6W 100k ohm	UJ	C1062	K19149001	Ceramic CAP.	25WV 0.001uF	
R1084	J02225332	Carbon Film RES.	1/6W 3.3k ohm	UJ	C1063	K19149001	Ceramic CAP.	25WV 0.001uF	
R1085	J02225103	Carbon Film RES.	1/6W 10k ohm	UJ	C1064	K70137225	Tantalum CAP.	20WV 2.2uF	
R1086	J02225332	Carbon Film RES.	1/6W 3.3k ohm	UJ	C1066	K19149005	Ceramic CAP.	25WV 0.0022uF	
R1087	J02225103	Carbon Film RES.	1/6W 10k ohm	UJ	C1067	K22170227	CAP. Chip	CH 50WV 47pF	
R1088	J02225473	Carbon Film RES.	1/6W 47k ohm	UJ	C1068	K22170227	CAP. Chip	CH 50WV 47pF	

PARTS LIST

ENCODER UNIT			
Symbol No.	Part No.	Description	Device
	F2890107	Printed Circuit Board	
	C028907AA	PCB with Components	
S551	Q9000388	Rotary Code Switch	
J551	P0090525	Connector	

MODEL CHART

Symbol No.	Part No.	Description	Device	MODEL															
				A1	A2	B1	B2	B3	C1	C2	C3	H1	H2	H3	F				
144MHz MAIN UNIT	D6025	G2090408	Diode	1SS270	o	o		o	o		o	o		o	o		o	o	
	D6026	G2090408	Diode	1SS270	o	o	o	o	o	o	o	o	o	o	o	o	o	o	
	D6027	G2090408	Diode	1SS270		o	o		o	o		o	o		o	o		o	o
	D6030	G2090408	Diode	1SS270			o	o	o	o	o	o	o						o
	D6031	G2090408	Diode	1SS270															o
	D8004	G2090408	Diode	1SS270						o	o	o							o
430MHz PLL UNIT	D8005	G2090408	Diode	1SS270	o	o				o	o	o	o	o	o	o	o	o	
	D8006	G2090408	Diode	1SS270			o	o	o	o	o	o							
	D8007	G2090408	Diode	1SS270	o	o	o	o	o				o	o	o	o	o	o	
	D8008	G2090408	Diode	1SS270	o	o	o	o	o	o	o	o	o	o	o	o	o	o	
	D8010	G2090408	Diode	1SS270	o	o	o	o	o	o	o	o	o	o	o	o	o	o	
	D8011	G2090408	Diode	1SS270	o	o													o

MODEL	FREQUENCY RANGE		PRESET FREQUENCY		PRESET REPEATER SHIFT		TONE BURST
	2m BAND	70cm BAND	2m BAND	70cm BAND	2m BAND	70cm BAND	
A1	144 - 148 MHz	430 - 450 MHz	144.00 MHz	430.00 MHz	600 kHz	5 MHz	1800 Hz
A2	141 - 154 MHz	430 - 450 MHz	144.00 MHz	430.00 MHz	600 kHz	5 MHz	1800 Hz
B1	144 - 146 MHz	430 - 440 MHz	144.00 MHz	430.00 MHz	600 kHz	7.6 MHz	1750 Hz
B2	144 - 148 MHz	430 - 440 MHz	144.00 MHz	430.00 MHz	600 kHz	7.6 MHz	1750 Hz
B3	141 - 154 MHz	430 - 440 MHz	141.00 MHz	430.00 MHz	600 kHz	7.6 MHz	1750 Hz
C1	144 - 146 MHz	430 - 440 MHz	144.00 MHz	430.00 MHz	600 kHz	1.6 MHz	1750 Hz
C2	144 - 148 MHz	430 - 440 MHz	144.00 MHz	430.00 MHz	600 kHz	1.6 MHz	1750 Hz
C3	141 - 154 MHz	430 - 440 MHz	144.00 MHz	430.00 MHz	600 kHz	1.6 MHz	1750 Hz
H1	144 - 146 MHz	430 - 440 MHz	144.00 MHz	430.00 MHz	600 kHz	5 MHz	1750 Hz
H2	144 - 148 MHz	430 - 440 MHz	144.00 MHz	430.00 MHz	600 kHz	5 MHz	1750 Hz
H3	141 - 154 MHz	430 - 440 MHz	144.00 MHz	430.00 MHz	600 kHz	5 MHz	1750 Hz
F	144 - 146 MHz	430 - 440 MHz	144.00 MHz	430.00 MHz	600 kHz	5 MHz	-

(FEX-736-50) PARTS LIST

C1011	K13179008	Ceramic CAP.	F	50WV	0.01uF	C1106	K12171102	Ceramic CAP.	E	50WV	0.001uF
C1012	K05175220	Ceramic CAP.	RH	50WV	22pF	C1107	K13179008	Ceramic CAP.	F	50WV	0.01uF
C1013	K05173060	Ceramic CAP.	RH	50WV	6pF	C1108	K00175101	Ceramic CAP.	SL	50WV	100pF
C1014	K13179008	Ceramic CAP.	F	50WV	0.01uF	C1109	K00175101	Ceramic CAP.	SL	50WV	100pF
C1015	K12171102	Ceramic CAP.	E	50WV	0.001uF	C1110	K00175101	Ceramic CAP.	SL	50WV	100pF
C1017	K02172059	Ceramic CAP.	CK	50WV	0.5pF	C1111	K00175101	Ceramic CAP.	SL	50WV	100pF
C1018	K05173100	Ceramic CAP.	RH	50WV	10pF	C1112	K00175101	Ceramic CAP.	SL	50WV	100pF
C1019	K12171102	Ceramic CAP.	E	50WV	0.001uF	C1113	K00175101	Ceramic CAP.	SL	50WV	100pF
C1020	K05175220	Ceramic CAP.	RH	50WV	22pF	C1114	K70167104	Tantalum CAP.		35WV	0.1uF
C1021	K05175220	Ceramic CAP.	RH	50WV	22pF	C1115	K12171102	Ceramic CAP.	E	50WV	0.001uF
C1022	K19149021	Ceramic CAP.		25WV	0.047uF	C1116	K12171102	Ceramic CAP.	E	50WV	0.001uF
C1023	K19149021	Ceramic CAP.		25WV	0.047uF	C1117	K40109002	AL. Electro. CAP.		10WV	47uF
C1024	K13179008	Ceramic CAP.	F	50WV	0.01uF	C1118	K05173070	Ceramic CAP.	RH	50WV	7pF
C1025	K70147105	Tantalum CAP.		25WV	1uF	C1119	K05173100	Ceramic CAP.	RH	50WV	10pF
C1026	K13179008	Ceramic CAP.	F	50WV	0.01uF	C1120	K70147105	Tantalum CAP.		25WV	1uF
C1027	K19149025	Ceramic CAP.		25WV	0.1uF	C1121	K22141005	CAP. Chip	F	25WV	0.1uF
C1028	K40109001	AL. Electro. CAP.		10WV	100uF	C1122	K22170229	CAP. Chip	CH	50WV	56pF
C1029	K19149021	Ceramic CAP.		25WV	0.047uF	C1123	K22170229	CAP. Chip	CH	50WV	56pF
C1030	K70147105	Tantalum CAP.		25WV	1uF	C1124	K22170229	CAP. Chip	CH	50WV	56pF
C1032	K19149021	Ceramic CAP.		25WV	0.047uF	C1125	K22170229	CAP. Chip	CH	50WV	56pF
C1033	K12171102	Ceramic CAP.	E	50WV	0.001uF	C1126	K22170229	CAP. Chip	CH	50WV	56pF
C1034	K13179008	Ceramic CAP.	F	50WV	0.01uF	C1127	K22170229	CAP. Chip	CH	50WV	56pF
C1035	K19149025	Ceramic CAP.		25WV	0.1uF	C1128	K13179008	Ceramic CAP.	F	50WV	0.01uF
C1037	K12171102	Ceramic CAP.	E	50WV	0.001uF	C1129	K13179008	Ceramic CAP.	F	50WV	0.01uF
C1038	K05172040	Ceramic CAP.	RJ	50WV	4pF	C1130	K22170817	CAP. Chip	B	50WV	0.01uF
C1039	K06175101	Ceramic CAP.	UJ	50WV	100pF	C1131	K22170235	CAP. Chip	CH	50WV	100pF
C1040	K06175101	Ceramic CAP.	UJ	50WV	100pF						
C1041	K13179008	Ceramic CAP.	F	50WV	0.01uF	T1001	L0021358	Coil			
C1042	K40129004	AL. Electro. CAP.		16WV	10uF	T1002	L0021358	Coil			
C1043	K12171102	Ceramic CAP.	E	50WV	0.001uF	T1003	L0021358	Coil			
C1044	K02175101	Ceramic CAP.	CH	50WV	100pF	T1004	L0021358	Coil			
C1045	K13179008	Ceramic CAP.	F	50WV	0.01uF	T1005	L0021358	Coil			
C1046	K05175150	Ceramic CAP.	RH	50WV	15pF	L1001	L1190250	M.RFC		2.2uH	
C1047	K13179008	Ceramic CAP.	F	50WV	0.01uF	L1002	L1190250	M.RFC		2.2uH	
C1048	K13179008	Ceramic CAP.	F	50WV	0.01uF	L1003	L0190025	Coil			
C1049	K02179001	Ceramic CAP.	CK	50WV	1pF	L1004	L1190246	M.RFC		1uH	
C1050	K05175150	Ceramic CAP.	RH	50WV	15pF	L1006	L1190270	M.RFC		100uH	
C1051	K13179008	Ceramic CAP.	F	50WV	0.01uF	L1007	L1190262	M.RFC		22uH	
C1052	K13179008	Ceramic CAP.	F	50WV	0.01uF	L1008	L1190189	M.RFC		1mH	
C1053	K13179008	Ceramic CAP.	F	50WV	0.01uF	L1009	L0020652	Coil			
C1054	K05175150	Ceramic CAP.	RH	50WV	15pF	L1010	L1190270	M.RFC		100uH	
C1055	K13179008	Ceramic CAP.	F	50WV	0.01uF	L1011	L1190270	M.RFC		100uH	
C1056	K02172059	Ceramic CAP.	CK	50WV	0.5pF	L1012	L1190270	M.RFC		100uH	
C1057	K05175150	Ceramic CAP.	RH	50WV	15pF	L1013	L1190228	M.RFC		680uH	
C1058	K13179008	Ceramic CAP.	F	50WV	0.01uF	L1019	L1190246	M.RFC		1uH	
C1059	K02179001	Ceramic CAP.	CK	50WV	1pF	L1020	L1190270	M.RFC		100uH	
C1060	K13179008	Ceramic CAP.	F	50WV	0.01uF	L1021	L1190270	M.RFC		100uH	
C1061	K05172050	Ceramic CAP.	RH	50WV	5pF	L1022	L1190270	M.RFC		100uH	
C1062	K13179008	Ceramic CAP.	F	50WV	0.01uF	L1023	L1190257	M.RFC		8.2uH	
C1063	K40179011	AL. Electro. CAP.		50WV	3.3uF	L1024	L1190257	M.RFC		8.2uH	
C1065	K13179014	Ceramic CAP.	F	50WV	0.0047uF	L1026	L0021359	Coil			
C1066	K13179014	Ceramic CAP.	F	50WV	0.0047uF	L1027	L0021359	Coil			
C1067	K19149013	Ceramic CAP.		25WV	0.01uF	J1001	P0090525	Connector			
C1068	K40109001	AL. Electro. CAP.		10WV	100uF	J1002	P0090527	Connector			
C1069	K19149021	Ceramic CAP.		25WV	0.047uF	P1001	T9205550	Wire ASSY			
C1070	K70167474	Tantalum CAP.		35WV	0.47uF						
C1071	K19149013	Ceramic CAP.		25WV	0.01uF		R0110610	Spring Board			
C1072	K12171102	Ceramic CAP.	E	50WV	0.001uF		R0083860D	Shield Case			
C1076	K13179014	Ceramic CAP.	F	50WV	0.0047uF		R0510040	Shield Cover			
C1081	K05172020	Ceramic CAP.	RK	50WV	2pF		R0083880	Shield Bottom Cover			
C1082	K05172020	Ceramic CAP.	RK	50WV	2pF		R0062770B	VCO Case A			
C1084	K12171102	Ceramic CAP.	E	50WV	0.001uF		R0062780A	VCO Case Lid			
C1085	K19149025	Ceramic CAP.		25WV	0.1uF						
C1086	K13179014	Ceramic CAP.	F	50WV	0.0047uF						
C1087	K12171102	Ceramic CAP.	E	50WV	0.001uF						
C1088	K12171102	Ceramic CAP.	E	50WV	0.001uF						
C1089	K40109001	AL. Electro. CAP.		10WV	100uF						
C1090	K19149025	Ceramic CAP.		25WV	0.1uF						
C1091	K13179008	Ceramic CAP.	F	50WV	0.01uF						
C1092	K05172020	Ceramic CAP.	RK	50WV	2pF						
C1093	K70167474	Tantalum CAP.		35WV	0.47uF						
C1094	K19149021	Ceramic CAP.		25WV	0.047uF						
C1097	K05173070	Ceramic CAP.	RH	50WV	7pF	Q1016	G3805070F	FET		2SK507F	
C1098	K12171102	Ceramic CAP.	E	50WV	0.001uF	Q1017	G3333550	Transistor		2SC3355	
C1099	K13179014	Ceramic CAP.	F	50WV	0.0047uF	D1007	G2090180	Diode		FC53M-5	
C1100	K13179008	Ceramic CAP.	F	50WV	0.01uF	D1008	G2090180	Diode		FC53M-5	
C1101	K19149025	Ceramic CAP.		25WV	0.1uF						
C1102	K12171102	Ceramic CAP.	E	50WV	0.001uF	R1056	J02225330	Carbon Film RES.	1/6W	33 ohm	UJ
C1103	K05173100	Ceramic CAP.	RH	50WV	10pF	R1057	J01225221	Carbon Film RES.	1/6W	220 ohm	PJ
C1104	K12171102	Ceramic CAP.	E	50WV	0.001uF	R1058	J02225332	Carbon Film RES.	1/6W	3.3k ohm	UJ
C1105	K05173100	Ceramic CAP.	RH	50WV	10pF	R1059	J02225103	Carbon Film RES.	1/6W	10k ohm	UJ

PARTS LIST (FEX-736-50)

R1060	J02225101	Carbon Film RES.	1/6W	100 ohm	UJ	R2018	J01225470	Carbon Film RES.	1/6W	47 ohm	PJ
R1061	J01225101	Carbon Film RES.	1/6W	100 ohm	PJ	R2019	J01225221	Carbon Film RES.	1/6W	220 ohm	PJ
R1068	J01225102	Carbon Film RES.	1/6W	1k ohm	PJ	R2020	J01225820	Carbon Film RES.	1/6W	82 ohm	PJ
C1073	K05175180	Ceramic CAP.	RH	50WV	18pF	R2021	J01225221	Carbon Film RES.	1/6W	220 ohm	PJ
C1074	K12171102	Ceramic CAP.	E	50WV	0.001uF	R2022	J01225101	Carbon Film RES.	1/6W	100 ohm	PJ
C1075	K40109001	AL. Electro. CAP.		10WV	100uF	R2023	J01225470	Carbon Film RES.	1/6W	47 ohm	PJ
C1077	K05173100	Ceramic CAP.	UJ	50WV	10pF	R2024	J01225560	Carbon Film RES.	1/6W	56 ohm	PJ
C1078	K05173080	Ceramic CAP.	RH	50WV	8pF	R2025	J01225473	Carbon Film RES.	1/6W	47k ohm	PJ
C1079	K02172059	Ceramic CAP.	CK	50WV	0.5pF	R2026	J01225473	Carbon Film RES.	1/6W	47k ohm	PJ
C1080	K13179014	Ceramic CAP.	F	50WV	0.0047uF	R2027	J01225222	Carbon Film RES.	1/6W	2.2k ohm	PJ
C1083	K22171002	CAP. Chip	F	50WV	0.0047uF	R2028	J01225104	Carbon Film RES.	1/6W	100k ohm	PJ
C1095	K19149021	Ceramic CAP.		25WV	0.047uF	R2029	J01225104	Carbon Film RES.	1/6W	100k ohm	PJ
C1096	K12171102	Ceramic CAP.	E	50WV	0.001uF	R2030	J01225104	Carbon Film RES.	1/6W	100k ohm	PJ
L1014	L1190242	M. RFC		0.47uH		R2031	J01225104	Carbon Film RES.	1/6W	100k ohm	PJ
L1015	L1190242	M. RFC		0.47uH		R2033	J01225561	Carbon Film RES.	1/6W	560 ohm	PJ
L1016	L0190138	Coil				R2034	J01225221	Carbon Film RES.	1/6W	220 ohm	PJ
L1017	L0021520	Coil				R2035	J01225220	Carbon Film RES.	1/6W	22 ohm	PJ
L1018	L1190242	M. RFC		0.47uH		R2036	J01225479	Carbon Film RES.	1/6W	4.7 ohm	PJ
L1025	L0020852	Coil				R2037	J01225221	Carbon Film RES.	1/6W	220 ohm	PJ
L9190001		Ferrite Beads				R2038	J01225821	Carbon Film RES.	1/6W	820 ohm	PJ
50MHz RF UNIT						R2039	J01225103	Carbon Film RES.	1/6W	10k ohm	PJ
F2897101		Printed Circuit Board				R2040	J01225471	Carbon Film RES.	1/6W	470 ohm	PJ
C028971AA		PCB with Components				R2041	J01225103	Carbon Film RES.	1/6W	10k ohm	PJ
						R2042	J01275471	Carbon Film RES.	1/2W	470 ohm	TJ
						R2043	J01225473	Carbon Film RES.	1/6W	47k ohm	PJ
						R2044	J01225223	Carbon Film RES.	1/6W	22k ohm	PJ
						R2045	J01225223	Carbon Film RES.	1/6W	22k ohm	PJ
						R2046	J01225104	Carbon Film RES.	1/6W	100k ohm	PJ
						R2047	J01225473	Carbon Film RES.	1/6W	47k ohm	PJ
						R2048	J01225223	Carbon Film RES.	1/6W	22k ohm	PJ
						R2049	J01225103	Carbon Film RES.	1/6W	10k ohm	PJ
						R2050	J01225103	Carbon Film RES.	1/6W	10k ohm	PJ
						R2051	J01225104	Carbon Film RES.	1/6W	100k ohm	PJ
						R2052	J24205560	RES. Chip	1/10W	56 ohm	
Q2001	G4801220L	FET		3SK122L		VR2001	J51745101	POT.	B	100 ohm	
Q2002	G2090247	Diode		ND487C1-3R		VR2002	J51745101	POT.	B	100 ohm	
Q2003	G4801220L	FET		3SK122L		VR2003	J51745102	POT.	B	1k ohm	
Q2004	G3115280	Transistor		2SA1528		VR2004	J51745473	POT.	B	47k ohm	
Q2005	G3802410G	FET		2SK241GR		VR2005	J51745473	POT.	B	47k ohm	
Q2006	G3802410G	FET		2SK241GR		VR2006	J51745104	POT.	B	100k ohm	
Q2007	G3320260	Transistor		2SC2026		C2001	K05172050	Ceramic CAP.	RH	50WV	5pF
Q2008	G3325380	Transistor		2SC2538		C2002	K05175330	Ceramic CAP.	RH	50WV	33pF
Q2009	G3207720Q	Transistor		2SB772Q		C2003	K13179014	Ceramic CAP.	F	50WV	0.0047uF
Q2010	G3207720Q	Transistor		2SB772Q		C2004	K00175470	Ceramic CAP.	SL	50WV	47pF
Q2011	G1090606	IC		LA6358		C2005	K13179008	Ceramic CAP.	F	50WV	0.01uF
Q2012	G3115280	Transistor		2SA1528		C2006	K12171102	Ceramic CAP.	E	50WV	0.001uF
Q2013	G3090079	Transistor		BA1A4P		C2007	K13179008	Ceramic CAP.	F	50WV	0.01uF
D2001	G2022090	Diode		1S2209		C2008	K13179008	Ceramic CAP.	F	50WV	0.01uF
D2002	G2090027	Diode		1SS53		C2009	K13179008	Ceramic CAP.	F	50WV	0.01uF
D2003	G2022090	Diode		1S2209		C2010	K13179008	Ceramic CAP.	F	50WV	0.01uF
D2004	G2022090	Diode		1S2209		C2011	K02172020	Ceramic CAP.	CK	50WV	2pF
D2005	G2022090	Diode		1S2209		C2012	K05175330	Ceramic CAP.	RH	50WV	33pF
D2006	G2090027	Diode		1SS53		C2013	K05172050	Ceramic CAP.	RH	50WV	5pF
D2007	G2060004	Diode		1SS270TJ		C2014	K05175220	Ceramic CAP.	RH	50WV	22pF
D2008	G2090027	Diode		1SS53		C2015	K05173060	Ceramic CAP.	RH	50WV	6pF
D2009	G2090027	Diode		1SS53		C2016	K05175270	Ceramic CAP.	RH	50WV	27pF
D2010	G2090027	Diode		1SS53		C2017	K13179008	Ceramic CAP.	F	50WV	0.01uF
D2011	G2022090	Diode		1S2209		C2018	K02172050	Ceramic CAP.	CK	50WV	2
D2012	G2022090	Diode		1S2209		C2019	K05175270	Ceramic CAP.	RH	50WV	27
D2013	G2022090	Diode		1S2209		C2020	K05173060	Ceramic CAP.	RH	50WV	6pF
D2015	G2015550	Diode		1S1555		C2022	K13179014	Ceramic CAP.	F	50WV	0.0047uF
D2016	G2090408	Diode		1SS270		C2023	K13179014	Ceramic CAP.	F	50WV	0.0047uF
D2017	G2090383	Diode		MC911		C2025	K05175330	Ceramic CAP.	RH	50WV	33pF
D2018	G2090383	Diode		MC911		C2026	K13179008	Ceramic CAP.	F	50WV	0.01uF
D2019	G2060004	Diode		1SS270TJ		C2027	K13179008	Ceramic CAP.	F	50WV	0.01uF
D2020	G2090408	Diode		1SS270		C2028	K13179008	Ceramic CAP.	F	50WV	0.01uF
D2021	G2060004	Diode		1SS270TJ		C2029	K13179014	Ceramic CAP.	F	50WV	0.0047uF
TH2001	G9090026	Thermistor				C2030	K13179008	Ceramic CAP.	F	50WV	0.01uF
TH2002	G9090020	Thermistor				C2031	K13179014	Ceramic CAP.	F	50WV	0.0047uF
R2002	J01225104	Carbon Film RES.	1/6W	100k ohm	PJ	C2032	K13179008	Ceramic CAP.	F	50WV	0.01uF
R2003	J01225473	Carbon Film RES.	1/6W	47k ohm	PJ	C2033	K05173100	Ceramic CAP.	RH	50WV	10pF
R2004	J01225225	Carbon Film RES.	1/6W	2.2 Mohm	PJ	C2034	K05173100	Ceramic CAP.	RH	50WV	10pF
R2005	J01225470	Carbon Film RES.	1/6W	47 ohm	PJ	C2035	K12171102	Ceramic CAP.	E	50WV	0.001uF
R2006	J01225102	Carbon Film RES.	1/6W	1k ohm	PJ	C2036	K13179008	Ceramic CAP.	F	50WV	0.01uF
R2007	J01225470	Carbon Film RES.	1/6W	47 ohm	PJ	C2037	K13179008	Ceramic CAP.	F	50WV	0.01uF
R2008	J01225104	Carbon Film RES.	1/6W	100k ohm	PJ	C2038	K10179042	Ceramic CAP.	B	50WV	0.001uF
R2009	J01225104	Carbon Film RES.	1/6W	100k ohm	PJ	C2039	K05175330	Ceramic CAP.	RH	50WV	33pF
R2010	J01225104	Carbon Film RES.	1/6W	100k ohm	PJ	C2040	K12171102	Ceramic CAP.	E	50WV	0.001uF
R2011	J01225331	Carbon Film RES.	1/6W	330 ohm	PJ	C2041	K05172050	Ceramic CAP.	RH	50WV	5pF
R2012	J01225180	Carbon Film RES.	1/6W	18 ohm	PJ	C2042	K13179008	Ceramic CAP.	F	50WV	0.01uF
R2013	J01225331	Carbon Film RES.	1/6W	330 ohm	PJ	C2043	K05175220	Ceramic CAP.	RH	50WV	22pF
R2014	J01225473	Carbon Film RES.	1/6W	47k ohm	PJ	C2044	K05172050	Ceramic CAP.	RH	50WV	5pF
R2015	J01225473	Carbon Film RES.	1/6W	47k ohm	PJ	C2045	K05175330	Ceramic CAP.	RH	50WV	33pF
R2016	J01225473	Carbon Film RES.	1/6W	47k ohm	PJ	C2046	K02172059	Ceramic CAP.	CK	50WV	0.5pF
R2017	J01225470	Carbon Film RES.	1/6W	47 ohm	PJ						

PARTS LIST (FEX-736-220)

MAIN CHASSIS			
Symbol No.	Part No.	Description	Device
Q1	G1090778	IC	L7809
	T9205536A	Wire ASSY	
	T9205549	Wire ASSY	
	T9205552	Wire ASSY	
	T9205546	Wire ASSY	
	T9317800A	Wire ASSY	
	R0083771	UNIT CHASSIS	
	R0083790B	UNIT Bottom Cover	
	R0509970B	Shield Cover	
	R8123040	Seal "220 MHz"	
220MHz PLL UNIT			
Symbol No.	Part No.	Description	Device
	F2898102	Printed Circuit Board	
	C028982AA	PCB With Components: w/o 220 MHz SUB VCO UNIT	
	C028982AB	PCB With Components: w/ 220 MHz SUB VCO UNIT	
Q1001	G3801921G	FET	2SK192AGR
Q1002	G3802410G	FET	2SK241GR
Q1003	G3305350B	Transistor	2SC535B
Q1004	G3304580C	Transistor	2SC458C
Q1005	G3802410G	FET	2SK241GR
Q1006	G3305350B	Transistor	2SC535B
Q1007	G3304600B	Transistor	2SC460B
Q1008	G1090798	IC	MC145155P
Q1010	G3304600B	Transistor	2SC460B
Q1011	G3305350B	Transistor	2SC535B
Q1012	G3305350B	Transistor	2SC535B
Q1013	G3802410G	FET	2SK241GR
Q1014	G3305350B	Transistor	2SC535B
Q1015	G1090473	IC	TC5081AP
Q1019	G1090795	IC	MB504
Q1020	G1090707	IC	MC145156P
Q1022	G1090796	IC	MB505-16
Q1023	G1090247	IC	TC9122P
Q1024	G3304580C	Transistor	2SC458C
Q1025	G3304580C	Transistor	2SC458C
Q1026	G3304580C	Transistor	2SC458C
Q1027	G3304580C	Transistor	2SC458C
Q1028	G3304580C	Transistor	2SC458C
Q1029	G3304580C	Transistor	2SC458C
Q1030	G3304580C	Transistor	2SC458C
Q1031	G3304580C	Transistor	2SC458C
Q1032	G3090079	Transistor	BA1A4P
Q1033	G3090079	Transistor	BA1A4P
Q1034	G1090084	IC	uPC78L05
D1001	G2090271	Diode	1T33
D1002	G2090271	Diode	1T33
D1004	G2090408	Diode	1SS270
D1005	G2022090	Diode	1S2209
D1006	G2090384	Diode	HZ7C2
D1009	G2090408	Diode	1SS270
D1014	G2090408	Diode	1SS270
D1015	G2090408	Diode	1SS270
X1001	H0102814	XTAL	HC-49/T 20.5043 MHz
R1001	J01225474	Carbon Film RES.	1/6W 470k ohm PJ
R1002	J01225101	Carbon Film RES.	1/6W 100 ohm PJ
R1003	J01225101	Carbon Film RES.	1/6W 100 ohm PJ
R1004	J01225473	Carbon Film RES.	1/6W 47k ohm PJ
R1005	J01225470	Carbon Film RES.	1/6W 47 ohm PJ
R1006	J02225103	Carbon Film RES.	1/6W 10k ohm UJ
R1007	J02225223	Carbon Film RES.	1/6W 22k ohm UJ
R1008	J02225221	Carbon Film RES.	1/6W 220 ohm UJ
R1010	J02225470	Carbon Film RES.	1/6W 47 ohm UJ
R1011	J02225103	Carbon Film RES.	1/6W 10k ohm UJ
R1012	J02225562	Carbon Film RES.	1/6W 5.6k ohm UJ
R1013	J01225473	Carbon Film RES.	1/6W 47k ohm PJ
R1014	J02225471	Carbon Film RES.	1/6W 470 ohm UJ
R1015	J02225562	Carbon Film RES.	1/6W 5.6k ohm UJ
R1016	J02225223	Carbon Film RES.	1/6W 22k ohm UJ
R1017	J02225102	Carbon Film RES.	1/6W 1k ohm UJ
R1018	J02225473	Carbon Film RES.	1/6W 47k ohm UJ
R1019	J02225101	Carbon Film RES.	1/6W 100 ohm UJ
R1020	J02225471	Carbon Film RES.	1/6W 470 ohm UJ
R1021	J02225103	Carbon Film RES.	1/6W 10k ohm UJ
R1022	J01225222	Carbon Film RES.	1/6W 2.2k ohm PJ
R1023	J02225681	Carbon Film RES.	1/6W 680 ohm UJ
R1024	J01225471	Carbon Film RES.	1/6W 470 ohm PJ
R1025	J02225102	Carbon Film RES.	1/6W 1k ohm UJ
R1028	J01225472	Carbon Film RES.	1/6W 4.7k ohm PJ
R1029	J01225333	Carbon Film RES.	1/6W 33k ohm PJ
R1030	J01225473	Carbon Film RES.	1/6W 47k ohm PJ
R1031	J02225102	Carbon Film RES.	1/6W 1k ohm UJ
R1032	J02225101	Carbon Film RES.	1/6W 100 ohm UJ
R1033	J01225560	Carbon Film RES.	1/6W 56 ohm PJ
R1034	J01225223	Carbon Film RES.	1/6W 22k ohm PJ
R1035	J02225562	Carbon Film RES.	1/6W 5.6k ohm UJ
R1036	J01225681	Carbon Film RES.	1/6W 680 ohm PJ
R1037	J01225101	Carbon Film RES.	1/6W 100 ohm PJ
R1038	J02225223	Carbon Film RES.	1/6W 22k ohm UJ
R1039	J01225562	Carbon Film RES.	1/6W 5.6k ohm PJ
R1040	J02225331	Carbon Film RES.	1/6W 330 ohm UJ
R1041	J01225560	Carbon Film RES.	1/6W 56 ohm PJ
R1042	J01225331	Carbon Film RES.	1/6W 330 ohm PJ
R1043	J02225473	Carbon Film RES.	1/6W 47k ohm UJ
R1044	J02225471	Carbon Film RES.	1/6W 470 ohm UJ
R1046	J02225562	Carbon Film RES.	1/6W 5.6k ohm UJ
R1047	J02225223	Carbon Film RES.	1/6W 22k ohm UJ
R1048	J02225331	Carbon Film RES.	1/6W 330 ohm UJ
R1049	J02225102	Carbon Film RES.	1/6W 1k ohm UJ
R1050	J02225105	Carbon Film RES.	1/6W 1M ohm UJ
R1051	J02225560	Carbon Film RES.	1/6W 56 ohm UJ
R1052	J01225152	Carbon Film RES.	1/6W 1.5k ohm PJ
R1053	J02225332	Carbon Film RES.	1/6W 3.3k ohm UJ
R1054	J02225222	Carbon Film RES.	1/6W 2.2k ohm UJ
R1055	J01225104	Carbon Film RES.	1/6W 100k ohm PJ
R1063	J01225560	Carbon Film RES.	1/6W 56 ohm PJ
R1064	J02225222	Carbon Film RES.	1/6W 2.2k ohm UJ
R1065	J01225561	Carbon Film RES.	1/6W 560 ohm PJ
R1066	J01222221	Carbon Film RES.	1/6W 220 ohm PJ
R1067	J01225471	Carbon Film RES.	1/6W 470 ohm PJ
R1069	J01225560	Carbon Film RES.	1/6W 56 ohm PJ
R1070	J01225102	Carbon Film RES.	1/6W 1k ohm PJ
R1071	J01225560	Carbon Film RES.	1/6W 56 ohm PJ
R1072	J01225102	Carbon Film RES.	1/6W 1k ohm PJ
R1073	J01225562	Carbon Film RES.	1/6W 5.6k ohm PJ
R1075	J01225102	Carbon Film RES.	1/6W 1k ohm PJ
R1076	J01225562	Carbon Film RES.	1/6W 5.6k ohm PJ
R1078	J02225101	Carbon Film RES.	1/6W 100 ohm PJ
R1079	J01225473	Carbon Film RES.	1/6W 47k ohm PJ
R1080	J01225222	Carbon Film RES.	1/6W 2.2k ohm PJ
R1081	J01225473	Carbon Film RES.	1/6W 47k ohm UJ
R1082	J02225222	Carbon Film RES.	1/6W 2.2k ohm UJ
R1083	J01225473	Carbon Film RES.	1/6W 47k ohm PJ
R1084	J01225222	Carbon Film RES.	1/6W 2.2k ohm PJ
R1085	J02225473	Carbon Film RES.	1/6W 47k ohm UJ
R1086	J01225222	Carbon Film RES.	1/6W 2.2k ohm PJ
R1087	J01225473	Carbon Film RES.	1/6W 47k ohm PJ
R1088	J01225222	Carbon Film RES.	1/6W 2.2k ohm PJ
R1089	J01225473	Carbon Film RES.	1/6W 47k ohm PJ
R1090	J01225222	Carbon Film RES.	1/6W 2.2k ohm PJ
R1091	J01225102	Carbon Film RES.	1/6W 1k ohm PJ
C1001	K06173060	Ceramic CAP.	UJ 50WV 6pF
C1002	K02172020	Ceramic CAP.	CK 50WV 2pF
C1003	K02173060	Ceramic CAP.	CH 50WV 6pF
C1004	K05172050	Ceramic CAP.	RH 50WV 5pF
C1005	K06172050	Ceramic CAP.	UJ 50WV 5pF
C1006	K13179014	Ceramic CAP.	F 50WV 0.0047uF
C1007	K40109001	AL. Electro. CAP.	10WV 100uF
C1008	K02179001	Ceramic CAP.	CK 50WV 1pF
C1009	K13179008	Ceramic CAP.	F 50WV 0.01uF
C1010	K02172020	Ceramic CAP.	CK 50WV 2pF
C1011	K13179008	Ceramic CAP.	F 50WV 0.01uF
C1013	K05172040	Ceramic CAP.	RJ 50WV 4pF
C1014	K13179008	Ceramic CAP.	F 50WV 0.01uF
C1015	K12171102	Ceramic CAP.	E 50WV 0.001uF
C1017	K02172059	Ceramic CAP.	CK 50WV 0.5pF
C1018	K05173100	Ceramic CAP.	RH 50WV 10pF
C1019	K12171102	Ceramic CAP.	E 50WV 0.001uF
C1020	K05173100	Ceramic CAP.	RH 50WV 10pF
C1022	K19149021	Ceramic CAP.	25WV 0.047uF
C1023	K19149021	Ceramic CAP.	25WV 0.047uF
C1024	K13179008	Ceramic CAP.	F 50WV 0.01uF
C1025	K70147105	Tantalum CAP.	50WV 1uF

PARTS LIST (FEX-736-220)

Symbol No.	Part No.	Description	Device	Symbol No.	Part No.	Description	Device
	L9190001	Ferrite Beads		R2034	J01225180	Carbon Film RES.	1/6W 18 ohm PJ
220MHz RF UNIT				R2035	J01225331	Carbon Film RES.	1/6W 330 ohm PJ
	F2898101	Printed Circuit Board		R2036	J01225102	Carbon Film RES.	1/6W 1k ohm PJ
	C028981AA	PCB With Component		R2037	J01225221	Carbon Film RES.	1/6W 220 ohm PJ
Q2001	G4801220L	FET	3SK122L	R2038	J01225220	Carbon Film RES.	1/6W 22 ohm PJ
Q2002	G2090247	Diode	ND487C1-3R	R2039	J01225100	Carbon Film RES.	1/6W 10 ohm PJ
Q2003	G4801220L	FET	3SK122L	R2040	J01225102	Carbon Film RES.	1/6W 1k ohm PJ
Q2004	G4800810	FET	3SK81	R2041	J01225103	Carbon Film RES.	1/6W 10k ohm PJ
Q2005	G3115280	Transistor	2SA1528	R2042	J02225471	Carbon Film RES.	1/2W 470 ohm UJ
Q2006	G3802410G	FET	2SK241GR	R2043	J02225103	Carbon Film RES.	1/6W 10k ohm UJ
Q2007	G3802410G	FET	2SK241GR	R2044	J01275471	Carbon Film RES.	1/6W 470 ohm TJ
Q2008	G4801220L	FET	3SK122L	R2045	J01225473	Carbon Film RES.	1/6W 47k ohm PJ
Q2009	G2090135	Diode	ND487C2-3R	R2046	J01225223	Carbon Film RES.	1/6W 22k ohm PJ
Q2010	G3333550	Transistor	2SC3355	R2047	J01225223	Carbon Film RES.	1/6W 22k ohm PJ
Q2011	G3090050	Transistor	2SC2407(1)	R2048	J01225104	Carbon Film RES.	1/6W 100k ohm PJ
Q2012	G3207720Q	Transistor	2SB772Q	R2049	J01225473	Carbon Film RES.	1/6W 47k ohm PJ
Q2013	G3207720Q	Transistor	2SB772Q	R2050	J01225223	Carbon Film RES.	1/6W 22k ohm PJ
Q2014	G1090606	IC	LA6358	R2051	J01225103	Carbon Film RES.	1/6W 10k ohm PJ
Q2015	G3115280	Transistor	2SA1528	R2052	J01225223	Carbon Film RES.	1/6W 22k ohm PJ
Q2016	G3090079	Transistor	BA1A4P	R2057	J01225223	Carbon Film RES.	1/6W 22k ohm PJ
Q2018	G3305350B	Transistor	2SC535B	R2058	J01225472	Carbon Film RES.	1/6W 4.7k ohm PJ
Q2019	G3305350B	Transistor	2SC535B	R2059	J01225102	Carbon Film RES.	1/6W 1k ohm PJ
Q2020	G3801250	FET	2SK125	R2060	J01225101	Carbon Film RES.	1/6W 100 ohm PJ
D2001	G2060004	Diode	1SS270TJ	R2061	J01225470	Carbon Film RES.	1/6W 47 ohm PJ
D2002	G2090027	Diode	1SS53	R2062	J01225682	Carbon Film RES.	1/6W 6.8k ohm PJ
D2003	G2090027	Diode	1SS53	R2063	J01225223	Carbon Film RES.	1/6W 22k ohm PJ
D2004	G2060004	Diode	1SS270TJ	R2064	J01225102	Carbon Film RES.	1/6W 1k ohm PJ
D2005	G2090027	Diode	1SS53	R2065	J01225101	Carbon Film RES.	1/6W 100 ohm PJ
D2006	G2090027	Diode	1SS53	R2066	J01225222	Carbon Film RES.	1/6W 2.2k ohm PJ
D2007	G2060004	Diode	1SS270TJ	R2067	J01225560	Carbon Film RES.	1/6W 56 ohm PJ
D2008	G2090027	Diode	1SS53	R2068	J01225560	Carbon Film RES.	1/6W 56 ohm PJ
D2009	G2090027	Diode	1SS53	R2069	J01225221	Carbon Film RES.	1/6W 220 ohm PJ
D2010	G2015550	Diode	1S1555	R2070	J24205104	RES. Chip	1/10W 100k ohm
D2011	G2060004	Diode	1SS270TJ	R2071	J24205560	RES. Chip	1/10W 56 ohm
D2012	G2060004	Diode	1SS270TJ	R2072	J24205104	RES. Chip	1/10W 100k ohm
D2013	G2060004	Diode	1SS270TJ	R2073	J01225331	Carbon Film RES.	1/6W 330 ohm PJ
D2014	G2060004	Diode	1SS270TJ	C2001	K00175470	Ceramic CAP.	SL 50WV 47pF
D2015	G2060004	Diode	1SS270TJ	C2003	K13179008	Ceramic CAP.	F 50WV 0.01uF
D2016	G2060004	Diode	1SS270TJ	C2004	K12171102	Ceramic CAP.	E 50WV 0.001uF
D2017	G2060004	Diode	1SS270TJ	C2005	K13179008	Ceramic CAP.	F 50WV 0.01uF
D2018	G2060004	Diode	1SS270TJ	C2006	K13179008	Ceramic CAP.	F 50WV 0.01uF
TH2001	G9090026	Thermistor		C2007	K13179008	Ceramic CAP.	F 50WV 0.01uF
TH2002	G9090020	Thermistor		C2008	K13179008	Ceramic CAP.	F 50WV 0.01uF
XF2001	H1102122	XTAL Filter	47M20A1	C2009	K02172020	Ceramic CAP.	CK 50WV 2pF
R2001	J01225473	Carbon Film RES.	1/6W 47k ohm PJ	C2010	K12171102	Ceramic CAP.	E 50WV 0.001uF
R2002	J01225225	Carbon Film RES.	1/6W 2.2M ohm PJ	C2011	K13179014	Ceramic CAP.	F 50WV 0.0047uF
R2003	J01225470	Carbon Film RES.	1/6W 47 ohm PJ	C2013	K12171102	Ceramic CAP.	E 50WV 0.001uF
R2004	J01225102	Carbon Film RES.	1/6W 1k ohm PJ	C2014	K13179008	Ceramic CAP.	F 50WV 0.01uF
R2005	J01225470	Carbon Film RES.	1/6W 47 ohm PJ	C2015	K10179024	Ceramic CAP.	B 50WV 0.01uF
R2006	J01225151	Carbon Film RES.	1/6W 150 ohm PJ	C2016	K13179008	Ceramic CAP.	F 50WV 0.01uF
R2007	J01225331	Carbon Film RES.	1/6W 330 ohm PJ	C2017	K00175220	Ceramic CAP.	SL 50WV 22pF
R2008	J01225180	Carbon Film RES.	1/6W 18 ohm PJ	C2018	K12171102	Ceramic CAP.	E 50WV 0.001uF
R2009	J01225331	Carbon Film RES.	1/6W 330 ohm PJ	C2019	K13179008	Ceramic CAP.	F 50WV 0.01uF
R2010	J01225473	Carbon Film RES.	1/6W 47k ohm PJ	C2020	K05175150	Ceramic CAP.	RH 50WV 15pF
R2011	J01225473	Carbon Film RES.	1/6W 47k ohm PJ	C2021	K02173100	Ceramic CAP.	CH 50WV 10pF
R2012	J01225473	Carbon Film RES.	1/6W 47k ohm PJ	C2022	K13179008	Ceramic CAP.	F 50WV 0.01uF
R2013	J01225470	Carbon Film RES.	1/6W 47 ohm PJ	C2023	K13179014	Ceramic CAP.	F 50WV 0.0047uF
R2014	J01225470	Carbon Film RES.	1/6W 47 ohm PJ	C2024	K13179008	Ceramic CAP.	F 50WV 0.01uF
R2015	J01225473	Carbon Film RES.	1/6W 47k ohm PJ	C2025	K13179014	Ceramic CAP.	F 50WV 0.0047uF
R2016	J01225473	Carbon Film RES.	1/6W 47k ohm PJ	C2026	K13179008	Ceramic CAP.	F 50WV 0.01uF
R2017	J01225470	Carbon Film RES.	1/6W 47 ohm PJ	C2027	K00173060	Ceramic CAP.	SL 50WV 6pF
R2018	J01225471	Carbon Film RES.	1/6W 470 ohm PJ	C2028	K00173060	Ceramic CAP.	SL 50WV 6pF
R2019	J01225470	Carbon Film RES.	1/6W 47 ohm PJ	C2029	K13179008	Ceramic CAP.	F 50WV 0.01uF
R2020	J01225221	Carbon Film RES.	1/6W 220 ohm PJ	C2030	K13179008	Ceramic CAP.	F 50WV 0.01uF
R2021	J01225820	Carbon Film RES.	1/6W 82 ohm PJ	C2031	K13179008	Ceramic CAP.	F 50WV 0.01uF
R2022	J01225221	Carbon Film RES.	1/6W 220 ohm PJ	C2032	K02173100	Ceramic CAP.	CH 50WV 10pF
R2023	J01225101	Carbon Film RES.	1/6W 100 ohm PJ	C2033	K02172050	Ceramic CAP.	CH 50WV 5pF
R2024	J01225470	Carbon Film RES.	1/6W 47 ohm PJ	C2034	K13179008	Ceramic CAP.	F 50WV 0.01uF
R2025	J01225560	Carbon Film RES.	1/6W 56 ohm PJ	C2035	K13179008	Ceramic CAP.	F 50WV 0.01uF
R2026	J01225473	Carbon Film RES.	1/6W 47k ohm PJ	C2036	K13179008	Ceramic CAP.	F 50WV 0.01uF
R2027	J01225473	Carbon Film RES.	1/6W 47k ohm PJ	C2038	K12171102	Ceramic CAP.	E 50WV 0.001uF
R2028	J01225333	Carbon Film RES.	1/6W 33k ohm PJ	C2039	K12171102	Ceramic CAP.	E 50WV 0.001uF
R2029	J01225473	Carbon Film RES.	1/6W 47k ohm PJ	C2040	K13179014	Ceramic CAP.	F 50WV 0.0047uF
R2030	J01225223	Carbon Film RES.	1/6W 22k ohm PJ	C2042	K05173060	Ceramic CAP.	RH 50WV 6pF
R2031	J01225470	Carbon Film RES.	1/6W 47 ohm PJ	C2043	K13179008	Ceramic CAP.	F 50WV 0.01uF
R2032	J01225222	Carbon Film RES.	1/6W 2.2k ohm PJ	C2044	K13179008	Ceramic CAP.	F 50WV 0.01uF
R2033	J01225331	Carbon Film RES.	1/6W 330 ohm PJ	C2045	K05172030	Ceramic CAP.	RJ 50WV 3pF
				C2046	K05173090	Ceramic CAP.	RH 50WV 9pF
				C2047	K40129004	AL. Electro. CAP.	16WV 10uF
				C2048	K13179008	Ceramic CAP.	F 50WV 0.01uF
				C2049	K13179008	Ceramic CAP.	F 50WV 0.01uF
				C2050	K40129004	AL. Electro. CAP.	16WV 10uF
				C2051	K13179008	Ceramic CAP.	F 50WV 0.01uF

(FEX-736-220) PARTS LIST

				220MHz PA UNIT			
Symbol No.	Part No.	Description	Device				
C2052	K40129004	AL. Electro. CAP.	16WV	10uF			
C2053	K13179008	Ceramic CAP.	F	50WV	0.01uF		
C2054	K00173060	Ceramic CAP.	RH	50WV	6pF		
C2055	K05175120	Ceramic CAP.	RH	50WV	12pF		
C2056	K40109001	AL. Electro. CAP.		10WV	100uF		
C2057	K70167104	Tantalum CAP.		35WV	0.1uF		
C2058	K13179008	Ceramic CAP.	F	50WV	0.01uF		
C2059	K12171102	Ceramic CAP.	E	50WV	0.001uF		
C2060	K12171102	Ceramic CAP.	E	50WV	0.001uF		
C2061	K00175470	Ceramic CAP.	SL	50WV	47pF		
C2062	K13179008	Ceramic CAP.	F	50WV	0.01uF		
C2063	K00175470	Ceramic CAP.	SL	50WV	47pF		
C2064	K10176101	Ceramic CAP.	B	50WV	100pF		
C2065	K10176101	Ceramic CAP.	B	50WV	100pF		
C2066	K12171102	Ceramic CAP.	E	50WV	0.001uF		
C2067	K12171102	Ceramic CAP.	E	50WV	0.001uF		
C2068	K12171102	Ceramic CAP.	E	50WV	0.001uF		
C2069	K10176101	Ceramic CAP.	B	50WV	100pF		
C2070	K00173100	Ceramic CAP.	SL	50WV	10pF		
C2072	K12171102	Ceramic CAP.	E	50WV	0.001uF		
C2073	K13179008	Ceramic CAP.	F	50WV	0.01uF		
C2074	K13179008	Ceramic CAP.	F	50WV	0.01uF		
C2075	K13179008	Ceramic CAP.	F	50WV	0.01uF		
C2076	K02172059	Ceramic CAP.	CK	50WV	0.5pF		
C2077	K00175470	Ceramic CAP.	SL	50WV	47pF		
C2078	K13179008	Ceramic CAP.	F	50WV	0.01uF		
C2079	K13179008	Ceramic CAP.	F	50WV	0.01uF		
C2080	K13179008	Ceramic CAP.	F	50WV	0.01uF		
C2081	K13179008	Ceramic CAP.	F	50WV	0.01uF		
C2082	K13179008	Ceramic CAP.	F	50WV	0.01uF		
C2083	K13179008	Ceramic CAP.	F	50WV	0.01uF		
C2084	K13179008	Ceramic CAP.	F	50WV	0.01uF		
C2085	K13179008	Ceramic CAP.	F	50WV	0.01uF		
C2086	K13179008	Ceramic CAP.	F	50WV	0.01uF		
C2087	K02172059	Ceramic CAP.	CK	50WV	0.5pF		
C2088	K02172059	Ceramic CAP.	CK	50WV	0.5pF		
C2089	K02173060	Ceramic CAP.	CH	50WV	6pF		
C2090	K22170239	CAP. Chip	CH	50WV	150pF		
C2091	K22170239	CAP. Chip	CH	50WV	150pF		
C2092	K22140803	CAP. Chip	B	25WV	0.01uF		
C2093	K05172030	Ceramic CAP.	RJ	50WV	3pF		
C2094	K02179009	Ceramic CAP.	CH	50WV	22pF		
C2095	K13179009	Ceramic CAP.	F	50WV	0.047uF		
TC2002	K91000028	Variable CAP.		10pF			
T2001	L0021748	Coil					
T2002	L0021718	Coil					
T2003	L0021718	Coil					
T2004	L0021740	Coil					
T2005	L0021740	Coil					
T2006	L0021740	Coil					
T2007	L0021165	Coil					
T2008	L0021735	Coil					
T2009	L0021735	Coil					
T2010	L0021736	Coil					
T2011	L0021740	Coil					
T2012	L0021740	Coil					
T2013	L0021740	Coil					
T2014	L0021718	Coil					
T2015	L0021718	Coil					
T2016	L0021165	Coil					
T2017	L0021165	Coil					
T2018	L0021165	Coil					
L2001	L0021457	Coil					
L2002	L1190246	M. RFC		1uH			
L2003	L1190258	M. RFC		10uH			
L2004	L1190246	M. RFC		1uH			
L2005	L0020342	Coil					
L2006	L0020340	Coil					
L2007	L0020725	Coil					
L2009	L0020852	Coil					
L2010	L1020673	RFC					
L2011	L0020852	Coil					
L2012	L1190244	M. RFC		0.68uH			
CV2001	L4020085	Helical Resonator					
CV2002	L4020085	Helical Resonator					
J2001	P1090255	Connector					
J2002	P1090255	Connector					
J2003	P0090525	Connector					
J2004	P0090525	Connector					
J2005	P0090527	Connector					
J2006	P0090527	Connector					
J2007	P1090210	Connector					
J2008	P1090210	Connector					
P2001	T9205551	Wire ASSY					
	R0056640	PLL IF Shield					
Q3001	G1090797	IC				M67712	
D3001	G2090337	Diode				MI308	
D3002	G2090344	Diode				1SV178	
D3003	G2090344	Diode				1SV178	
D3004	G2090118	Diode				1SS97	
D3005	G2090118	Diode				1SS97	
R3001	J31309002	RES.		1W	0.1 ohm		
R3002	J31309002	RES.		1W	0.1 ohm		
R3003	J01275151	Carbon Film RES.		1/2W	150 ohm	TJ	
R3004	J02245103	Carbon Film RES.		1/4W	10k ohm	SJ	
R3005	J02245103	Carbon Film RES.		1/4W	10k ohm	SJ	
C3002	K10176102	Ceramic CAP.	B	50WV	0.001uF		
C3003	K13179008	Ceramic CAP.	F	50WV	0.01uF		
C3004	K40129004	AL. Electro. CAP.		16WV	10uF		
C3005	K10176102	Ceramic CAP.	B	50WV	0.001uF		
C3006	K13179008	Ceramic CAP.	F	50WV	0.01uF		
C3007	K40129004	AL. Electro. CAP.		16WV	10uF		
C3008	K10176102	Ceramic CAP.	B	50WV	0.001uF		
C3009	K13179008	Ceramic CAP.	F	50WV	0.01uF		
C3010	K40129004	AL. Electro. CAP.		16WV	10uF		
C3011	K02173100	Ceramic CAP.	CH	50WV	10pF		
C3013	K02175180	Ceramic CAP.	CH	50WV	18pF		
C3014	K02179001	Ceramic CAP.	CK	50WV	1pF		
C3016	K02173100	Ceramic CAP.	CH	50WV	10pF		
C3017	K02179001	Ceramic CAP.	CK	50WV	1pF		
C3018	K02173100	Ceramic CAP.	CH	50WV	10pF		
C3019	K02173100	Ceramic CAP.	CH	50WV	10pF		
C3020	K02173100	Ceramic CAP.	CH	50WV	10pF		
C3021	K02173100	Ceramic CAP.	CH	50WV	10pF		
C3022	K02173100	Ceramic CAP.	CH	50WV	10pF		
C3023	K02173100	Ceramic CAP.	CH	50WV	10pF		
C3024	K02173100	Ceramic CAP.	CH	50WV	10pF		
C3025	K02173150	Ceramic CAP.	CH	50WV	15pF		
C3027	K10176102	Ceramic CAP.	B	50WV	0.001uF		
C3028	K10176102	Ceramic CAP.	B	50WV	0.001uF		
C3029	K10176102	Ceramic CAP.	B	50WV	0.001uF		
C3030	K10176102	Ceramic CAP.	B	50WV	0.001uF		
C3031	K10176102	Ceramic CAP.	B	50WV	0.001uF		
C3032	K10176102	Ceramic CAP.	B	50WV	0.001uF		
C3034	K21170002	Feed Through CAP.		50WV	0.001uF		
C3035	K21170002	Feed Through CAP.		50WV	0.001uF		
C3036	K21170002	Feed Through CAP.		50WV	0.001uF		
C3037	K21170002	Feed Through CAP.		50WV	0.001uF		
C3038	K21170002	Feed Through CAP.		50WV	0.001uF		
L3001	L1020469	RFC					
L3002	L1020469	RFC					
L3003	L1020663	RFC					
L3004	L0021647	Coil					
L3005	L0021647	Coil					
L3006	L0021149	Coil					
L3007	L0021647	Coil					
L3008	L0021647	Coil					
L3009	L0021647	Coil					
L3010	L1190250	M. RFC		2.2uH			
L3011	L1190250	M. RFC		2.2uH			
J3001	P1090352	Connector					
	Q5000036	TP-G				MK-1095	
	T9307003	Wire ASSY					
	T9205537	Wire ASSY					
	S6000138	Beads					
	R4083840B	Booster Heatsink					
	R0083800B	Booster Cover A					
	R0083810B	Booster Cover B					
	R7043900	Insulator Board B					

PARTS LIST (FEX-736-1.2)

MAIN CHASSIS				R1002	J24205474	RES. Chip	1/10W 470k ohm
Symbol No.	Part No.	Description	Device	R1003	J24205474	RES. Chip	1/10W 470k ohm
	R0804800	Chassis		R1004	J24205474	RES. Chip	1/10W 470k ohm
	R0511100A	Shield Cover		R1005	J24205474	RES. Chip	1/10W 470k ohm
	R0511110	Shield Cover		R1006	J24205474	RES. Chip	1/10W 470k ohm
	R8123060	Seal		R1007	J24205333	RES. Chip	1/10W 33k ohm
	R0124540	Heatsink Plate		R1008	J24205333	RES. Chip	1/10W 33k ohm
	S5000057	Lead Clamper	L=38	R1009	J24205333	RES. Chip	1/10W 33k ohm
				R1010	J24205333	RES. Chip	1/10W 33k ohm
				R1011	J24205333	RES. Chip	1/10W 33k ohm
				R1012	J24205333	RES. Chip	1/10W 33k ohm
1200MHz PLL UNIT *				R1013	J24205102	RES. Chip	1/10W 1k ohm
Symbol No.	Part No.	Description	Device	R1014	J24205562	RES. Chip	1/10W 5.6k ohm
	F2951000A	Printed Circuit Board		R1015	J24205101	RES. Chip	1/10W 100 ohm
	C029510AA	PCB with Components: Vers. F		R1016	J24205102	RES. Chip	1/10W 1k ohm
	C029510AB	PCB with Components: Vers. A		R1017	J24205562	RES. Chip	1/10W 5.6k ohm
	C029510AC	PCB with Components: Vers. B		R1018	J01225101	Carbon Film RES.	1/6W 100 ohm PJ
				R1019	J24205102	RES. Chip	1/10W 1k ohm
				R1020	J24205222	RES. Chip	1/10W 2.2k ohm
				R1021	J24205103	RES. Chip	1/10W 10k ohm
				R1022	J24205103	RES. Chip	1/10W 10k ohm
				R1023	J24205152	RES. Chip	1/10W 1.5k ohm
				R1024	J24205222	RES. Chip	1/10W 2.2k ohm
				R1025	J01225471	Carbon Film RES.	1/6W 470 ohm PJ
Q1001	G3316237F	Transistor	2SC1623 T2BL6	R1026	J24205102	RES. Chip	1/10W 1k ohm
Q1002	G3316237F	Transistor	2SC1623 T2BL6	R1027	J24205104	RES. Chip	1/10W 100k ohm
Q1003	G3316237F	Transistor	2SC1623 T2BL6	R1028	J24205104	RES. Chip	1/10W 100k ohm
Q1004	G3316237F	Transistor	2SC1623 T2BL6	R1029	J24205330	RES. Chip	1/10W 33 ohm
Q1005	G3316237F	Transistor	2SC1623 T2BL6	R1030	J24205221	RES. Chip	1/10W 220 ohm
Q1006	G3316237F	Transistor	2SC1623 T2BL6	R1031	J24205103	RES. Chip	1/10W 10k ohm
Q1007	G3316237F	Transistor	2SC1623 T2BL6	R1032	J24205332	RES. Chip	1/10W 3.3k ohm
Q1008	G3316237F	Transistor	2SC1623 T2BL6	R1033	J24205471	RES. Chip	1/10W 470 ohm
Q1009	G3327127G	Transistor	2SC2712GR TE85R	R1034	J24205152	RES. Chip	1/10W 1.5k ohm
Q1010	G3327127G	Transistor	2SC2712GR TE85R	R1035	J24205470	RES. Chip	1/10W 47 ohm
Q1011	G1090824	IC	MB504L	R1036	J24205683	RES. Chip	1/10W 68k ohm
Q1012	G1090707	IC	MC145156L	R1037	J24205221	RES. Chip	1/10W 220 ohm
Q1013	G3805070F	FET	2SK507F	R1038	J24205102	RES. Chip	1/10W 1k ohm
Q1014	G3331207	Transistor	2SC3120 TE85R	R1039	J24205683	RES. Chip	1/10W 68k ohm
Q1015	G3331207	Transistor	2SC3120 TE85R	R1040	J24205221	RES. Chip	1/10W 220 ohm
Q1016	G3331207	Transistor	2SC3120 TE85R	R1041	J24205222	RES. Chip	1/10W 2.2k ohm
Q1017	G1090796	IC	MB505-16	R1042	J24205101	RES. Chip	1/10W 100 ohm
Q1018	G3316237F	Transistor	2SC1623 T2BL6	R1043	J24205223	RES. Chip	1/10W 22k ohm
Q1019	G3803027Y	FET	2SK302Y TE85R	R1044	J24205222	RES. Chip	1/10W 2.2k ohm
Q1020	G1090247	IC	TC9122P	R1045	J24205101	RES. Chip	1/10W 100 ohm
Q1021	G3326207B	Transistor	2SC2620 QB	R1046	J24205101	RES. Chip	1/10W 100 ohm
Q1022	G1090072	IC	uPC577H	R1047	J24205102	RES. Chip	1/10W 1k ohm
Q1023	G1090473	IC	TC5081AP	R1048	J24205101	RES. Chip	1/10W 100 ohm
Q1024	G3326207B	Transistor	2SC2620 QB	R1049	J24205102	RES. Chip	1/10W 1k ohm
Q1025	G3803027Y	FET	2SK302Y	R1050	J24205562	RES. Chip	1/10W 5.6k ohm
Q1026	G3331207	Transistor	2SC3120 TE85R	R1051	J24205102	RES. Chip	1/10W 1k ohm
Q1027	G1090653	IC	uPC1651G	R1052	J24205332	RES. Chip	1/10W 3.3k ohm
Q1028	G1090822	IC	uPC1659G	R1053	J24205560	RES. Chip	1/10W 56 ohm
Q1029	G48016570	FET	3SK165-O-T7	R1054	J24205472	RES. Chip	1/10W 4.7k ohm
Q1030	G1090653	IC	uPC1651G	R1055	J24205103	RES. Chip	1/10W 10k ohm
Q1031	G1090860	IC	MB503	R1056	J24205222	RES. Chip	1/10W 2.2k ohm
Q1032	G3108127F	Transistor	2SA812 T2EM6B	R1057	J24205104	RES. Chip	1/10W 100k ohm
Q1033	G1090707	IC	MC145156P	R1058	J24205222	RES. Chip	1/10W 2.2k ohm
Q1034	G3333567	Transistor	2SC3356 T2B	R1059	J24205472	RES. Chip	1/10W 4.7k ohm
Q1035	G3327127G	Transistor	2SC2712GR TE85R	R1060	J24205472	RES. Chip	1/10W 4.7k ohm
Q1036	G1090739	IC	MC145163SL	R1061	J24205152	RES. Chip	1/10W 1.5k ohm
Q1037	G1090292	IC	uPB551C	R1062	J24205101	RES. Chip	1/10W 100 ohm
Q1038	G3801921G	FET	2SK192AGR	R1063	J01225470	Carbon Film RES.	1/6W 47 ohm PJ
Q1039	G3326207B	Transistor	2SC2620QB	R1064	J24205471	RES. Chip	1/10W 470 ohm
Q1040	G3326207B	Transistor	2SC2620QB	R1065	J24205471	RES. Chip	1/10W 470 ohm
Q1041	G1090299	IC	uPC7805H	R1066	J24205102	RES. Chip	1/10W 1k ohm
				R1067	J24205472	RES. Chip	1/10W 4.7k ohm
D1001	G2090408	Diode	1SS270	R1068	J24205330	RES. Chip	1/10W 33 ohm
D1002	G2090408	Diode	1SS270	R1069	J24205221	RES. Chip	1/10W 220 ohm
D1003(F)	G2090408	Diode	1SS270	R1070	J01225100	Carbon Film RES.	1/6W 10 ohm PJ
D1004	G2090408	Diode	1SS270	R1071	J24205101	RES. Chip	1/10W 100 ohm
D1005	G2090408	Diode	1SS270	R1072	J24205471	RES. Chip	1/10W 470 ohm
D1006	G2090408	Diode	1SS270	R1073	J01225470	Carbon Film RES.	1/6W 47 ohm PJ
D1007(B)	G2090408	Diode	1SS270	R1074	J24205101	RES. Chip	1/10W 100 ohm
D1008	G2090408	Diode	1SS270	R1075	J24205222	RES. Chip	1/10W 2.2k ohm
D1009	G2090271	Diode	1T33	R1076	J24205103	RES. Chip	1/10W 10k ohm
D1010	G2090271	Diode	1T33	R1077	J24205103	RES. Chip	1/10W 10k ohm
D1011	G2090384	Diode	HZ7C2	R1078	J01225104	Carbon Film RES.	1/6W 100k ohm PJ
D1012	G2022080	Diode	1S2208	R1079	J24205473	RES. Chip	1/10W 47k ohm
D1013	G2090248	Diode	1T32	R1080	J24205103	RES. Chip	1/10W 10k ohm
				R1081	J24205152	RES. Chip	1/10W 1.5k ohm
				R1082	J24205681	RES. Chip	1/10W 680 ohm
X1001	H0102844	XTAL	HC-49/U-3P 71.690 MHz	R1083	J01225151	Carbon Film RES.	1/6W 150 ohm PJ
				R1084	J24205102	RES. Chip	1/10W 1k ohm
XM1001	Q7000072	VCO Module	ENF-VCO 06A01	R1085	J01225470	Carbon Film RES.	1/6W 47 ohm PJ
				R1086	J24205181	RES. Chip	1/10W 180 ohm
R1001	J24205474	RES. Chip	1/10W 470k ohm	R1087	J24205680	RES. Chip	1/10W 68 ohm
				R1088	J24205331	RES. Chip	1/10W 330 ohm

(FEX-736-1.2) PARTS LIST

R1089	J24205182	RES. Chip	1/10W 1.8k ohm		C1058	K22170210	CAP. Chip	CH	50WV	9pF
R1090	J01225331	Carbon Film RES.	1/6W 330 ohm		C1059	K22170215	CAP. Chip	CH	50WV	15pF
R1091	J24205102	RES. Chip	1/10W 1k ohm		C1060	K22170210	CAP. Chip	CH	50WV	9pF
R1092	J24205562	RES. Chip	1/10W 5.6k ohm		C1061	K22170202	CAP. Chip	CH	50WV	1pF
R1093	J24205101	RES. Chip	1/10W 100 ohm		C1062	K22170210	CAP. Chip	CH	50WV	9pF
R1094	J24205151	RES. Chip	1/10W 150 ohm		C1063	K22170210	CAP. Chip	CH	50WV	9pF
R1095	J24205222	RES. Chip	1/10W 2.2k ohm		C1064	K22170817	CAP. Chip	B	50WV	0.01uF
R1096	J01225334	Carbon Film RES.	1/6W 330k ohm	PJ	C1065	K22170817	CAP. Chip	B	50WV	0.01uF
R1097	J24205104	RES. Chip	1/10W 100k ohm		C1066	K40179007	AL. Electro. CAP.		50WV	3.3uF
R1098	J01225101	Carbon Film RES.	1/6W 100 ohm	PJ						
R1099	J24205221	RES. Chip	1/10W 220 ohm		C1067	K22170817	CAP. Chip	B	50WV	0.01uF
R1100	J24205103	RES. Chip	1/10W 10k ohm		C1068	K40129004	AL. Electro. CAP.		16WV	10uF
R1101	J24205103	RES. Chip	1/10W 10k ohm							
R1102	J24205101	RES. Chip	1/10W 100 ohm		C1070	K22170203	CAP. Chip	CH	50WV	2pF
R1103	J24205471	RES. Chip	1/10W 470 ohm		C1071	K22170813	CAP. Chip	B	50WV	0.0047uF
R1104	J24205103	RES. Chip	1/10W 10k ohm		C1072	K22170813	CAP. Chip	B	50WV	0.0047uF
R1105	J24205101	RES. Chip	1/10W 100 ohm		C1073	K22141809	CAP. Chip	B	25WV	0.1uF
R1106	J24205103	RES. Chip	1/10W 10k ohm		C1074	K22141809	CAP. Chip	B	25WV	0.1uF
R1107	J24205222	RES. Chip	1/10W 2.2k ohm		C1075	K40129004	AL. Electro. CAP.		16WV	10uF
R1108	J24205223	RES. Chip	1/10W 22k ohm							
R1109	J01225151	Carbon Film RES.	1/6W 150 ohm	PJ	C1076	K22141809	CAP. Chip	B	25WV	0.1uF
R1110	J24205101	RES. Chip	1/10W 100 ohm		C1077	K40129004	AL. Electro. CAP.		16WV	10uF
R1111	J24205000	RES. Chip	1/10W 0 ohm							
R1112	J24205000	RES. Chip	1/10W 0 ohm		C1078	K40129004	AL. Electro. CAP.		16WV	10uF
R1113	J24205000	RES. Chip	1/10W 0 ohm							
R1114	J24205103	RES. Chip	1/10W 10k ohm		C1079	K22141809	CAP. Chip	B	25WV	0.1uF
R1115	J24205103	RES. Chip	1/10W 10k ohm		C1080	K40109024	AL. Electro. CAP.		10WV	100uF
C1001	K22170235	CAP. Chip	CH	50WV 100pF	C1081	K70167104	Tantalum CAP.		35WV	0.1uF
002	K22170235	CAP. Chip	CH	50WV 100pF	C1084	K22170306	CAP. Chip	UJ	50WV	5pF
003	K22170235	CAP. Chip	CH	50WV 100pF	C1085	K22170223	CAP. Chip	CH	50WV	33pF
C1004	K22170235	CAP. Chip	CH	50WV 100pF	C1086	K22170227	CAP. Chip	CH	50WV	47pF
C1005	K22170235	CAP. Chip	CH	50WV 100pF	C1087	K22170817	CAP. Chip	B	50WV	0.01uF
C1006	K22170235	CAP. Chip	CH	50WV 100pF	C1088	K22170210	CAP. Chip	CH	50WV	9pF
C1007	K22170235	CAP. Chip	CH	50WV 100pF	C1089	K22170817	CAP. Chip	B	50WV	0.01uF
C1008	K22170235	CAP. Chip	CH	50WV 100pF	C1090	K22170805	CAP. Chip	B	50WV	0.001uF
C1009	K22170235	CAP. Chip	CH	50WV 100pF	C1091	K22170817	CAP. Chip	B	50WV	0.01uF
C1010	K22170235	CAP. Chip	CH	50WV 100pF	C1092	K22170817	CAP. Chip	B	50WV	0.01uF
C1011	K22170235	CAP. Chip	CH	50WV 100pF	C1093	K22170206	CAP. Chip	CH	50WV	5pF
C1012	K22170235	CAP. Chip	CH	50WV 100pF	C1094	K22170210	CAP. Chip	CH	50WV	9pF
C1013	K22170235	CAP. Chip	CH	50WV 100pF	C1095	K22170817	CAP. Chip	B	50WV	0.01uF
C1014	K22170235	CAP. Chip	CH	50WV 100pF	C1096	K22170215	CAP. Chip	CH	50WV	15pF
C1015	K22170235	CAP. Chip	CH	50WV 100pF	C1097	K22170817	CAP. Chip	CH	50WV	0.01uF
C1016	K22170235	CAP. Chip	CH	50WV 100pF	C1098	K22170235	CAP. Chip	CH	50WV	100pF
C1017	K22170219	CAP. Chip	CH	50WV 22pF	C1099	K22170817	CAP. Chip	B	50WV	0.01uF
C1018	K22170229	CAP. Chip	CH	50WV 56pF	C1100	K22170235	CAP. Chip	CH	50WV	100pF
C1019	K22170817	CAP. Chip	B	50WV 0.01uF	C1101	K22170805	CAP. Chip	B	50WV	0.001uF
C1020	K22170211	CAP. Chip	CH	50WV 10pF	C1102	K22170817	CAP. Chip	B	50WV	0.01uF
C1021	K22170229	CAP. Chip	CH	50WV 56pF	C1103	K22170235	CAP. Chip	CH	50WV	100pF
C1022	K22170817	CAP. Chip	B	50WV 0.01uF	C1104	K22170235	CAP. Chip	CH	50WV	100pF
C1023	K22170813	CAP. Chip	B	50WV 0.0047uF	C1105	K22170805	CAP. Chip	B	50WV	0.001uF
C1024	K22141809	CAP. Chip	B	25WV 0.1uF	C1106	K22170805	CAP. Chip	B	50WV	0.001uF
C1025	K22170805	CAP. Chip	B	50WV 0.01uF	C1107	K22170805	CAP. Chip	B	50WV	0.001uF
C1026	K22170805	CAP. Chip	B	50WV 0.01uF	C1111	K22170805	CAP. Chip	B	50WV	0.001uF
C1027	K22170805	CAP. Chip	B	50WV 0.01uF	C1112	K22170805	CAP. Chip	B	50WV	0.001uF
C1028	K40109024	AL. Electro. CAP.		10WV 100uF	C1113	K22170219	CAP. Chip	CH	50WV	22pF
					C1114	K22170219	CAP. Chip	CH	50WV	22pF
C1029	K22141809	CAP. Chip	B	25WV 0.1uF	C1115	K22170817	CAP. Chip	B	50WV	0.01uF
C1030	K22170817	CAP. Chip	B	50WV 0.01uF	C1116	K22141809	CAP. Chip	B	25WV	0.1uF
031	K22170805	CAP. Chip	B	50WV 0.001uF	C1117	K22170817	CAP. Chip	B	50WV	0.01uF
032	K70167334	Tantalum CAP.		35WV 0.33uF	C1119	K22170805	CAP. Chip	B	50WV	0.001uF
C1033	K19149021	Ceramic CAP.		25WV 0.047uF	C1120	K22170805	CAP. Chip	B	50WV	0.001uF
C1034	K19149021	Ceramic CAP.		25WV 0.047uF	C1122	K22170805	CAP. Chip	B	50WV	0.001uF
C1035	K22170817	CAP. Chip	B	50WV 0.01uF	C1123	K22170805	CAP. Chip	B	50WV	0.001uF
C1036	K22170805	CAP. Chip	B	50WV 0.001uF	C1124	K22170817	CAP. Chip	B	50WV	0.01uF
C1037	K40109024	AL. Electro. CAP.		10WV 100uF	C1125	K40179013	AL. Electro. CAP.		50WV	1uF
C1038	K22170813	CAP. Chip	B	50WV 0.0047uF	C1126	K40179013	AL. Electro. CAP.		50WV	1uF
C1039	K22170209	CAP. Chip	CH	50WV 8pF						
C1040	K22170215	CAP. Chip	CH	50WV 15pF	C1127	K22170817	CAP. Chip	B	50WV	0.01uF
C1041	K22170201	CAP. Chip	CH	50WV 0.5pF	C1128	K40109024	AL. Electro. CAP.		10WV	100uF
C1042	K22170205	CAP. Chip	CH	50WV 4pF						
C1043	K22170813	CAP. Chip	B	50WV 0.0047uF	C1129	K22141809	CAP. Chip	B	25WV	0.1uF
C1044	K22170203	CAP. Chip	CH	50WV 2pF	C1130	K70137225	Tantalum CAP.		20WV	2.2uF
C1045	K22170203	CAP. Chip	CH	50WV 2pF	C1131	K19149025	Ceramic CAP.		25WV	0.1uF
C1046	K22170813	CAP. Chip	B	50WV 0.0047uF	C1132	K22170805	CAP. Chip	B	50WV	0.001uF
C1047	K22170813	CAP. Chip	B	50WV 0.0047uF	C1133	K19149025	Ceramic CAP.		25WV	0.1uF
C1048	K22141809	CAP. Chip	B	25WV 0.1uF	C1134	K22170235	CAP. Chip	CH	50WV	100pF
C1049	K22141809	CAP. Chip	B	25WV 0.1uF	C1135	K22170805	CAP. Chip	B	50WV	0.001uF
C1050	K22170813	CAP. Chip	B	50WV 0.0047uF	C1136	K22170235	CAP. Chip	CH	50WV	100pF
C1051	K22170813	CAP. Chip	B	50WV 0.0047uF	C1137	K40109004	AL. Electro. CAP.		10WV	470uF
C1052	K22170805	CAP. Chip	B	50WV 0.001uF						
C1053	K22170817	CAP. Chip	B	50WV 0.01uF	C1138	K22170805	CAP. Chip	B	50WV	0.001uF
C1054	K22170805	CAP. Chip	B	50WV 0.001uF	C1139	K22170235	CAP. Chip	CH	50WV	100pF
C1055	K22170817	CAP. Chip	B	50WV 0.01uF	C1140	K22170817	CAP. Chip	B	50WV	0.01uF
C1056	K22170805	CAP. Chip	B	50WV 0.001uF	C1141	K22170204	CAP. Chip	CH	50WV	3pF
C1057	K22170805	CAP. Chip	B	50WV 0.001uF	C1142	K22170204	CAP. Chip	CH	50WV	3pF

(FEX-736-1.2) PARTS LIST

R2008	J01225272	Carbon Film RES.	1/6W 2.7k ohm	PJ	R2095	J24205223	RES. Chip	1/10W 22k ohm	
R2009	J24205150	RES. Chip	1/10W 15 ohm		R2100	J01225104	Carbon Film RES.	1/6W 100k ohm	PJ
R2010	J24205101	RES. Chip	1/10W 100 ohm		R2101	J01225470	Carbon Film RES.	1/6W 47 ohm	
R2011	J24205473	RES. Chip	1/10W 47k ohm		R2102	J24205223	RES. Chip	1/10W 22k ohm	
R2012	J01225103	Carbon Film RES.	1/6W 10k ohm	PJ	R2103	J24205470	RES. Chip	1/10W 47 ohm	
R2013	J24205470	RES. Chip	1/10W 47 ohm						
R2014	J01225471	Carbon Film RES.	1/6W 470 ohm	PJ	VR2001	J51747104	POT.	B 100k ohm	
R2015	J24205101	RES. Chip	1/10W 100 ohm		VR2002	J51745473	POT.	B 47k ohm	
R2016	J24205680	RES. Chip	1/10W 68 ohm		VR2003	J51745224	POT.	B 220k ohm	
R2017	J24205101	RES. Chip	1/10W 100 ohm		VR2004	J51745471	POT.	B 470 ohm	
R2018	J24205331	RES. Chip	1/10W 330 ohm		VR2005	J51745101	POT.	B 100 ohm	
R2019	J24205471	RES. Chip	1/10W 470 ohm		VR2006	J51745222	POT.	B 2.2k ohm	
R2020	J24205473	RES. Chip	1/10W 47k ohm						
R2021	J24205225	RES. Chip	1/10W 2.2M ohm		C2001	K22170215	CAP. Chip	CH 50WV 15pF	
R2022	J24205470	RES. Chip	1/10W 47 ohm		C2002	K22170209	CAP. Chip	CH 50WV 8pF	
R2023	J24205102	RES. Chip	1/10W 1k ohm		C2003	K22170206	CAP. Chip	CH 50WV 5pF	
R2024	J24205560	RES. Chip	1/10W 56 ohm		C2004	K22170235	CAP. Chip	CH 50WV 100pF	
R2025	J24205222	RES. Chip	1/10W 2.2k ohm		C2005	K22170235	CAP. Chip	CH 50WV 100pF	
R2026	J24205222	RES. Chip	1/10W 2.2k ohm		C2006	K22170211	CAP. Chip	CH 50WV 10pF	
R2027	J24205102	RES. Chip	1/10W 1k ohm		C2007	K22170805	CAP. Chip	B 50WV 0.001uF	
R2028	J24205103	RES. Chip	1/10W 10k ohm		C2008	K22170211	CAP. Chip	CH 50WV 10pF	
R2029	J24205102	RES. Chip	1/10W 1k ohm		C2009	K22170805	CAP. Chip	B 50WV 0.001uF	
R2031	J24205222	RES. Chip	1/10W 2.2k ohm		C2010	K22170204	CAP. Chip	CH 50WV 3pF	
R2032	J24205331	RES. Chip	1/10W 330 ohm		C2011	K22170235	CAP. Chip	CH 50WV 100pF	
R2033	J24205180	RES. Chip	1/10W 18 ohm		C2012	K22170235	CAP. Chip	CH 50WV 100pF	
R2034	J24205331	RES. Chip	1/10W 330 ohm		C2013	K22170235	CAP. Chip	CH 50WV 100pF	
R2035	J24205180	RES. Chip	1/10W 18 ohm		C2014	K22170211	CAP. Chip	CH 50WV 10pF	
R2036	J24205331	RES. Chip	1/10W 330 ohm		C2015	K22170805	CAP. Chip	B 50WV 0.001uF	
R2037	J24205220	RES. Chip	1/10W 22 ohm		C2016	K22170203	CAP. Chip	CH 50WV 2pF	
R2038	J20206330	Metalic Film RES.	1W 33 ohm		C2017	K22170209	CAP. Chip	CH 50WV 8pF	
					C2018	K22170201	CAP. Chip	CH 50WV 0.5pF	
R2039	J24205103	RES. Chip	1/10W 10k ohm		C2019	K22170235	CAP. Chip	CH 50WV 100pF	
R2040	J24205101	RES. Chip	1/10W 100 ohm		C2020	K22170805	CAP. Chip	B 50WV 0.001uF	
R2041	J24205103	RES. Chip	1/10W 10k ohm		C2021	K22170805	CAP. Chip	B 50WV 0.001uF	
R2042	J24205473	RES. Chip	1/10W 47k ohm		C2022	K22170201	CAP. Chip	CH 50WV 0.5pF	
R2043	J24205473	RES. Chip	1/10W 47k ohm		C2023	K22170235	CAP. Chip	CH 50WV 100pF	
R2044	J24205473	RES. Chip	1/10W 47k ohm		C2024	K22170817	CAP. Chip	B 50WV 0.01uF	
R2045	J24205104	RES. Chip	1/10W 100k ohm		C2025	K22170211	CAP. Chip	CH 50WV 10pF	
R2046	J24205103	RES. Chip	1/10W 10k ohm		C2026	K22170817	CAP. Chip	B 50WV 0.01uF	
R2047	J24205223	RES. Chip	1/10W 22k ohm		C2027	K22170219	CAP. Chip	CH 50WV 22pF	
R2048	J24205473	RES. Chip	1/10W 47k ohm		C2028	K22170210	CAP. Chip	CH 50WV 9pF	
R2049	J24205474	RES. Chip	1/10W 470k ohm		C2029	K22170817	CAP. Chip	B 50WV 0.01uF	
R2050	J24205221	RES. Chip	1/10W 220 ohm		C2030	K22170817	CAP. Chip	B 50WV 0.01uF	
R2051	J24205681	RES. Chip	1/10W 680 ohm		C2031	K22170805	CAP. Chip	B 50WV 0.001uF	
R2052	J24205102	RES. Chip	1/10W 1k ohm		C2032	K22170817	CAP. Chip	B 50WV 0.01uF	
R2053	J24205101	RES. Chip	1/10W 100 ohm		C2033	K22170817	CAP. Chip	B 50WV 0.01uF	
R2054	J24205222	RES. Chip	1/10W 2.2k ohm		C2034	K22170209	CAP. Chip	CH 50WV 8pF	
R2055	J02225471	Carbon Film RES.	1/6W 470 ohm	UJ	C2035	K22170817	CAP. Chip	B 50WV 0.01uF	
R2056	J24205560	RES. Chip	1/10W 56 ohm		C2036	K22170817	CAP. Chip	B 50WV 0.01uF	
R2057	J24205473	RES. Chip	1/10W 47k ohm		C2037	K22170817	CAP. Chip	B 50WV 0.01uF	
R2058	J24205470	RES. Chip	1/10W 47 ohm		C2038	K22170213	CAP. Chip	CH 50WV 12pF	
R2059	J24205332	RES. Chip	1/10W 3.3k ohm		C2039	K22170211	CAP. Chip	CH 50WV 10pF	
R2060	J24205103	RES. Chip	1/10W 10k ohm		C2040	K22170202	CAP. Chip	CH 50WV 1pF	
R2061	J24205103	RES. Chip	1/10W 10k ohm		C2041	K22170211	CAP. Chip	CH 50WV 10pF	
R2062	J24205100	RES. Chip	1/10W 10 ohm		C2042	K22170218	CAP. Chip	CH 50WV 22pF	
R2063	J24205390	RES. Chip	1/10W 39 ohm		C2043	K22170817	CAP. Chip	CH 50WV 9pF	
R2064	J24205331	RES. Chip	1/10W 330 ohm		C2044	K22170817	CAP. Chip	B 50WV 0.01uF	
R2065	J02225560	Carbon Film RES.	1/6W 56 ohm	UJ	C2045	K22170817	CAP. Chip	B 50WV 0.01uF	
R2066	J24205101	RES. Chip	1/10W 100 ohm		C2046	K22170817	CAP. Chip	B 50WV 0.01uF	
R2067	J24205471	RES. Chip	1/10W 470 ohm		C2047	K22170817	CAP. Chip	B 50WV 0.01uF	
R2068	J24205221	RES. Chip	1/10W 220 ohm		C2048	K22170817	CAP. Chip	B 50WV 0.01uF	
R2069	J24205479	RES. Chip	1/10W 4.7 ohm		C2049	K40129004	AL. Electro. CAP.	16WV 10uF	
R2070	J24205474	RES. Chip	1/10W 470k ohm						
R2071	J24205474	RES. Chip	1/10W 470k ohm		C2050	K22170817	CAP. Chip	B 50WV 0.01uF	
R2072	J24205473	RES. Chip	1/10W 47k ohm		C2051	K22170817	CAP. Chip	B 50WV 0.01uF	
R2074	J24205102	RES. Chip	1/10W 1k ohm		C2052	K22170805	CAP. Chip	B 50WV 0.001uF	
R2075	J01225101	Carbon Film RES.	1/6W 100 ohm	PJ	C2053	K22170805	CAP. Chip	B 50WV 0.001uF	
R2076	J24205101	RES. Chip	1/10W 100 ohm		C2054	K22170805	CAP. Chip	B 50WV 0.001uF	
R2077	J24205680	RES. Chip	1/10W 68 ohm		C2055	K22170805	CAP. Chip	B 50WV 0.001uF	
R2078	J24205330	RES. Chip	1/10W 33 ohm		C2056	K22170805	CAP. Chip	B 50WV 0.001uF	
R2079	J24205181	RES. Chip	1/10W 180 ohm		C2057	K22170227	CAP. Chip	CH 50WV 47pF	
R2080	J24205681	RES. Chip	1/10W 680 ohm		C2058	K22170227	CAP. Chip	CH 50WV 47pF	
R2081	J24205689	RES. Chip	1/10W 6.8 ohm		C2059	K22170805	CAP. Chip	B 50WV 0.001uF	
R2082	J24205681	RES. Chip	1/10W 680 ohm		C2060	K22170817	CAP. Chip	B 50WV 0.01uF	
R2083	J24205331	RES. Chip	1/10W 330 ohm		C2061	K22170817	CAP. Chip	B 50WV 0.01uF	
R2084	J24205272	RES. Chip	1/10W 2.7k ohm		C2062	K22170208	CAP. Chip	CH 50WV 7pF	
R2085	J24205101	RES. Chip	1/10W 100 ohm		C2063	K22170817	CAP. Chip	B 50WV 0.01uF	
R2086	J24205222	RES. Chip	1/10W 2.2k ohm		C2064	K22170817	CAP. Chip	B 50WV 0.01uF	
R2087	J24205471	RES. Chip	1/10W 470 ohm		C2065	K22170213	CAP. Chip	CH 50WV 12pF	
R2088	J24205103	RES. Chip	1/10W 10k ohm		C2066	K22170805	CAP. Chip	B 50WV 0.001uF	
R2089	J24205151	RES. Chip	1/10W 150 ohm		C2067	K22170207	CAP. Chip	CH 50WV 6pF	
R2090	J20306221	Metalic Film RES.	1W 220 ohm		C2068	K22170817	CAP. Chip	B 50WV 0.01uF	
					C2069	K22170817	CAP. Chip	B 50WV 0.01uF	
R2091	J24205103	RES. Chip	1/10W 10k ohm		C2070	K22170817	CAP. Chip	B 50WV 0.01uF	
R2092	J24205102	RES. Chip	1/10W 1k ohm		C2071	K22170817	CAP. Chip	B 50WV 0.01uF	
R2093	J24205689	RES. Chip	1/10W 6.8 ohm		C2072	K22170817	CAP. Chip	B 50WV 0.01uF	
R2094	J24205102	RES. Chip	1/10W 1k ohm		C2073	K22170817	CAP. Chip	B 50WV 0.01uF	

(FEX-736-1.2) PARTS LIST

C3026	K21170002	Feed Through CAP.		50WV	0.001uF
C3027	K22170201	CAP. Chip	CH	50WV	0.5pF
C3028	K22170201	CAP. Chip	CH	50WV	0.5pF
C3029	K02172059	Ceramic CAP.	CK	50WV	0.5pF
L3001	L0020678	Coil			
P3001	P1090209	Connector			
JP3001	T9205537	Wire ASSY			
RL3001	M1190042	Relay	G4Y-15ZP		
	L9190001	Ferrite Beads			
	Q5000036	TP-G	MK-1095		
	T9317823	Wire ASSY			
	T9317800A	Wire ASSY			
	T9317822	Wire ASSY			
	R4083840B	Booster Heatsink			
	R0511080A	Shield Cover PA			
	R0124500	Shield Plate PA			
	R7043900	Insulator Board B			



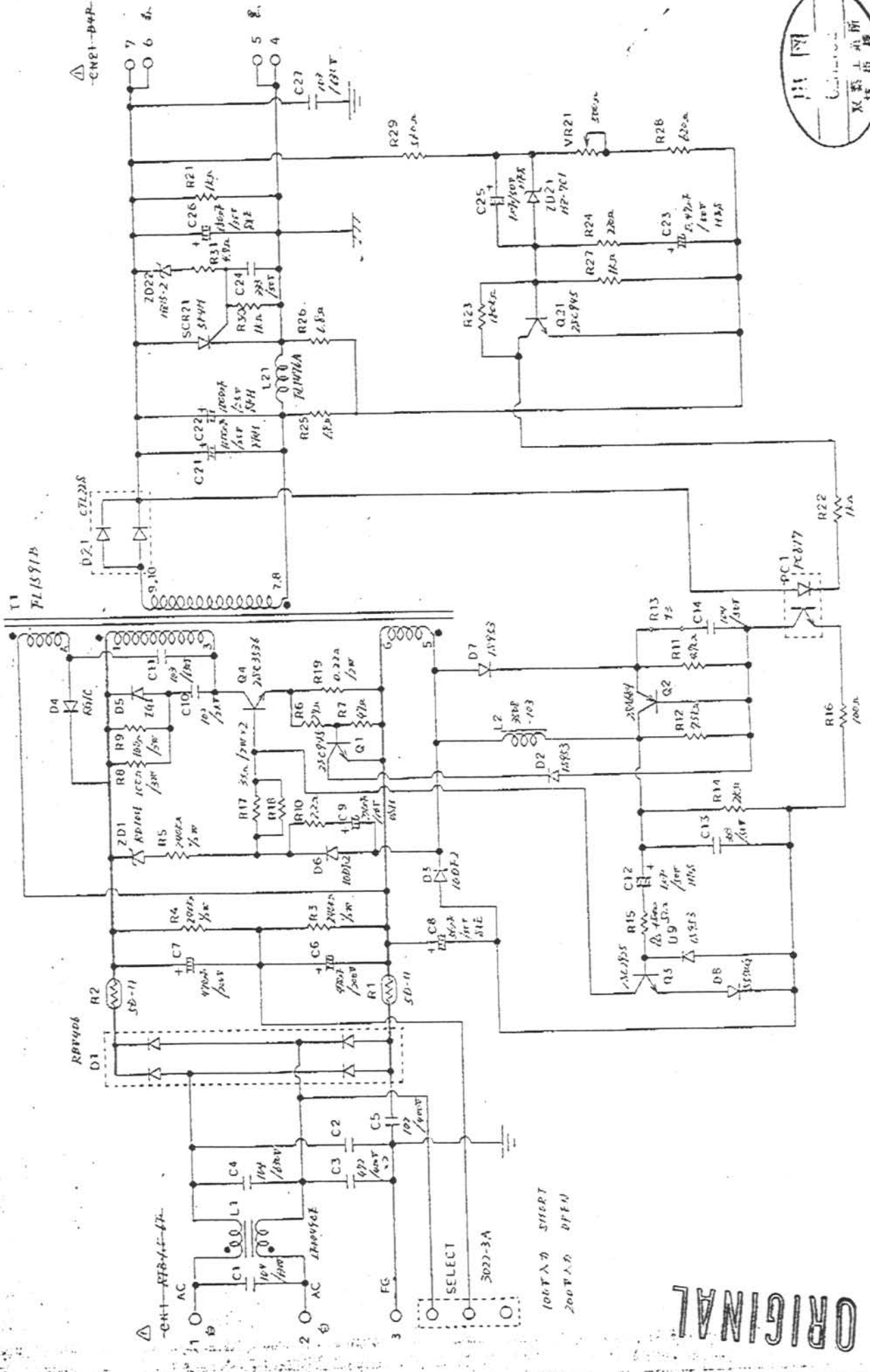
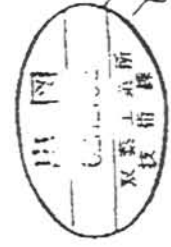

ORIGINAL

DIMENSIONS:		TYPE (CHANGED)		DATE		DRAWN		CHECKED		RELEASED		SCALE		DATE	
HW (MATERIAL)	12.9.3	12.9.3	12.9.3	12.9.3	12.9.3	12.9.3	12.9.3	12.9.3	12.9.3	12.9.3	12.9.3	12.9.3	12.9.3	12.9.3	12.9.3
HW (TREATMENT)	12.9.3	12.9.3	12.9.3	12.9.3	12.9.3	12.9.3	12.9.3	12.9.3	12.9.3	12.9.3	12.9.3	12.9.3	12.9.3	12.9.3	12.9.3
TITLE: 回路图 APPLICATIONS: 1. 四川燕巢股份有限公司 DESIGNED: 张... CHECKED: 李... RELEASED: 王...												SHEET: 1/1 SCALE: 1:1			
PROJECT: FP1274A-003 COMPANY: SICHUAN YANCAO INDUSTRIES CO., LTD.															

ORIGINAL

2/4
⑦

S63-07-21

FT-736R (FP1274A)

FT-736R (FP1274A)

POWER SUPPLY UNIT

F2918000 Printed Circuit Board (FP1274A-051R4)

Q01	G3309450	Transistor	2SC945	
Q02	G3106840	Transistor	2SA684	
Q03	G3329250	Transistor	2SC2925	
Q04	G3335360	Transistor	2SC3536	
Q21	G3309450	Transistor	2SC945	
SCR21	G3090083	Thyristor	5P4M	
PC01	G0090006	Photo Coupler	PC817	
D01	G2090399	Diode	RBV406	
D02	G2009530	Diode	1S953	
D03	G2090400	Diode	10DF2	
D04	G2090401	Diode	RG1C	
D05	G2090402	Diode	EG-1	
D06	G2090400	Diode	10DF2	
D07	G2009530	Diode	1S953	
D08	G2090304	Diode	S5500G	
D09	G2009530	Diode	1S953	
D21	G2090403	Diode	CTL22S	
ZD01	G2090404	Diode	RD100E	
ZD21	G2090405	Diode	HZ7-C1	
ZD22	G2090406	Diode	HZ15-2	
R01	G9090038	Thermistor	5D-11	
R02	G9090038	Thermistor	5D-11	
R03	J00275244	Carbon Film Res.	240k Ohm	1/4W
R04	J00275244	Carbon Film Res.	240k Ohm	1/4W
R05	J00275244	Carbon Film Res.	240k Ohm	1/4W
R06	J00245270	Carbon Film Res.	27 Ohm	1/4W
R07	J00245470	Carbon Film Res.	47 Ohm	1/4W
R08	J20359002	Metallic Film Res.	100 Ohm	3W
R09	J20359002	Metallic Film Res.	100 Ohm	3W
R10	J00245229	Carbon Film Res.	2.2 Ohm	1/4W
R11	J00245472	Carbon Film Res.	47k Ohm	1/4W
R12	J00245752	Carbon Film Res.	7.5k Ohm	1/4W
R14	J00245101	Carbon Film Res.	2k Ohm	1/4W
R15	J00245150	Carbon Film Res.	15 Ohm	1/4W
R16	J00245202	Carbon Film Res.	100 Ohm	1/4W
R17	J20339004	Metallic Film Res.	33 Ohm	2W
R18	J20339004	Metallic Film Res.	33 Ohm	2W
R19	J10335029	Cement Res.	0.22 Ohm	2W

ORIGINAL

FT-736R (FP1274A)

R21	J00245102	Carbon Film Res.	1k Ohm	1/4W
R22	J00245102	Carbon Film Res.	1k Ohm	1/4W
R23	J00245184	Carbon Film Res.	180k Ohm	1/4W
R24	J00245221	Carbon Film Res.	220 Ohm	1/4W
R25	J00245689	Carbon Film Res.	6.8 Ohm	1/4W
R26	J00245689	Carbon Film Res.	6.8 Ohm	1/4W
R27	J00245102	Carbon Film Res.	1k Ohm	1/4W
R28	J00245621	Carbon Film Res.	620 Ohm	1/4W
R29	J00245561	Carbon Film Res.	560 Ohm	1/4W
R30	J00245102	Carbon Film Res.	1k Ohm	1/4W
R31	J00245479	Carbon Film Res.	4.7 Ohm	1/4W

VR21 J51778501 Pot. EVN38CA00B52 500 Ohm

C01	K55280001	Metallized Paper Cap.	0.1uF	630V
C02	K12329002	Ceramic Cap.	0.0047uF	400V
C03	K12329002	Ceramic Cap.	0.0047uF	400V
C04	K55280001	Metallized Paper Cap.	0.1uF	630V
C05	K12269001	Ceramic Cap.	0.001uF	400V
C06	K40239003	Al. Electro Cap.	470uF	200V
C07	K40239003	Al. Electro Cap.	470uF	200V
C08	K40179037	Al. Electro Cap.	56uF	25V
C09	K40129056	Al. Electro Cap.	220uF	16V
C10	K12339002	Ceramic Cap.	0.001uF	2kV
C11	K55280002	Metallized Paper Cap.	0.01uF	630V
C12	K40179038	Al. Electro Cap.	1uF	50V
C13	K50177333	Mylar Film Cap.	0.033uF	50V
C14	K50170028	Mylar Film Cap.	0.1uF	50V
C21	K40149033	Al. Electro Cap.	1000uF	25V
C22	K40149033	Al. Electro Cap.	1000uF	25V
C23	K40179039	Al. Electro Cap.	0.47uF	50V
C24	K50177333	Mylar Film Cap.	0.033uF	50V
C25	K40179038	Al. Electro Cap.	1uF	50V
C26	K40169021	Al. Electro Cap.	680uF	35V
C27	K55280002	Metallized Paper Cap.	0.01uF	630V

T01 L2190025 Converter Transformer FL1591B

L01 L2190026 Noise Filter LF0049CE

L02 L2190027 Choke Coil 3508-103

L21 L2190028 Choke Coil FL1476A

S8000037 Heatsink
 S8000038 Hanger
 S8000031 Transformer Holder
 S8000039 Insulator Sheet



BAND MODULE INSTALLATION IN THE FT-736R

The FT-736R is supplied with the 144 MHz and 430 MHz band modules already installed in the two upper compartments. Up to two additional band modules may also be installed, in the lower compartments.

Note in the following diagram that the 1.2 GHz module may be installed only in the lower left corner (when viewed from the rear). The 50 and 220 MHz modules may be installed in either of the lower compartments.

- (1) Remove all connections from the jacks on the rear panel, and then remove the two screws in the carrying handle and the eight screws affixing the top and bottom covers. Remove the handle and covers, and place the transceiver upside-down on the workbench.
- (2) Locate the gray rubber thermal pad supplied with the Band Module, and the four machine screws. After confirming the correct location for the Module, insert the machine screws from the rear through the four holes in the heatsink and then through the holes in the thermal sheet.
- (3) Carefully slide the Band Module into place so that the mounting feet on the Module fit into their slots in the chassis.

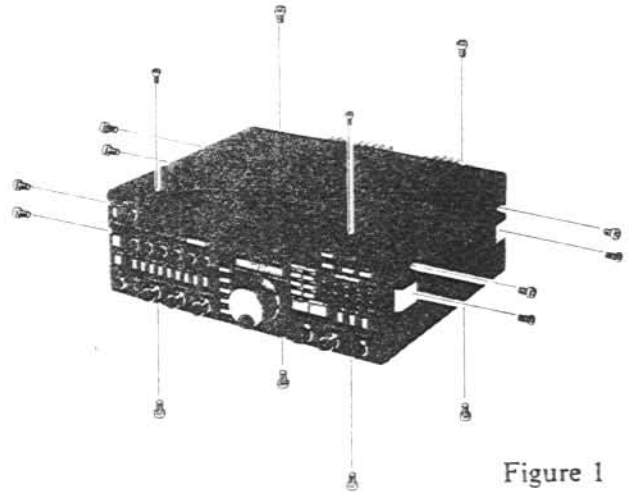

Figure 1

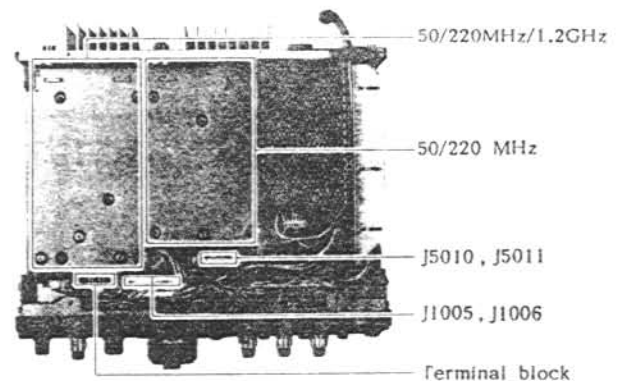

Figure 2

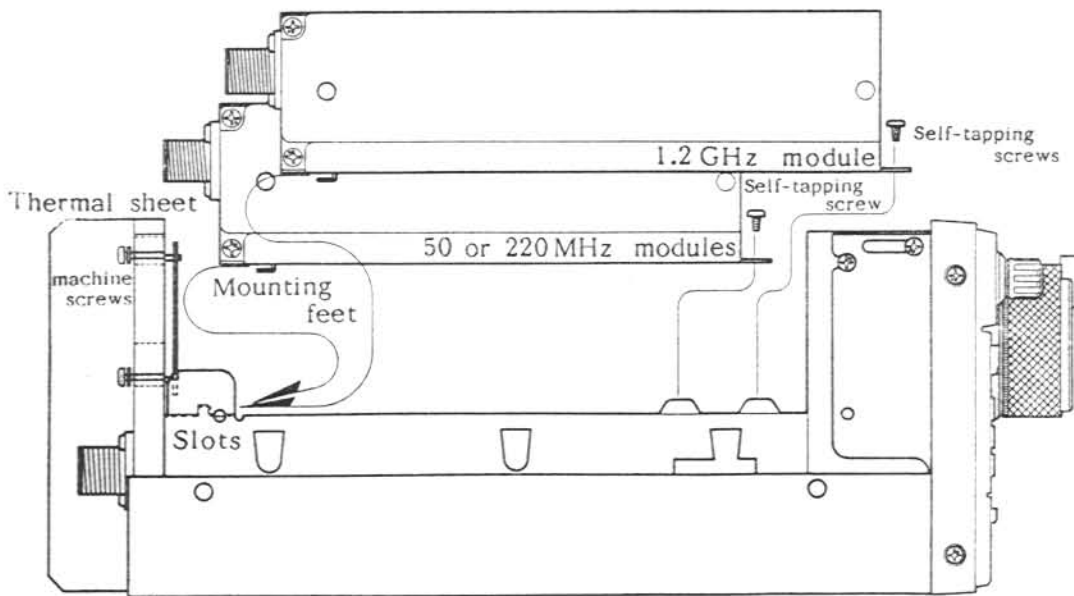

Figure 3

- (4) Tighten the four machine screws, and install one self-tapping screw (for 50 or 220 MHz modules: two for the 1.2 GHz module) through the hole(s) near the front of the module into the chassis.
- (5) Loosen the two front panel mounting screws on each side, and fold the front panel upwards.
- (6) Connect the single red wire to either of the terminals on the terminal block.
- (7) Install the 13-pin plug into J5010 or J5011, and the 10-pin plug into J1005 or J1006. Make a note of which band modules are connected to J5010 and J5011. You will need this information when connecting a masthead preamp or an external power amplifier.
- (8) Fold the front panel back into place, tighten its screws, and replace the covers and carrying handle.

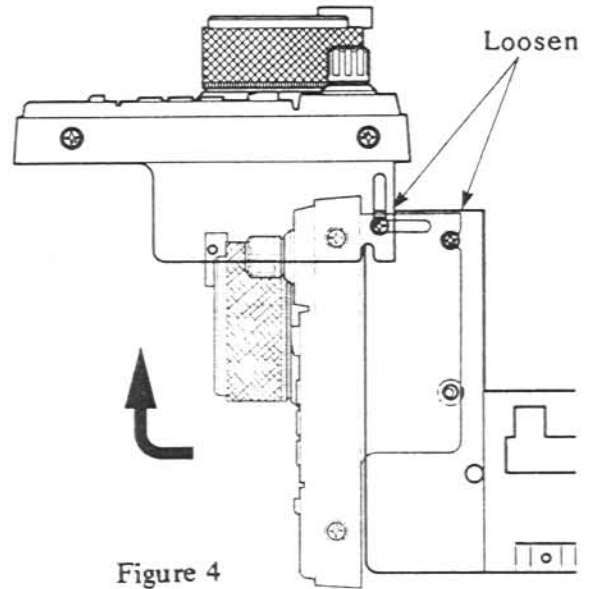

Figure 4

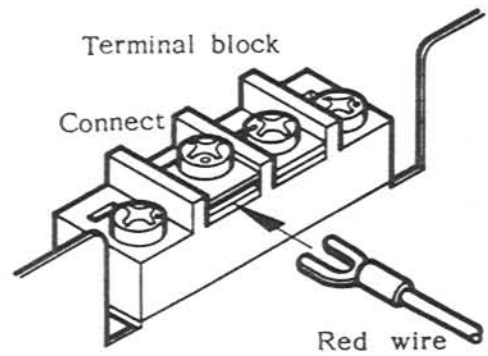

Figure 5

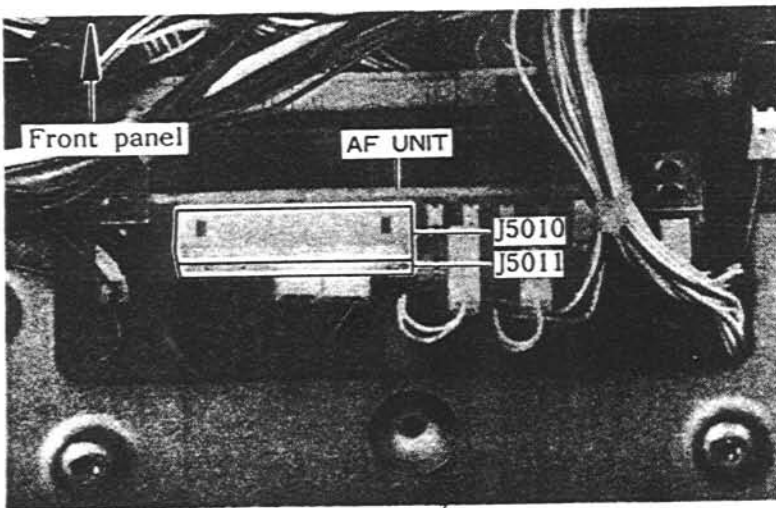

Figure 6

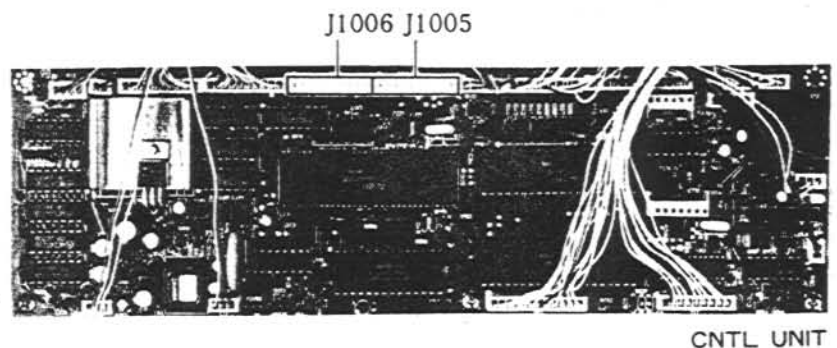

Figure 7

CNTL UNIT

KEYER UNIT INSTALLATION IN THE FT-736R

- (1) Remove the eight screws affixing the top cover, and remove the cover.
- (2) Locate 8-pin connector P4001 on the TX Unit.

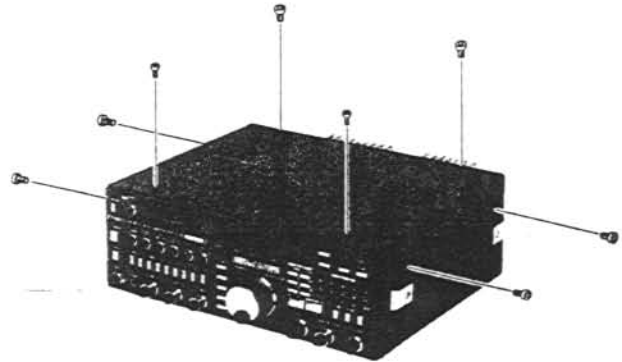

Figure 1

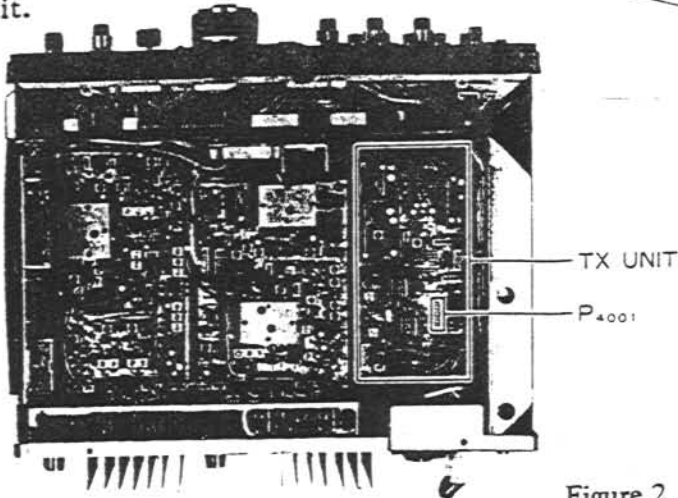

Figure 2

- (3) Cut the twisted jumper wire near P4001.

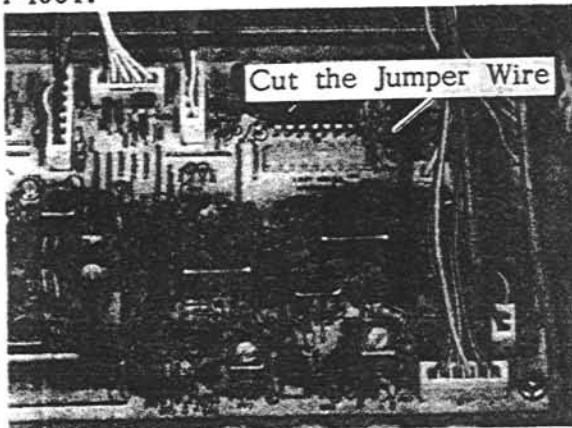
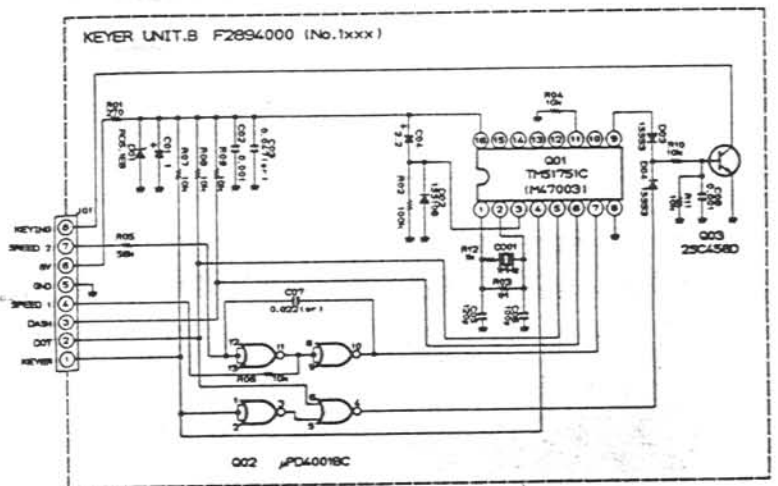
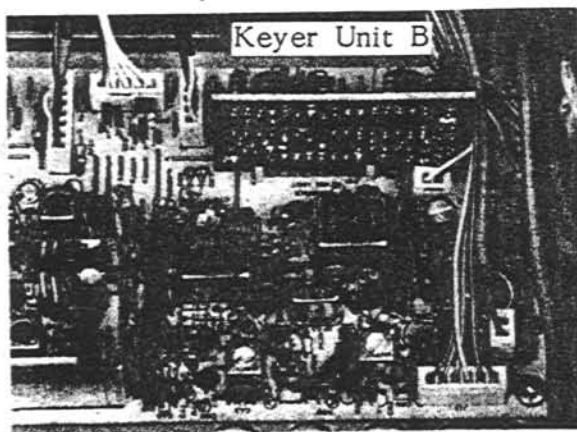

Figure 3

- (4) Insert the Keyer Unit into P4001.



RESISTOR VALUES ARE IN Ω , $\text{k}\Omega$, $\text{M}\Omega$!
CAPACITOR VALUES ARE IN μF .
UNLESS OTHERWISE NOTED.
 $\text{1}\mu\text{F}$ CAPACITORS ARE 50VDC-VOLTAJE GRAMIC 25V!

Figure 4

- (5) Replace the top cover and its eight screws.



YAESU MUSEN CO., LTD.
C.P.O. BOX 1500
TOKYO, JAPAN

Installing Internal Accessories

XF-455MC CW Narrow Filter

FT-736R

(1) Remove all interconnections from the rear panel, and then remove the two screws in the carrying handle and eight screws affixing the covers. Remove the handle and covers, and place the transceiver left side up on the workbench.

(2) Remove the six screws affixing the RX IF Unit at the left side of the chassis, and carefully fold the board away to allow access to the solder side.

(3) Insert the four filter leads into their holes, and solder them into place (polarity is not important).

(4) Move the jumper plug indicated below from the WI[de] to the NA[rrow] pins.

(5) Replace the RX IF Unit and its six screws (using care not to pinch any wires). If installing other options, proceed to the next paragraph. Otherwise, replace the covers and carrying handle, and their screws.

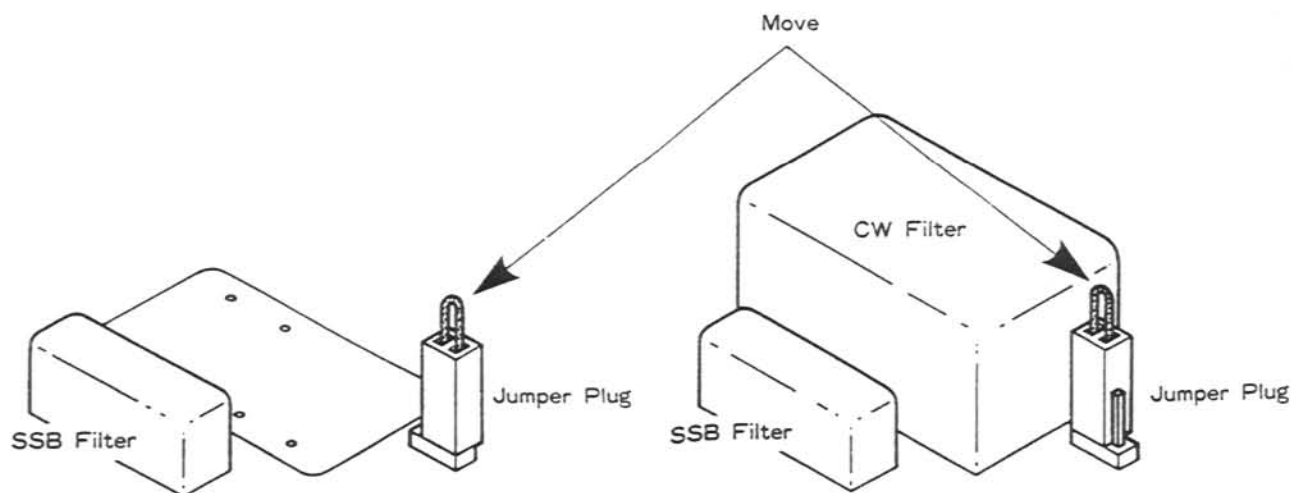
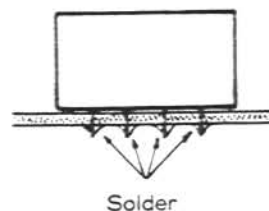
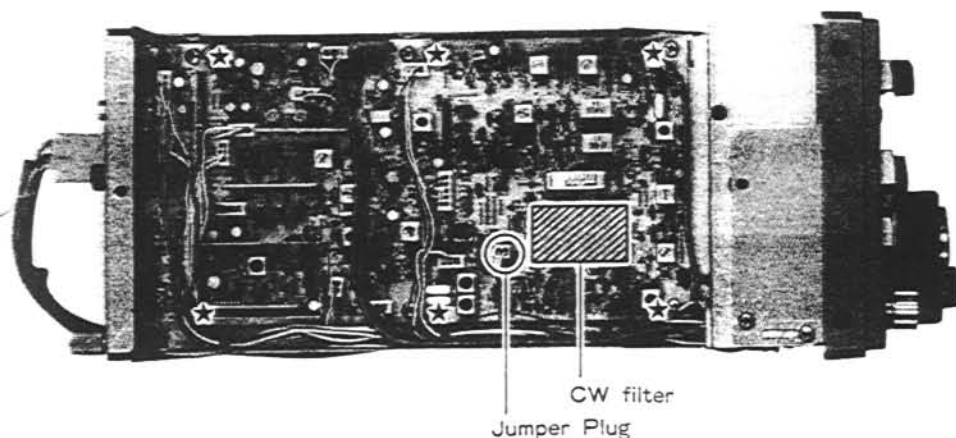
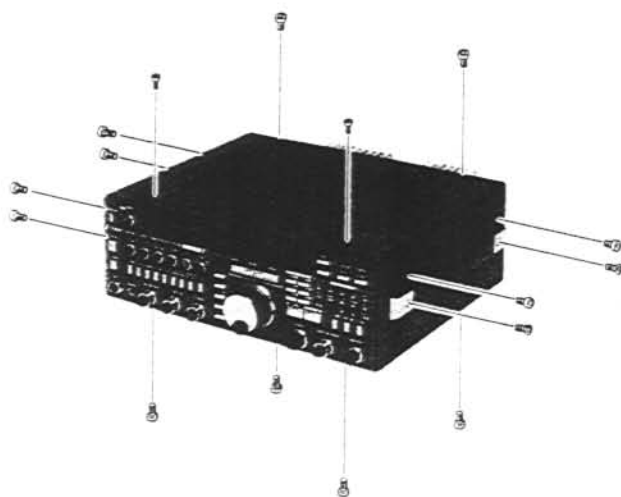

FVS-1 VOICE SYNTHESIZER INSTALLATION IN THE FT-736R

- (1) Remove all connections from the jacks on the rear panel, and then remove the two screws in the carrying handle and the eight screws affixing the top and bottom covers. Remove the handle and covers.
- (2) Loosen the two front panel mounting screws on each side, and fold the front panel down.
- (3) On the inside of the front panel behind the keypad, locate the unconnected 10-pin jack, and connect the FVS-1 here.

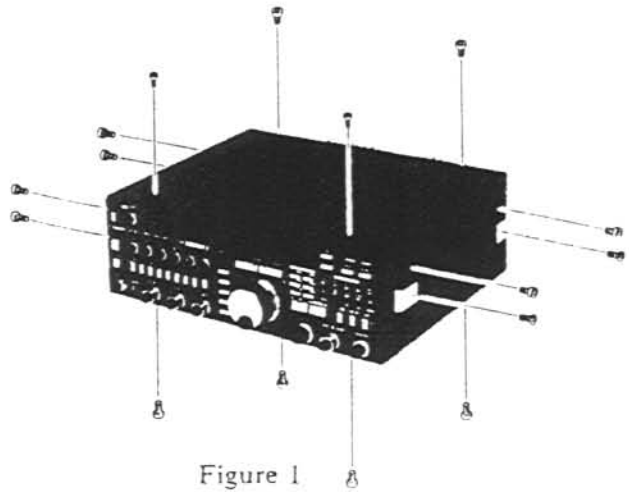
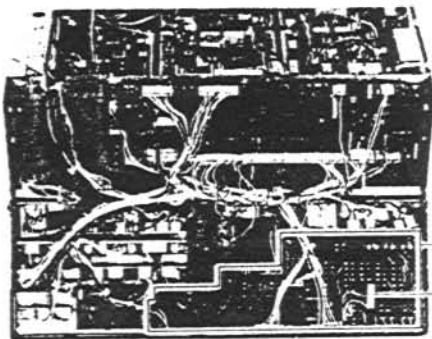

Figure 1



DISPLAY UNIT

10-pin jack

Figure 3

- (4) Set the JA[panese]/EN[glis]h switch on the FVS-1 to the desired position, and then affix the FVS-1 board into place using the double-sided adhesive tape on the flat surface of the FVS-1 IC.

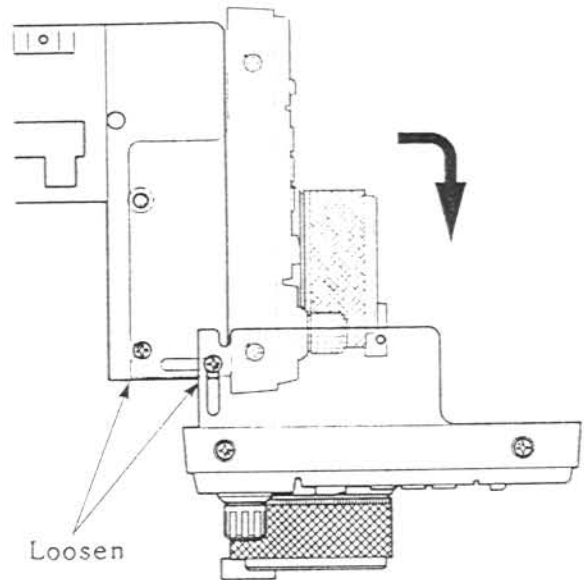

Loosen

Figure 2

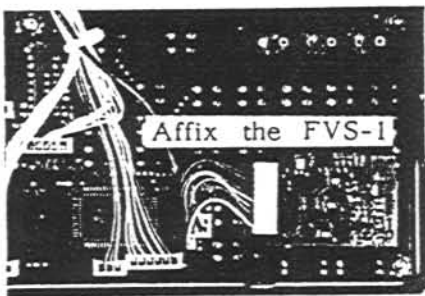
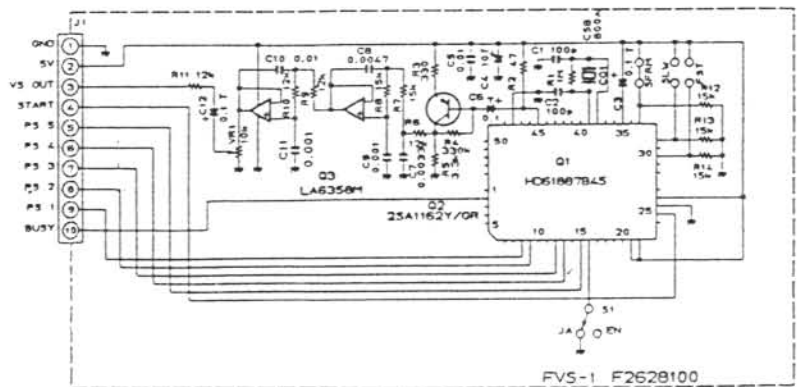

Figure 4



- (5) Fold the front panel back into place, tighten its screws, and replace the covers and carrying handle.



YAESU MUSEN CO., LTD.
C.P.O. BOX 1500
TOKYO, JAPAN

YAESU TV-736 ATV MODULATOR/DEMODULATOR

The TV-736 is a fast-scan television modulator/demodulator designed for use with the FT-736R Transceiver equipped with the optional 1.2 GHz Band Module. Black and white or color Amateur Television (ATV) reception is provided when an external video monitor is connected to the TV-736, and transmission is possible when an external video camera is connected. Double side-band (A3F) mode can be used either alone or with an FM audio subcarrier (F3E, selected by an internal jumper).

Emission Mode Selection

The TV-736 is set for the video+audio mode at the factory. For color transmission, this requires a total bandwidth of 9 MHz. If you want or need to transmit video without the FM subcarrier, remove the bottom panel (see "Bottom Panel Removal" on page 3) and connect the two halves of the (cut) jumper wire near T14 (shown below). Keep the bottom cover off for now.

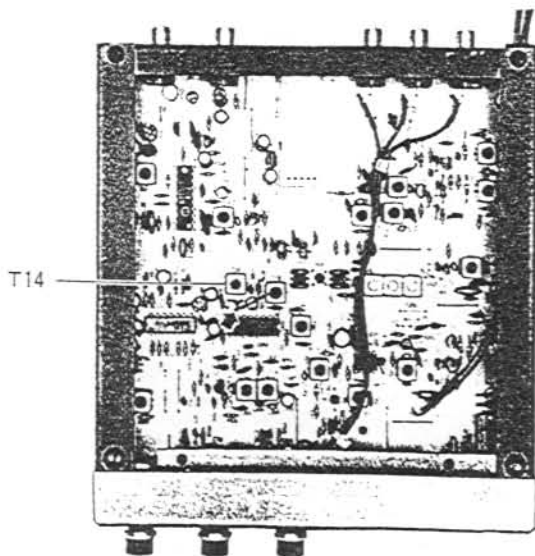

Mode Select Jumper Location

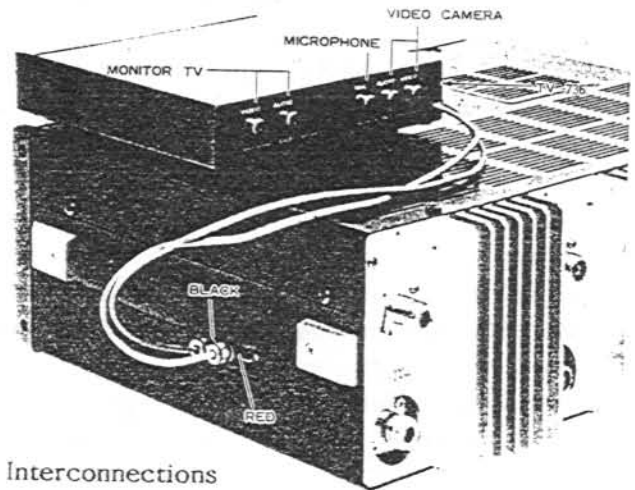

Interconnections

Connect the two cables from the TV-736 to the FT-736R as shown above: the red plug connects nearest the rear of the transceiver.

If you have a video monitor or a TV with a baseband (composite) video input jack, connect the TV-736 VIDEO OUT jack to the monitor's video input jack using 75-ohm coaxial cable (peak video level is 1 Vp-p @75 ohms). If your TV has no video input jack, you will need to install a video modulator (not supplied by Yaesu) between the TV-736 and the TV's antenna jack.

Connect your camera's video output line to the TV-736 VIDEO IN jack. Camera output level should be 1 Vp-p @75 ohms impedance.

For audio subcarrier operation, connect your camera's audio output line to the TV-736 AUDIO IN jack. Audio output from the camera should be 500mV peak @600 ohms impedance. Also, connect TV-736 AUDIO OUT jack to the audio input of your monitor, or to an external audio amplifier. Audio output level is also 500mV peak @600 ohms.

If your camera does not have a microphone, or if you wish to connect another microphone (200 to 10k ohms), connect it to the MIC jack on the rear of the TV-736.

Operation

Before operating the TV-736 for the first time, the bottom cover must be removed to allow access to video input level trimmer VR04. See "Bottom Panel Removal".

After selecting the mode of emission (video-only, or with audio) by the jumper described previously, and connecting your camera and monitor, switch on the transceiver and the TV-736 POWER switch.

Set the FT-736R to the 1.2 GHz band, and select either the FM or an SSB mode (operation is the same in these mode). Set the METER selector knob to the S/PO position.

With your camera still turned off, press the MOX button to transmit a carrier, and adjust the RF POWER control on the TV-736 so that the FT-736R meter deflects to "8" on the PO scale.

Now (while still transmitting) switch on the camera and adjust VR04 inside the bottom panel (see photo at right) for the desired contrast on the monitor.

The AUDIO control on the front panel of the TV-736 adjusts the audio level from the camera, if your camera includes a microphone and if it is connected to the AUDIO IN jack on the TV-736. The MIC control adjusts the audio level if a microphone is connected to the MIC jack on the TV-736.

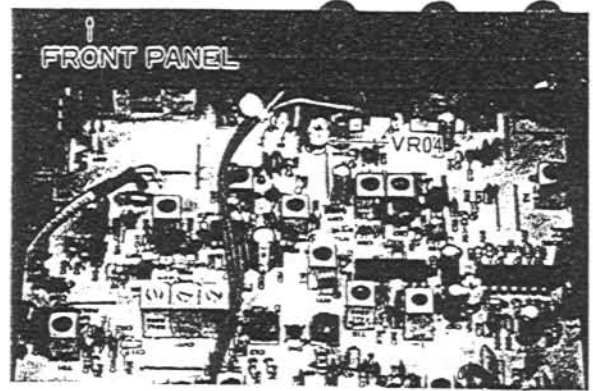

Video Input Level Adjustment

To receive, press the MOX button on the transceiver so that it returns to the undepressed position. Adjust the RF GAIN control, as necessary, for best picture.

NOTE: the DRIVE and MIC gain controls on the FT-736R are disabled when the TV-736 is operating. Just turn off the TV-736 POWER switch to operate the transceiver in other modes.

Bottom Panel Removal

The bottom panel of the TV-736 is secured by two plastic rivets at the front ("A" in the photo on the next page), and two screws ("B"). Pull the rivet pins all the way out to release them, and then remove the two screws. Replace the bottom panel after adjusting VR04 to obtain proper contrast with your camera.

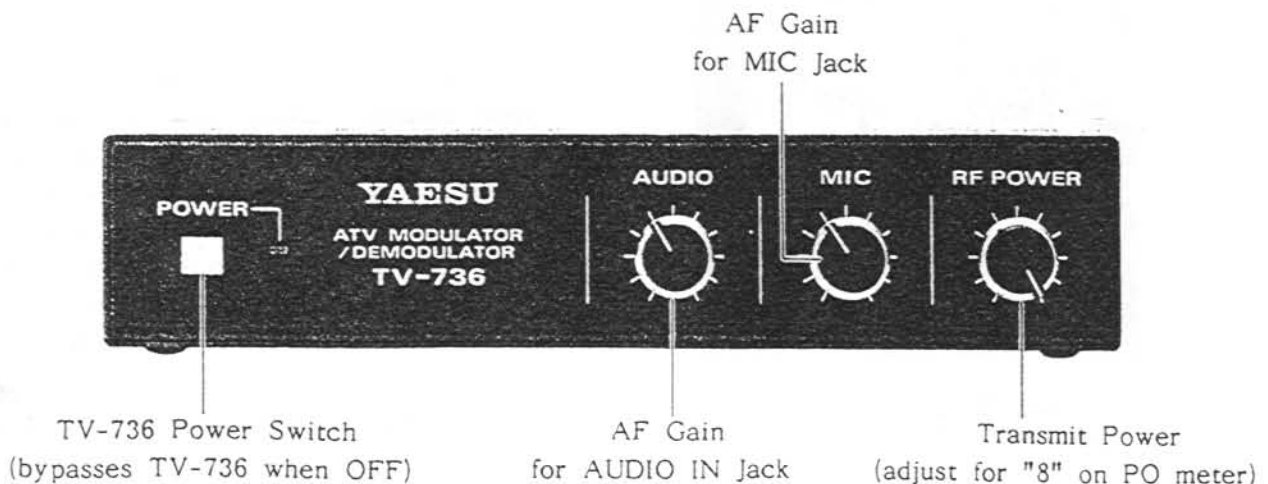

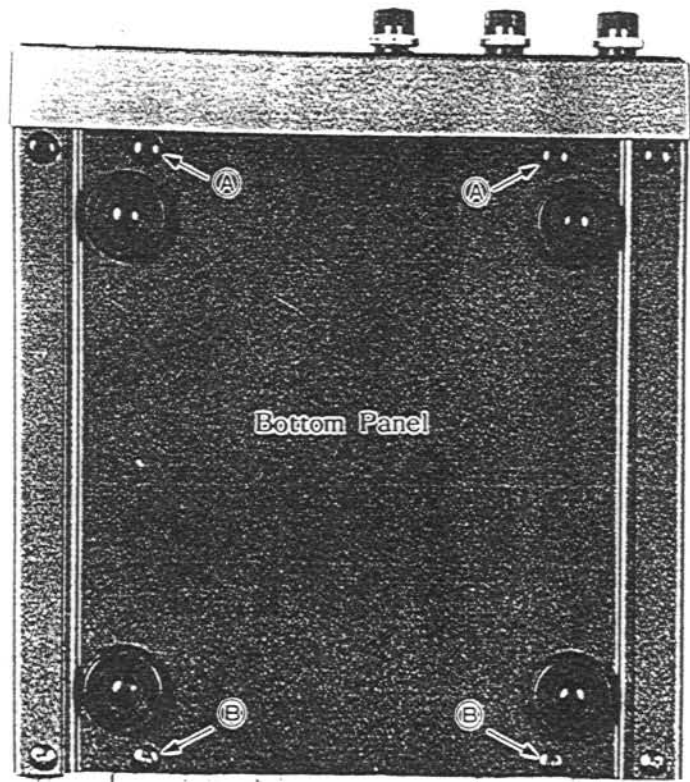
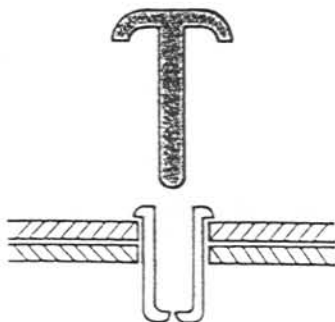
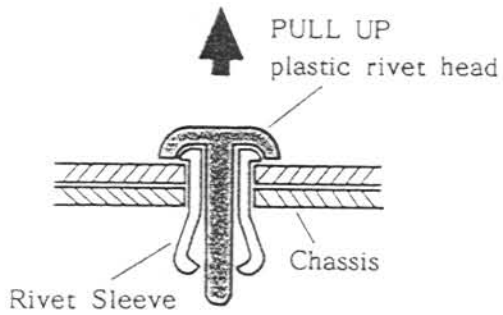
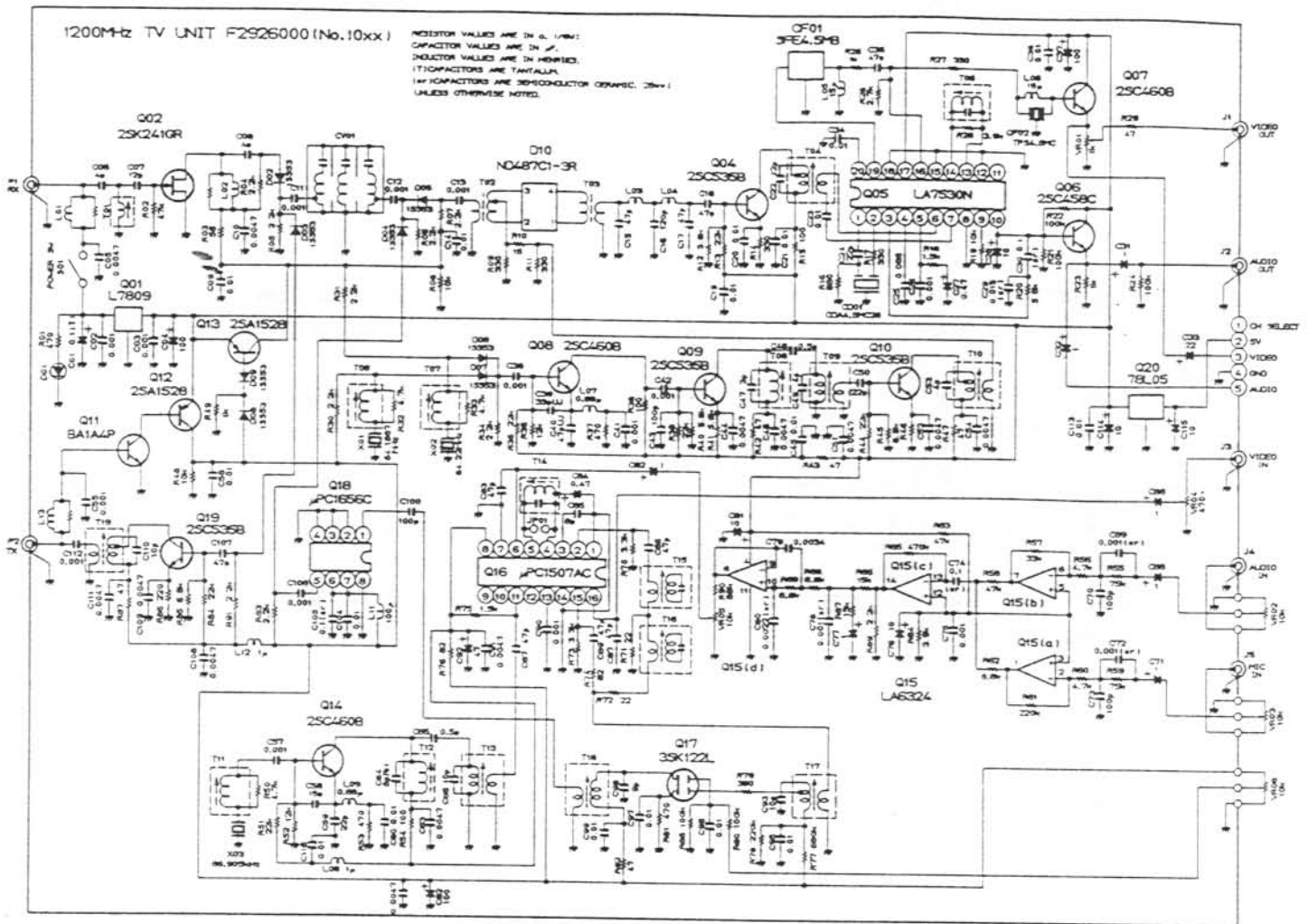

SPECIFICATIONS

Operating frequency range:

1240-1300 MHz (w/FT-736R & FEX-736-1.2)

Modes of emission:

A3F, or A3F+F3E

Transmitter modulation method:

Amplitude Modulation

Video carrier output frequency (IF):

133.810 MHz

Audio carrier output frequency (IF):

138.310 MHz

Video and audio carrier stability:

±10ppm

Maximum audio (FM) deviation:

±25 kHz

Maximum total bandwidth:

9 MHz

Spurious emissions:

less than -50dB

Peak video input level:

1 Vp-p @75 ohms (typical)

Peak audio input level:

500 mVrms @600 ohms (typical)

Peak video output level:

1 Vp-p @75 ohms (typical)

Peak audio output level:

500 mVrms @600 ohms (typical)

Operating voltage:

13.8 VDC (from FEX-736-1.2 module)

Operating temperature range:

0 to +40°C

Size (WHD):

167 x 35 x 170.5mm

Weight: 800 grams



YAESU MUSEN CO., LTD.

C.P.O. BOX 1500

TOKYO, JAPAN

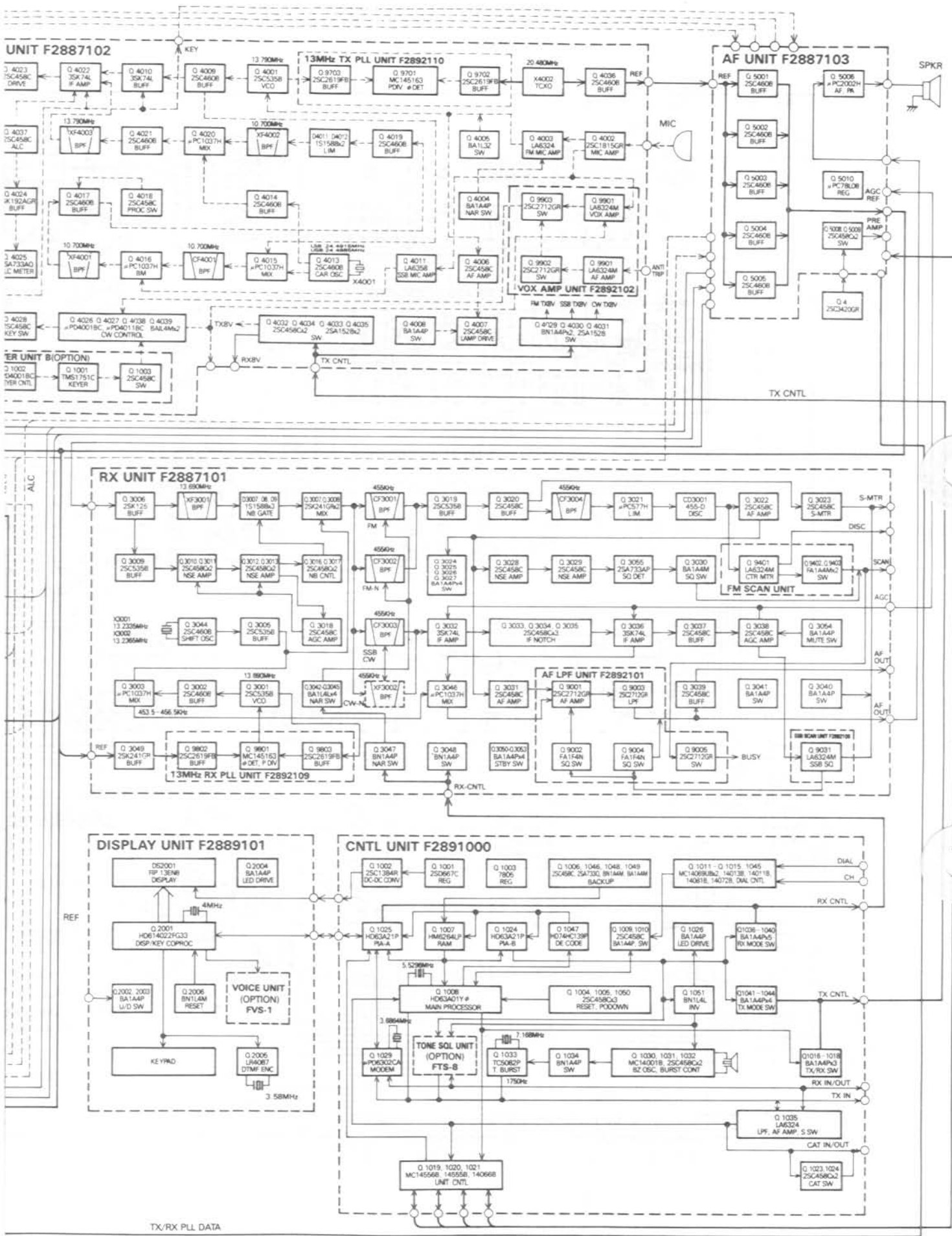

FT-736R
BLOCK DIAGRAM

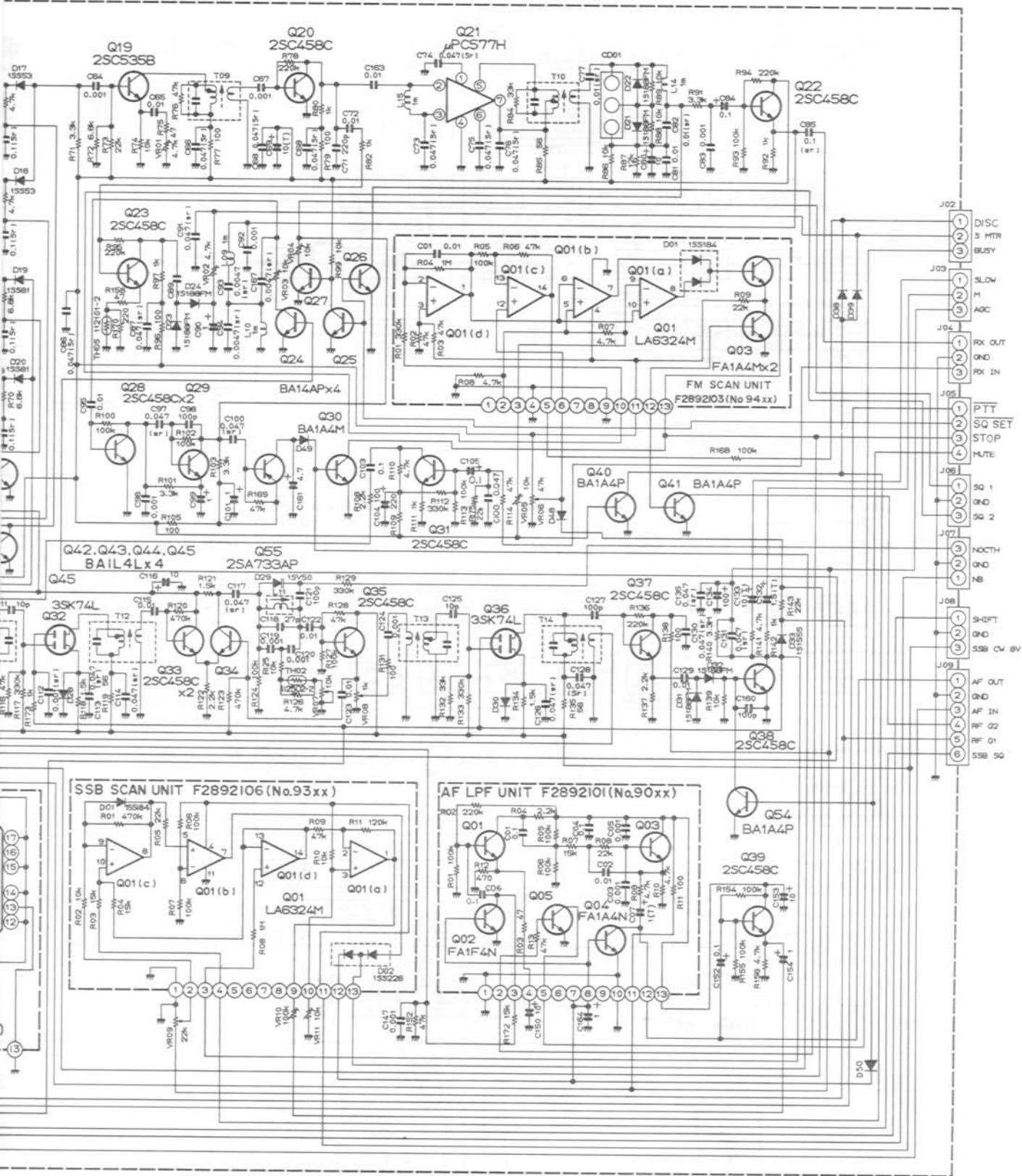

TX/RX PLL DATA

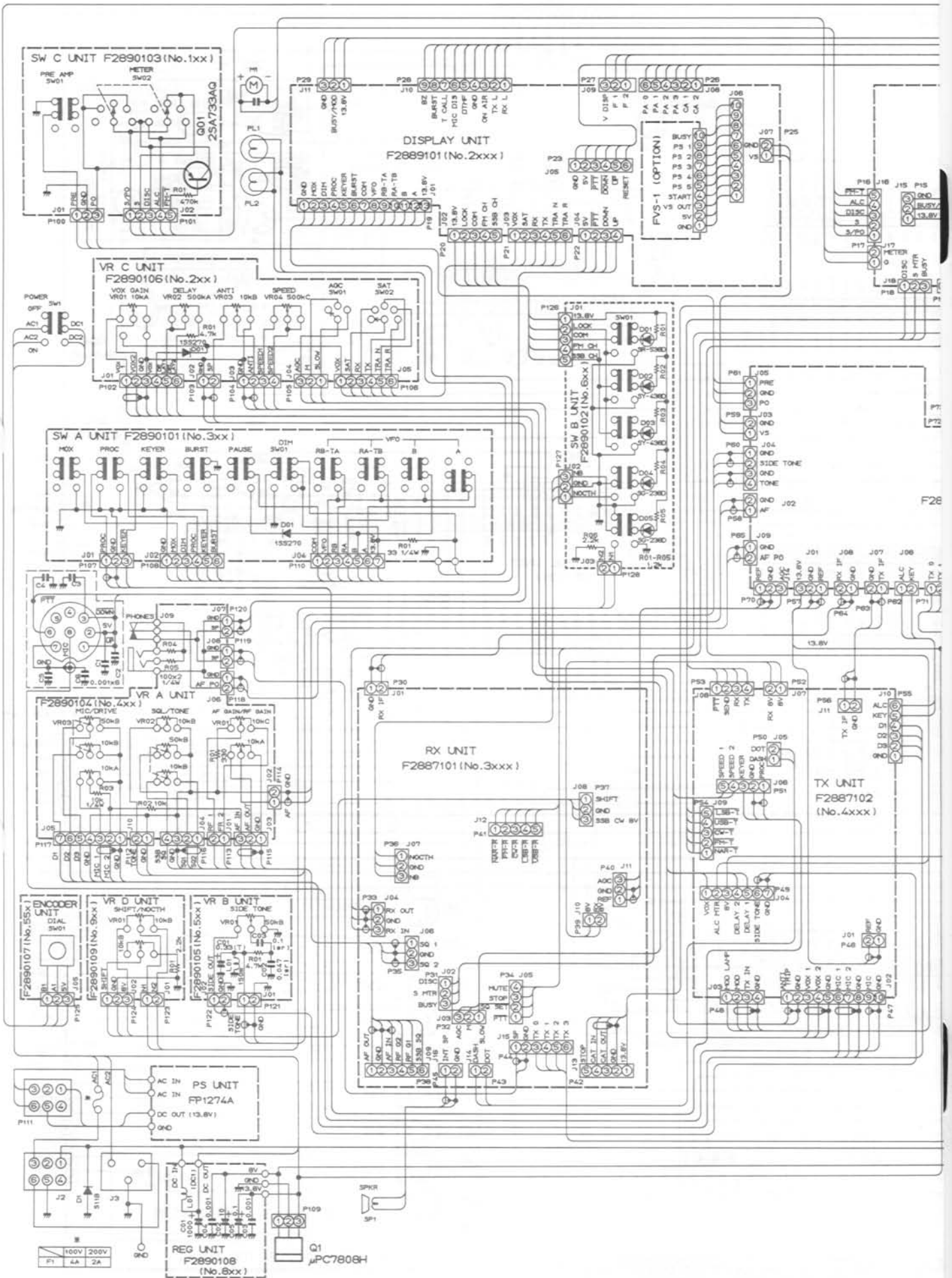

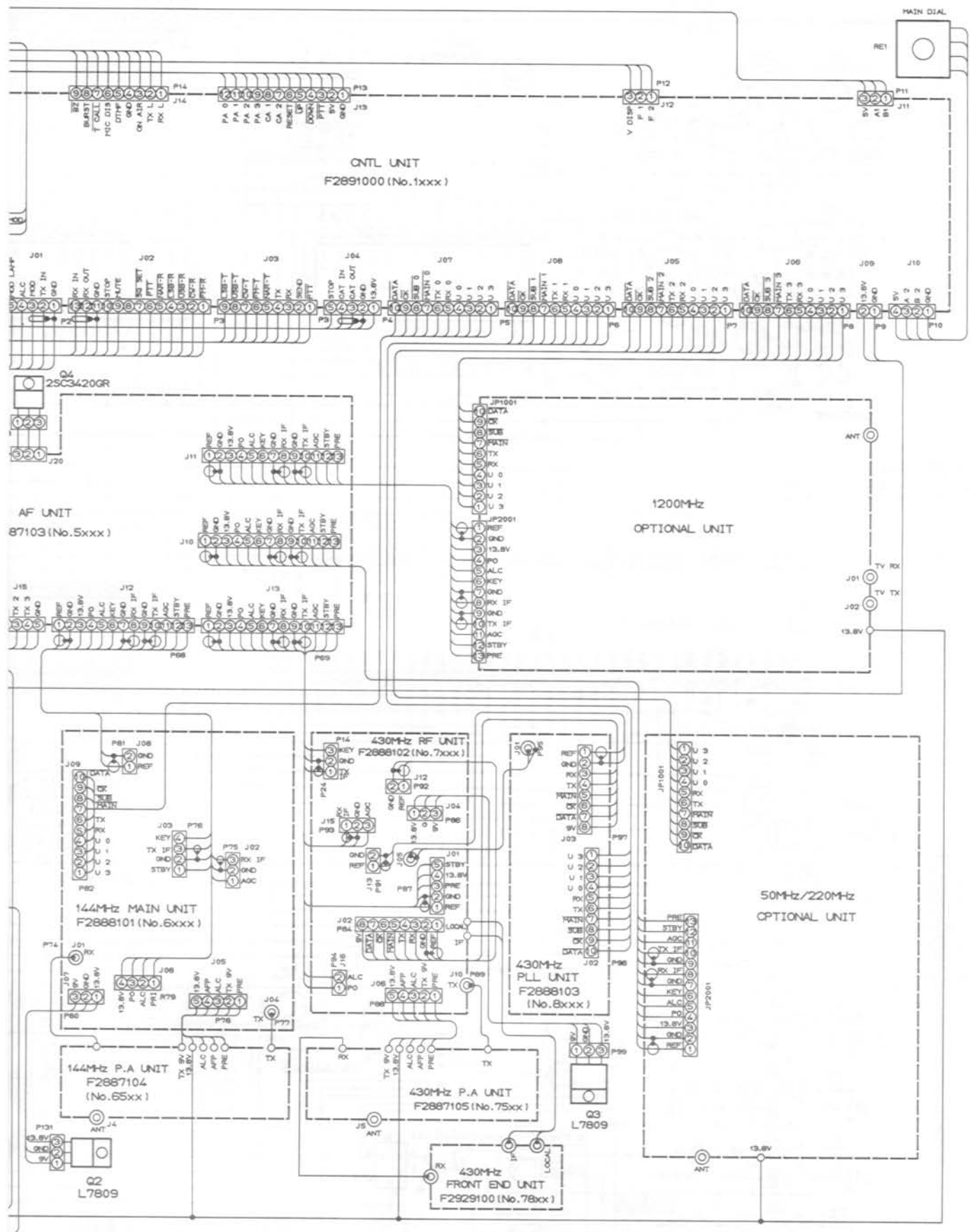

RESISTOR VALUES ARE IN Ω , $\frac{1}{2}W$;
 CAPACITOR VALUES ARE IN μF .
 (T) CAPACITORS ARE TANTALUM.
 (S) CAPACITORS ARE SEMICONDUCTOR CERAMIC, 25V, UNLESS OTHERWISE NOTED.

FT-736
 CONNECTION DIAGRAM

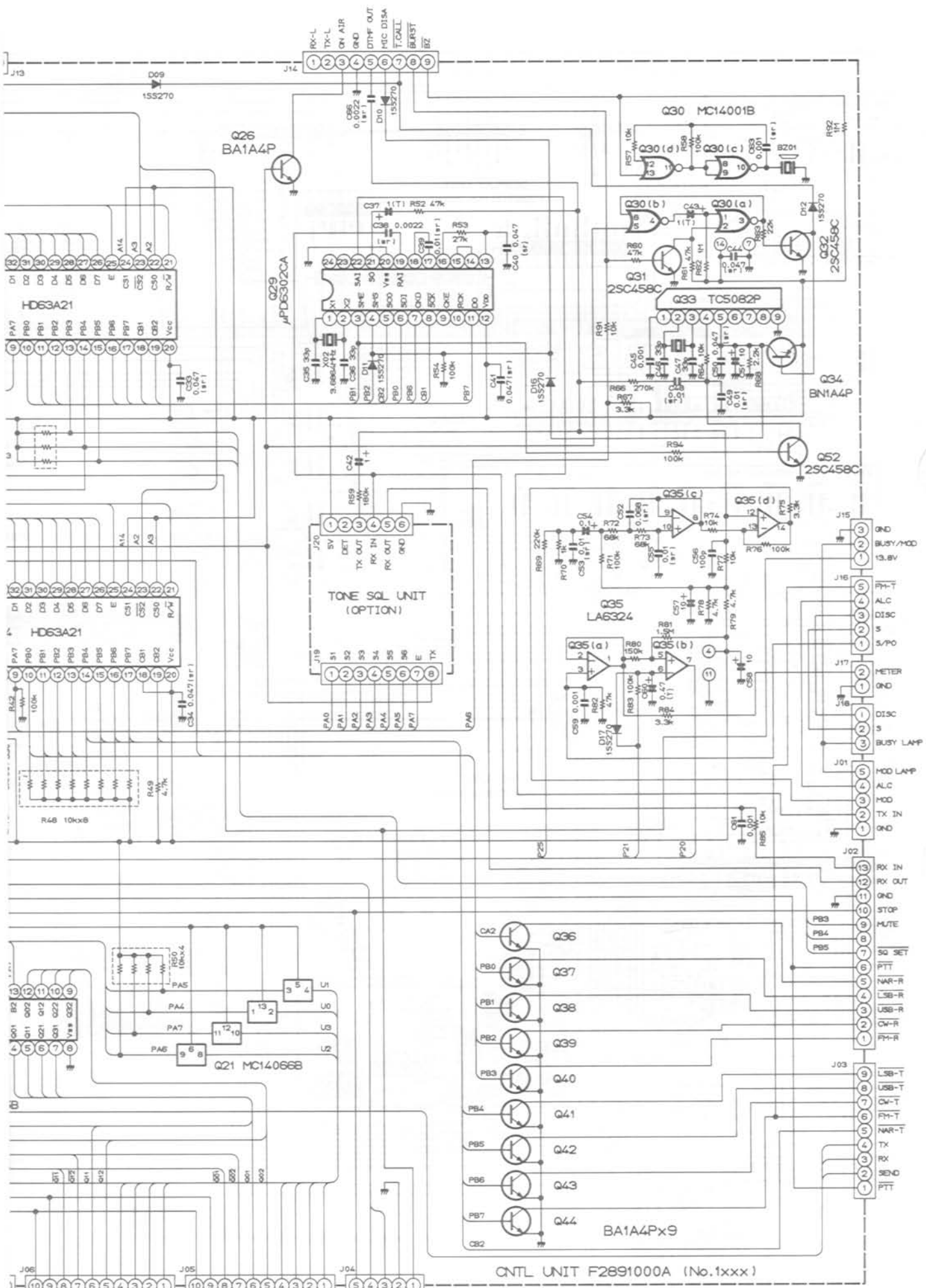

RESISTOR VALUES ARE IN Ω, 1/10W;
 CAPACITOR VALUES ARE IN μF.
 (T) CAPACITORS ARE TANTALUM.
 (1cr) CAPACITORS ARE SEMICONDUCTOR CERAMIC, 25Vv,
 UNLESS OTHERWISE NOTED.

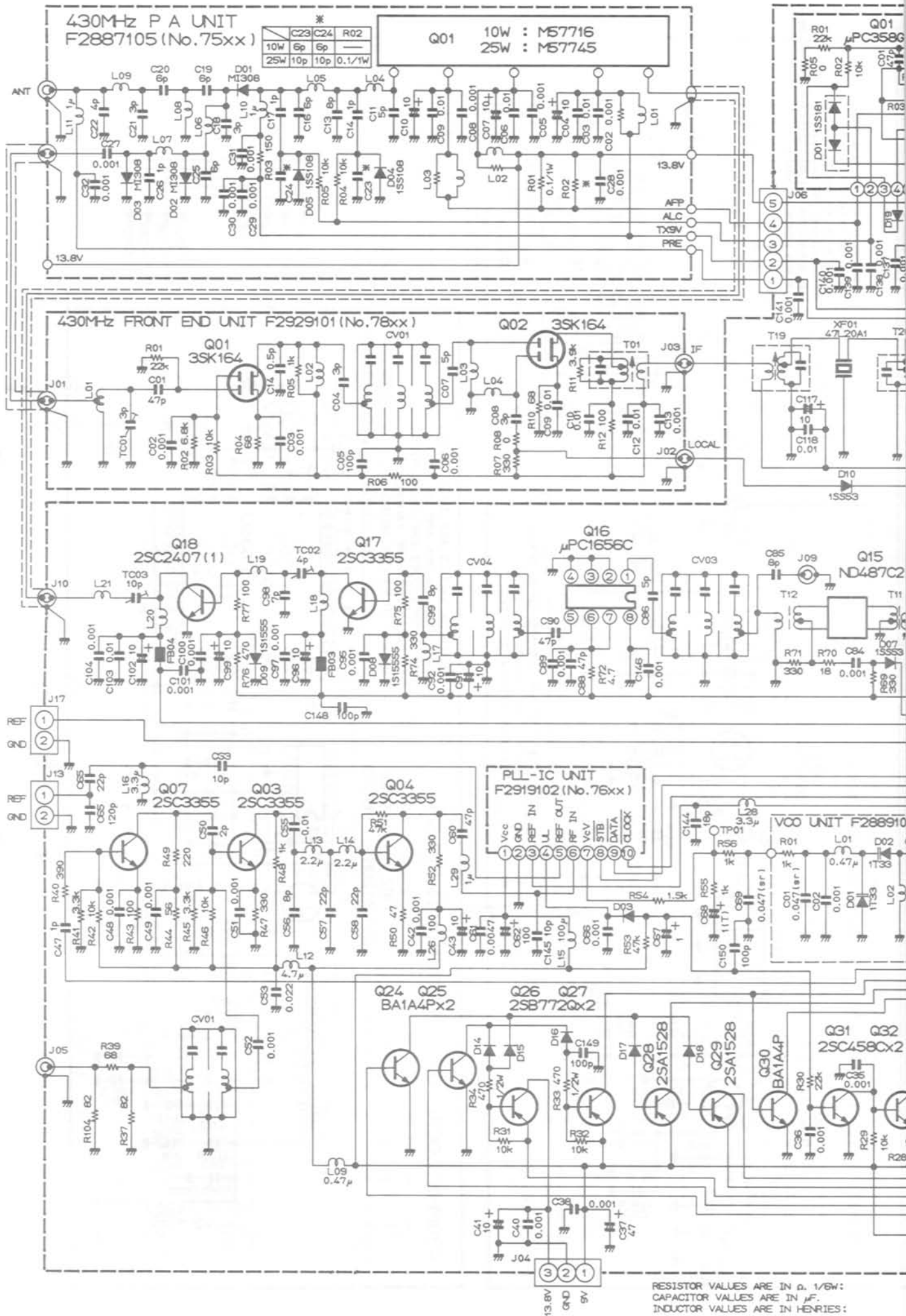

430MHz RF UNIT
F2888102 (No.7xxx)

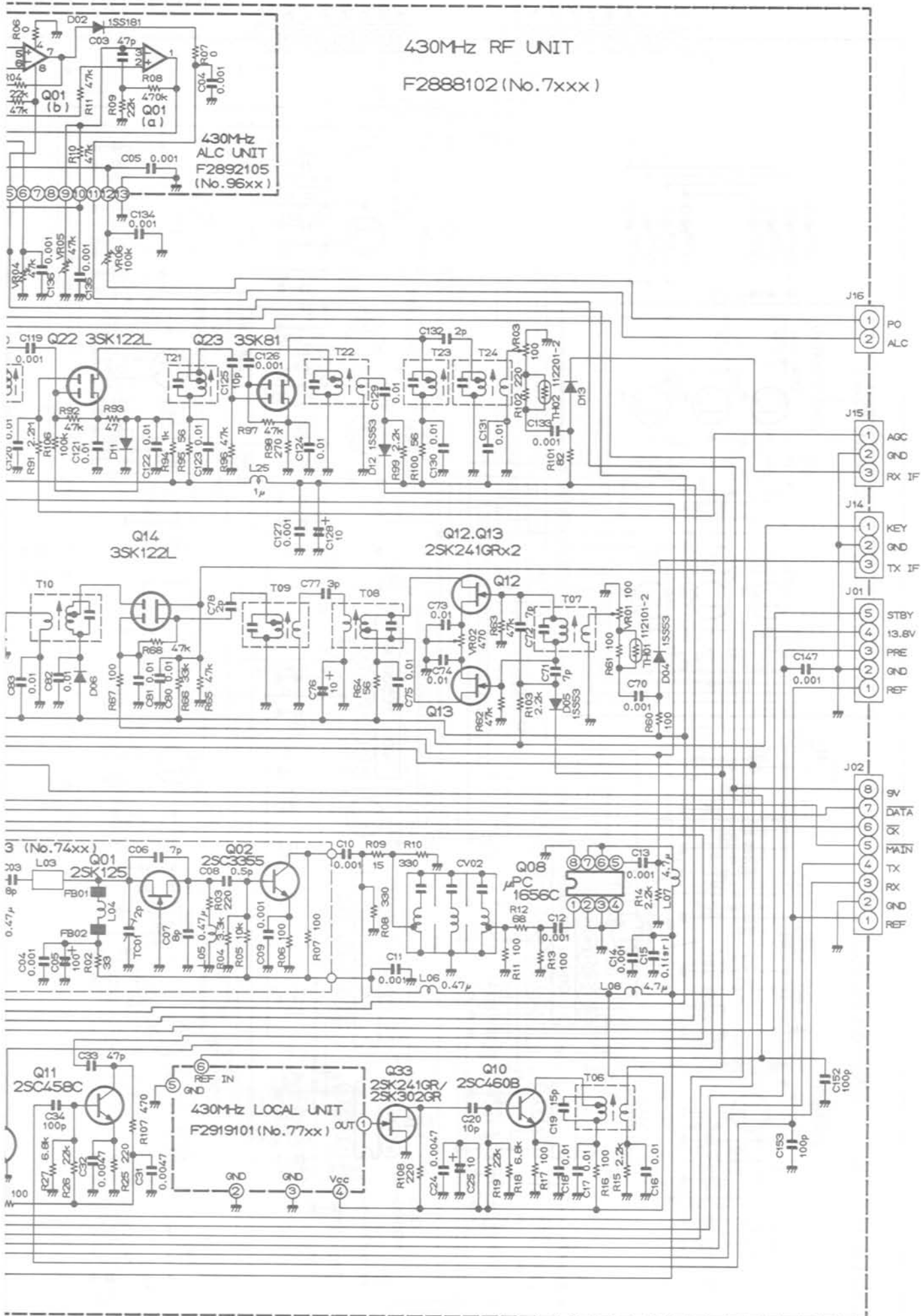

(T) CAPACITORS ARE TANTALUM.
DIODES ARE TYPE 1S5270 UNLESS OTHERWISE NOTED.

430MHz PLL UNIT F2888103 (No. 8xxx)

430MHz SHIFT UNIT F2892108 (No. 92xx)

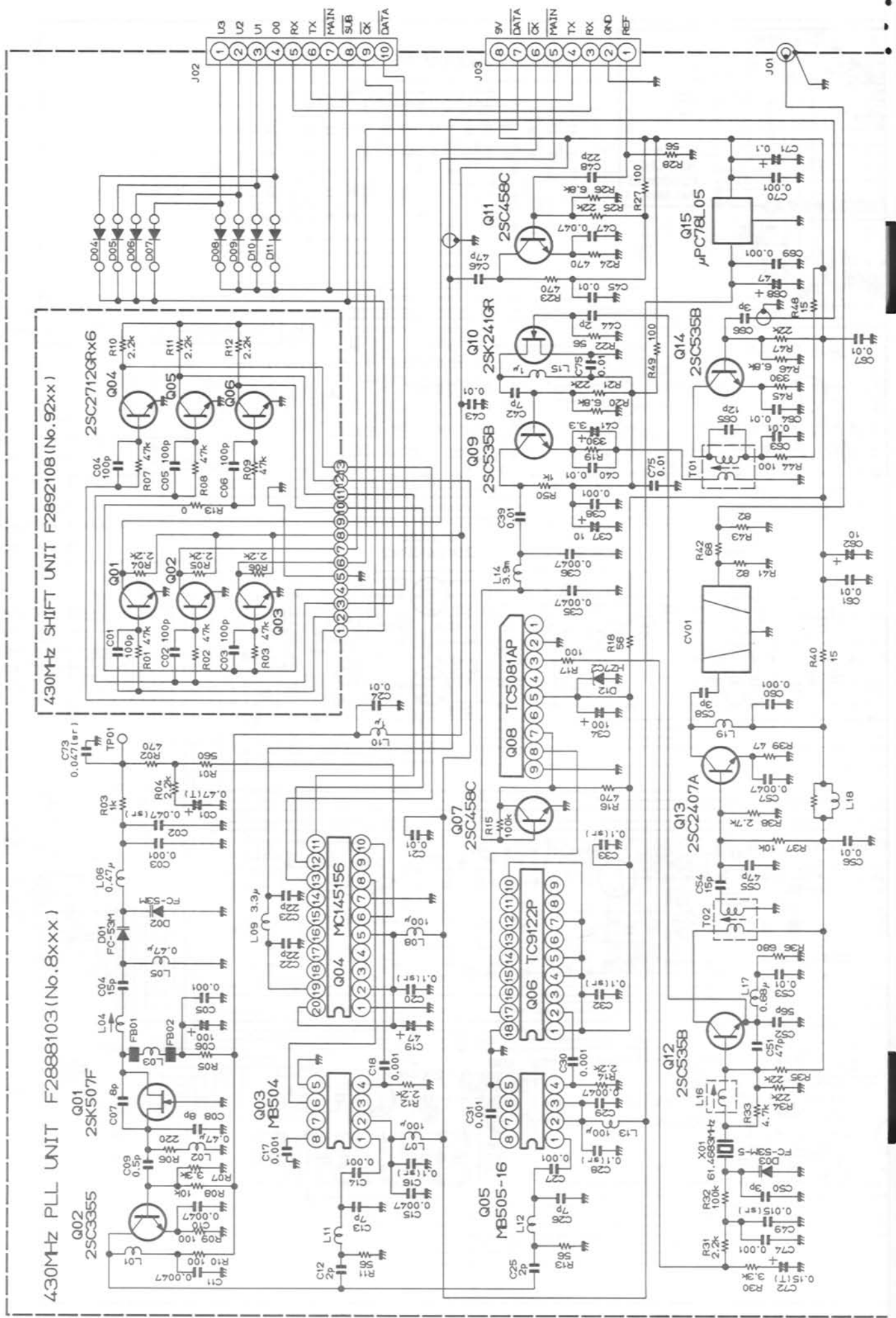

4.30MHz FRONT END UNIT F2929100 (No.78xx)

Q01
3SK164

Q02
3SK164

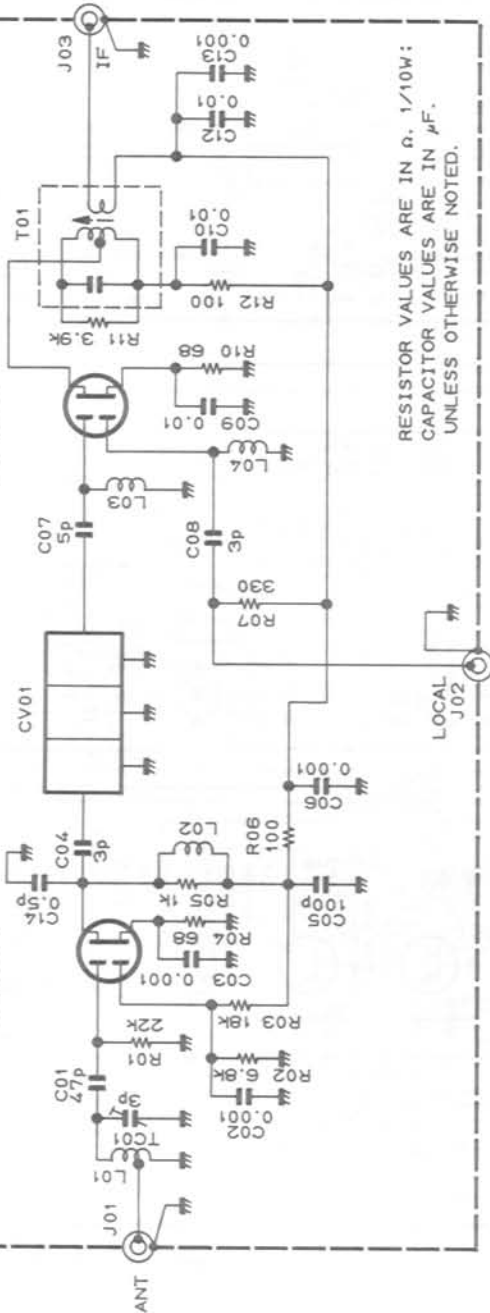

RESISTOR VALUES ARE IN Ω, 1/10W;
CAPACITOR VALUES ARE IN μF.
INDUCTOR VALUES ARE IN HENRIES;
(T) CAPACITORS ARE TANTALUM.
UNLESS OTHERWISE NOTED.

RESISTOR VALUES ARE IN Ω, 1/8W;
CAPACITOR VALUES ARE IN μF.
INDUCTOR VALUES ARE IN HENRIES;
(T) CAPACITORS ARE TANTALUM.
(S) CAPACITORS ARE SEMICONDUCTOR CERAMIC 25WV.
UNLESS OTHERWISE NOTED.

4.30MHz LOCAL UNIT F2919101 (No.77xx)

Q01
2SK210GR

Q02
2SK302GR

Q03
MB503

Q05
2SC2712GR

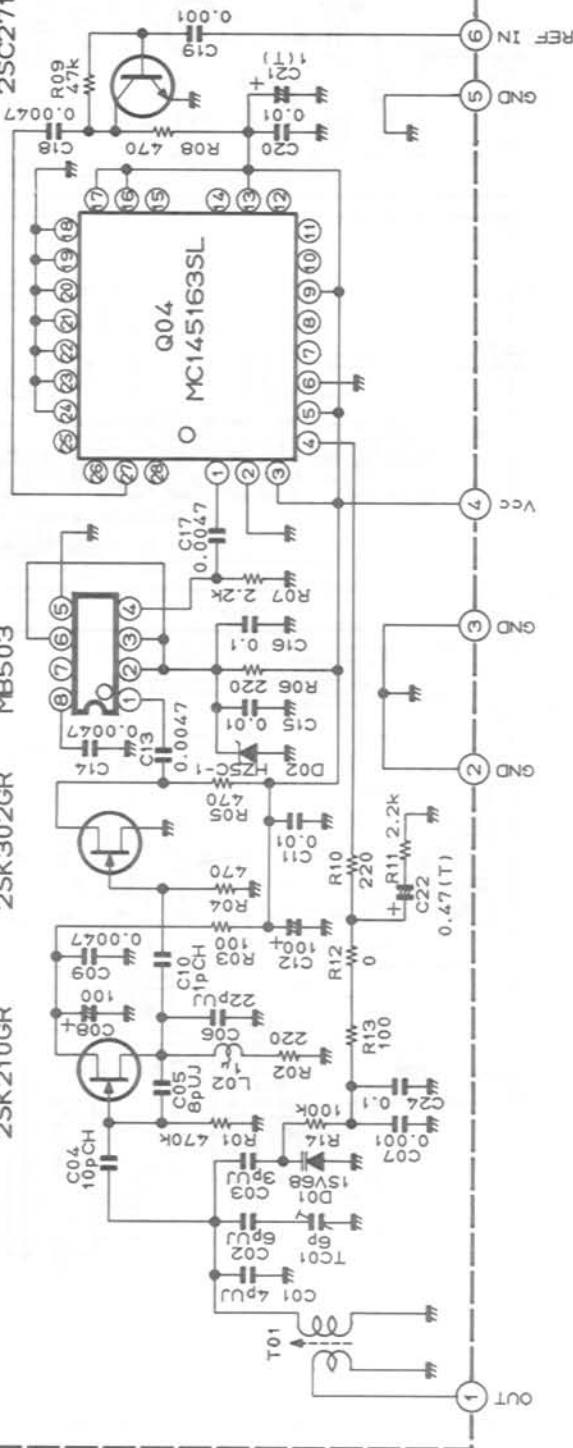

RESISTOR VALUES ARE IN Ω, 1/10W;
CAPACITOR VALUES ARE IN μF.
INDUCTOR VALUES ARE IN HENRIES;
(T) CAPACITORS ARE TANTALUM.
UNLESS OTHERWISE NOTED.

144MHz P A UNIT F2887104 (No.65xx)

144MHz ALC (F2892104 (No.

	C23	C24	R02
10W	8p	8p	—
25W	10p	10p	0.1/1W

Q01 10W : M57713
25W : M57727

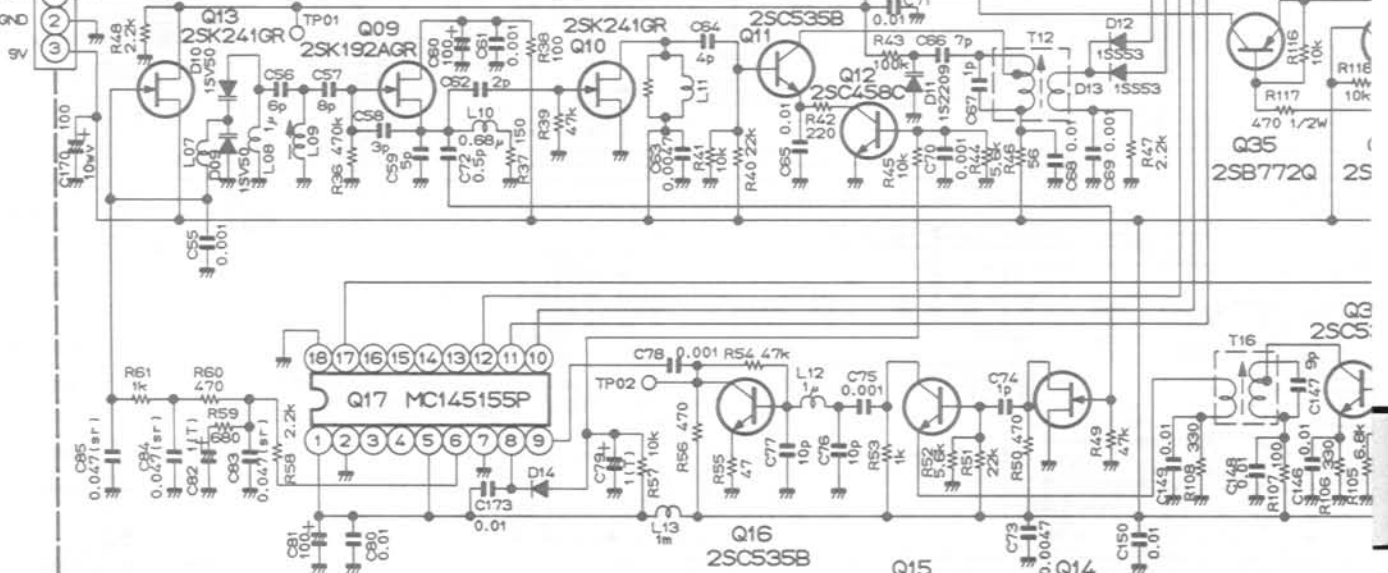
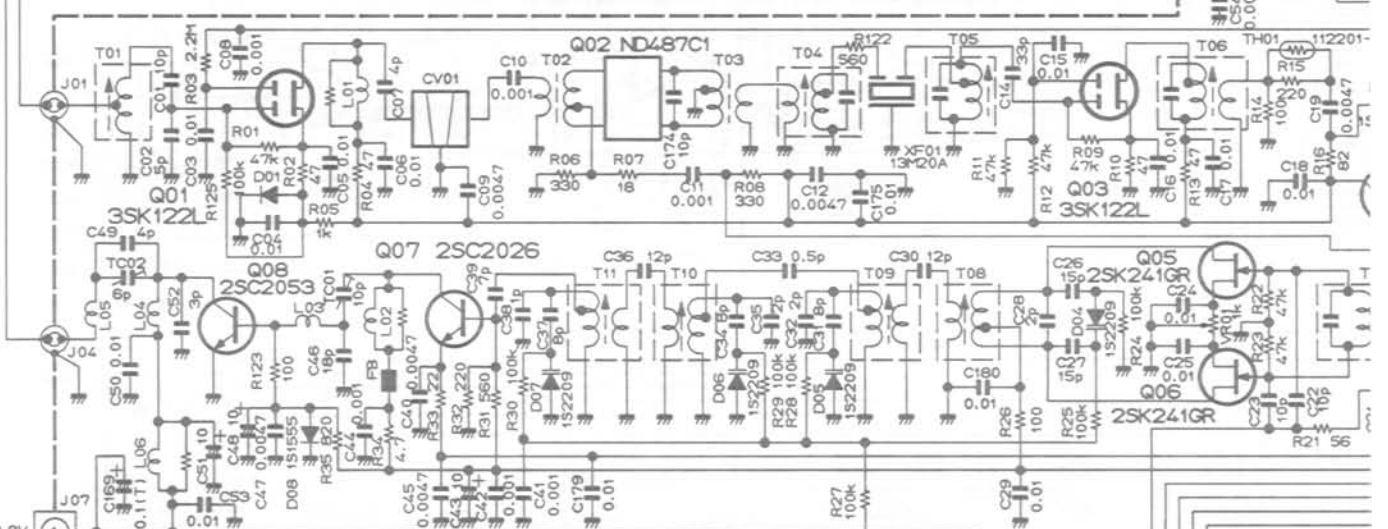
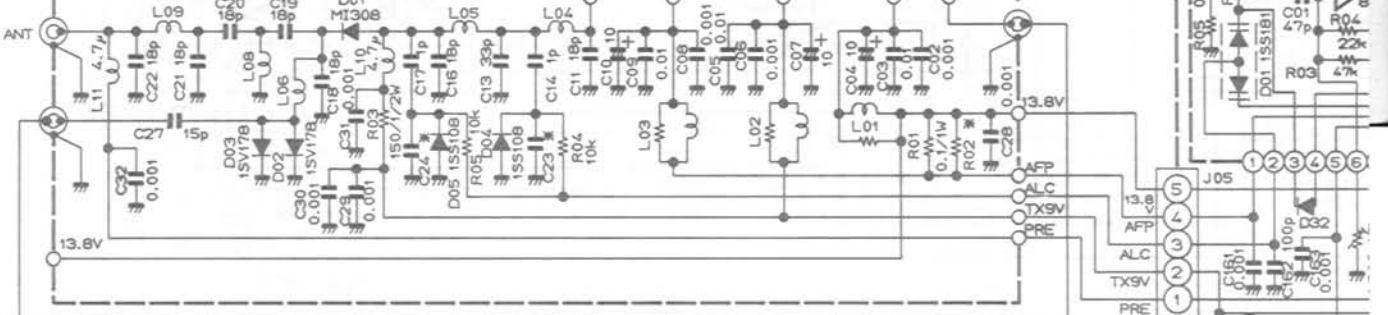

144MHz MAIN UNIT F2888101 (No.6xxx)

RESISTOR VALUES ARE IN Ω , 1/W;
CAPACITOR VALUES ARE IN μ F.
INDUCTOR VALUES ARE IN HENRIES,
UNLESS OTHERWISE NOTED.

DIODES ARE TYPE 1S5270 UNLESS OTHERWISE NOTED.
(T)CAPACITORS ARE TANTALUM.
(sr)CAPACITORS ARE SEMICONDUCTOR CERAMIC. 25wv;

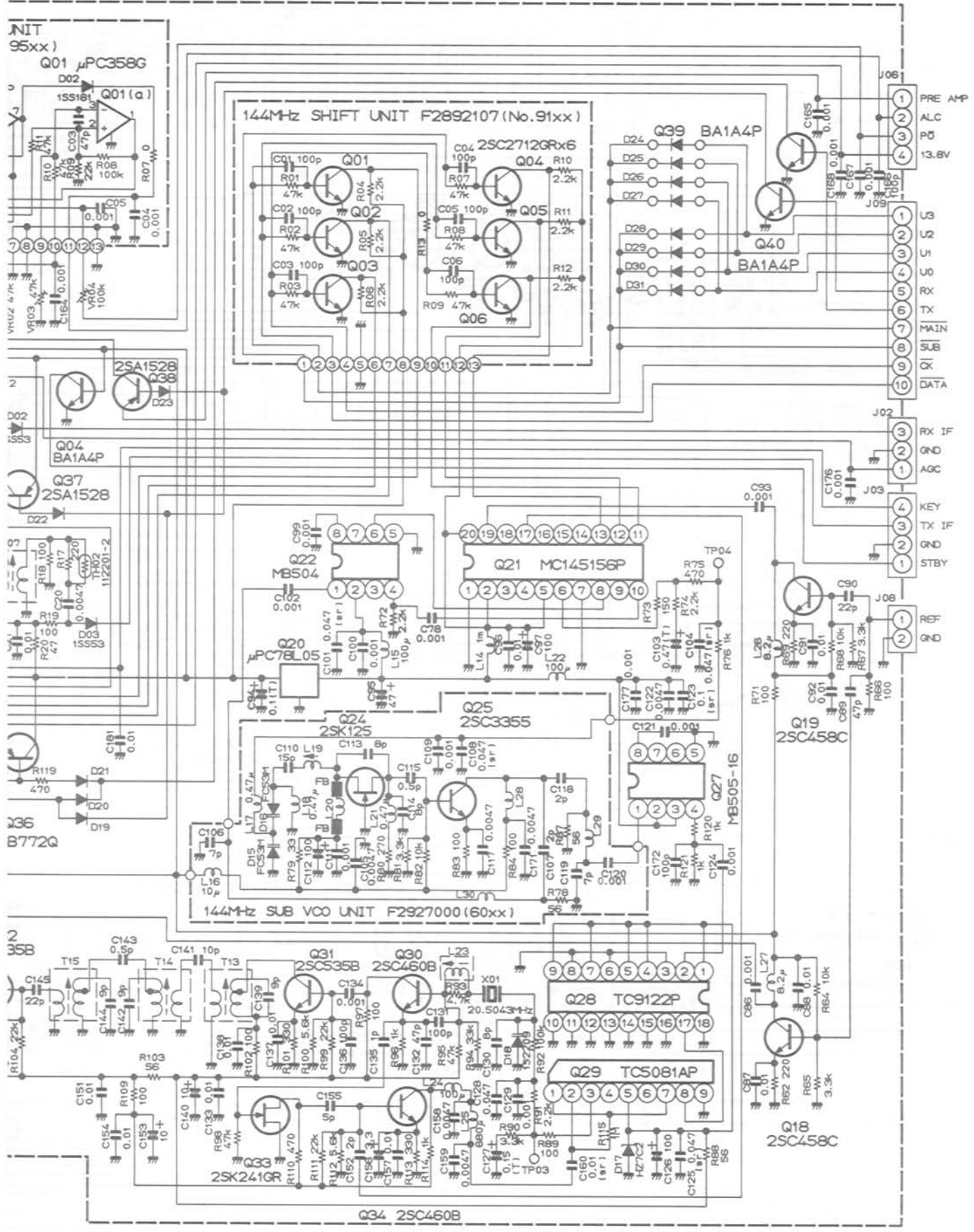

TX UNIT F2887102 (No.4xxx)

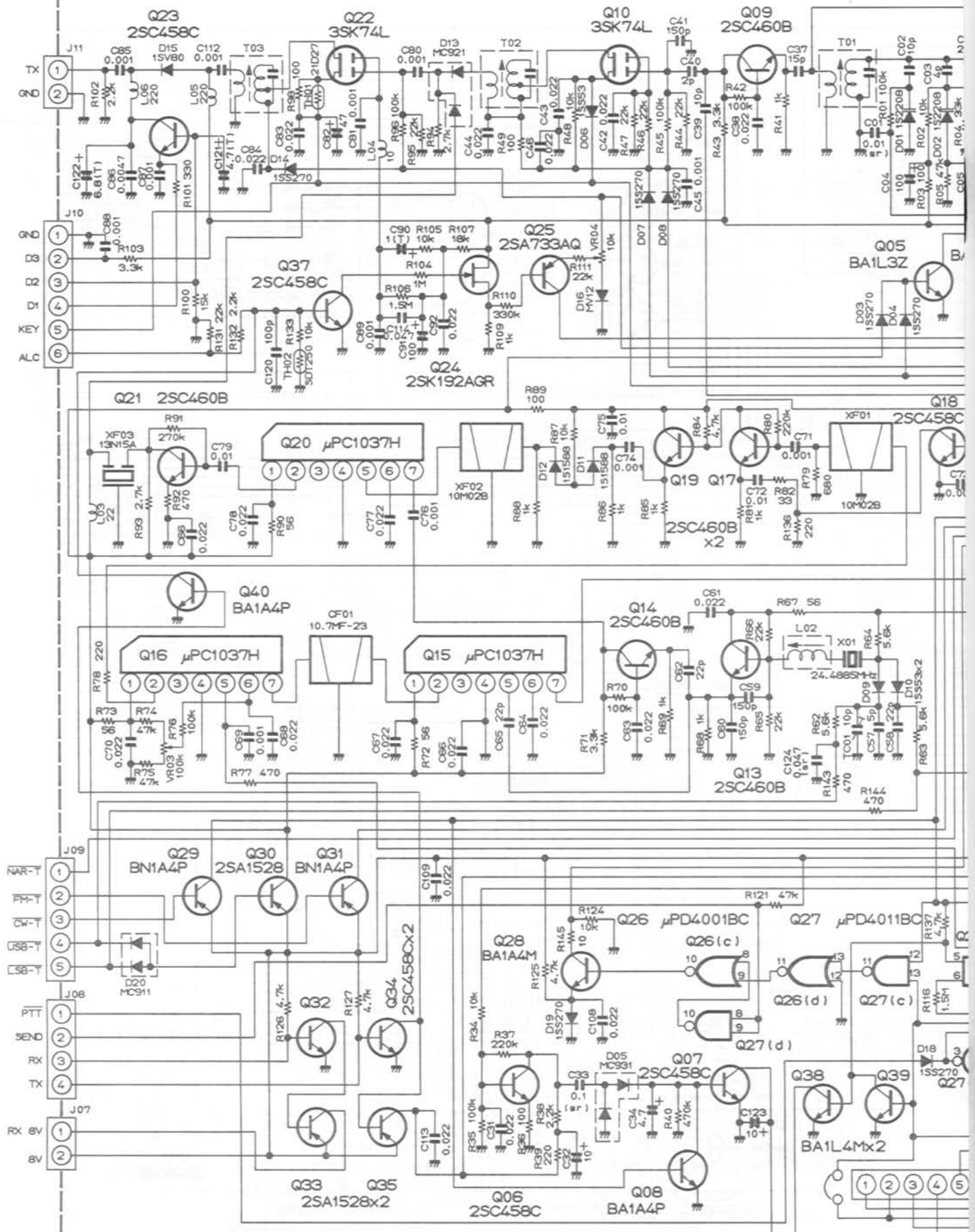

RESISTOR VALUES ARE IN Ω, 1/6W;
 CAPACITOR VALUES ARE IN μF.
 INDUCTOR VALUES ARE IN HENRIES; UNLESS OTHERWISE NOTED.
 (T) CAPACITORS ARE TANTALUM.
 (S) CAPACITORS ARE SEMICONDUCTOR CERAMIC, 25Vv.

